

Approval body for construction products
and types of construction

Bautechnisches Prüfamt

An institution established by the Federal and
Laender Governments



European Technical Assessment

ETA-12/0063
of 15 April 2019

English translation prepared by DIBt - Original version in German language

General Part

Technical Assessment Body issuing the
European Technical Assessment:

Deutsches Institut für Bautechnik

Trade name of the construction product

SFS Self-tapping Screws WT

Product family
to which the construction product belongs

Screws for use in timber constructions

Manufacturer

SFS intec AG
Division Construction
Rosenbergsaustraße 10
9435 HEERBRUGG
SCHWEIZ

Manufacturing plant

HW-1, HW-2

This European Technical Assessment
contains

19 pages including 5 annexes which form an integral part
of this assessment

This European Technical Assessment is
issued in accordance with Regulation (EU)
No 305/2011, on the basis of

EAD 130118-01-0603

This version replaces

ETA-12/0063 issued on 17 July 2018

The European Technical Assessment is issued by the Technical Assessment Body in its official language. Translations of this European Technical Assessment in other languages shall fully correspond to the original issued document and shall be identified as such.

Communication of this European Technical Assessment, including transmission by electronic means, shall be in full. However, partial reproduction may only be made with the written consent of the issuing Technical Assessment Body. Any partial reproduction shall be identified as such.

This European Technical Assessment may be withdrawn by the issuing Technical Assessment Body, in particular pursuant to information by the Commission in accordance with Article 25(3) of Regulation (EU) No 305/2011.

Specific Part

1 Technical description of the product

SFS fasteners WT-T-6,5 and WT-T-8,2 are self-tapping screws made from special carbon steel. WT-S-6,5 are self-tapping screws made from stainless steel. The screws may have an anti-friction coating. The outer thread diameter is not less than 6.5 mm and not greater than 8.2 mm. The overall length of the screw is ranging from 65 mm to 330 mm (nominal dimension). Further dimensions are shown in Annex 5.

All SFS self-tapping screws WT achieve a bending angle α of at least $45/d^{0.7} + 20$, where d is the outer thread diameter of the screws.

2 Specification of the intended use in accordance with the applicable European Assessment Document

The performances given in Section 3 are only valid if the SFS fasteners are used in compliance with the specifications and conditions given in Annex 1 and 2.

The verifications and assessment methods on which this European Technical Assessment is based lead to the assumption of a working life of the screws of at least 50 years. The indications given on the working life cannot be interpreted as a guarantee given by the producer, but are to be regarded only as a means for choosing the right products in relation to the expected economically reasonable working life of the works.

3 Performance of the product and references to the methods used for its assessment

3.1 Mechanical resistance and stability (BWR 1)

Essential characteristic	Performance
Dimensions	See Annex 5
Characteristic yield moment	See Annex 2
Bending angle	See Annex 2
Characteristic withdrawal parameter	See Annex 2
Characteristic head pull-through parameter	See Annex 2
Characteristic tensile strength	See Annex 2
Characteristic yield strength	See Annex 2
Characteristic torsional strength	See Annex 2
Insertion moment	See Annex 2
Spacing, end and edge distances of the screws and minimum thickness of the wood based material	See Annex 2
Slip modulus for mainly axially loaded screws	See Annex 2
Durability against corrosion	See Annex 2

3.2 Safety in case of fire (BWR 2)

Essential characteristic	Performance
Reaction to fire	Class A1

English translation prepared by DIBt

3.3 Safety and accessibility in use (BWR 4)

Same as BWR 1

4 Assessment and verification of constancy of performance (AVCP) system applied, with reference to its legal base

In accordance with EAD No. 130118-00-0603, the applicable European legal act is: 97/176/EC.

The system to be applied is: 3

5 Technical details necessary for the implementation of the AVCP system, as provided for in the applicable EAD

Technical details necessary for the implementation of the AVCP system are laid down in the control plan deposited with Deutsches Institut für Bautechnik.

Issued in Berlin on 15 April 2019 by Deutsches Institut für Bautechnik

BD Dipl.-Ing. Andreas Kummerow
Head of Department

beglaubigt:
Dewitt

Annex 1 Specifications of intended use

A.1.1 Use of the SFS self-tapping screws WT only for:

- Static and quasi-static loads

A.1.2 Base materials

The screws are used for connections in load bearing timber structures between timber members or between those members and steel members:

- Solid timber (softwood) according to EN 14081-1¹,
- Solid timber of ash, beech or oak hardwood according to EN 14081-1,
- Glued laminated timber (softwood) according to EN 14080²,
- Glued laminated timber made of ash, beech or oak hardwood according to European Technical Assessments or national provisions that apply at the installation site,
- Glued solid timber according to EN 14080 or national provisions that apply at the installation site,
- Laminated veneer lumber LVL made of softwood or beech according to EN 14374³,
- Beam BauBuche GL75 according to ETA-14/0354,
- Cross-laminated timber according to European Technical Assessments or national provisions that apply at the installation site.

The screws may be used for connecting the following wood-based panels to the timber members mentioned above:

- Plywood according to EN 636⁴ and EN 13986⁵,
- Oriented Strand Board, OSB according to EN 300⁶ and EN 13986,
- Particleboard according to EN 312⁷ and EN 13986,
- Fibreboards according to EN 622-2⁸, EN 622-3⁹ and EN 13986,
- Cement-bonded particle boards according to EN 634-2¹⁰ and EN 13986,
- Solid-wood panels according to EN 13353¹¹ and EN 13986.

Wood-based panels shall only be arranged on the side of the screw head.

SFS self-tapping screws WT may be used for reinforcing of timber structures perpendicular to the grain.

electronic copy of the eta by dibt: eta-12/0063

1	EN 14081-1:2005+A1:2011	Timber structures – Strength graded structural timber with rectangular cross section – Part 1: General requirements
2	EN 14080:2013	Timber structures - Glued laminated timber and glued solid timber - Requirements
3	EN 14374:2004	Timber structures - Structural laminated veneer lumber - Requirements
4	EN 636:2012+A1:2015	Plywood - Specifications
5	EN 13986:2004+A1:2015	Wood-based panels for use in construction - Characteristics, evaluation of conformity and marking
6	EN 300:2006	Oriented strand boards (OSB) – Definition, classification and specifications
7	EN 312:2010	Particleboards - Specifications
8	EN 622-2:2004	Fibreboards – Specifications – Part 2: Requirements for hardboards
9	EN 622-3:2004	Fibreboards - Specifications - Part 3: Requirements for medium boards
10	EN 634-2:2007	Cement-bonded particleboards – Specifications – Part 2: Requirements for OPC bonded particleboards for use in dry, humid and external conditions
11	EN 13353:2008+A1:2011	Solid wood panels (SWP) – Requirements

SFS Self-tapping Screws WT	Annex 1
Specifications of intended use	

A.1.3 Use Conditions (environmental conditions)

The corrosion protection of the SFS self-tapping screws WT is specified in Annex A.2.6. With regard to the use and the environmental conditions the national provisions of the place of installation apply.

A.1.4 Installation provisions

EN 1995-1-1¹² in conjunction with the respective national annex applies for the installation.

SFS self-tapping screws WT-T and WT-S are either driven into the timber member made of softwood without pre-drilling or in pre-drilled holes with a diameter according to Table A.1.

SFS self-tapping screws WT-T are either driven into timber members made of ash, beech or oak with a maximum mean density of 750 kg/m³ and into timber members made of beech LVL according to EN 14374 or Beam BauBuche GL75 according to ETA-14/0354 with a maximum mean density of 850 kg/m³ without pre-drilling or in pre-drilled holes with a diameter according to Table A.1.

Table A.1 Diameter of the pre-drilled holes

Screw type	Diameter of the pre-drilled hole with a tolerance of ± 0.1 mm [mm]	
	Softwood and LVL made of softwood	Ash, beech or oak hardwood, LVL made from beech or Beam BauBuche GL75 according to ETA-14/0354
WT-S-6,5	3.5	-
WT-T-6,5	3.5	4.5
WT-T-8,2	5.0	6.0 or 7.0

The maximum penetration length of the threaded part of SFS self-tapping screws WT-T in ash, beech or oak and beech LVL and Beam BauBuche GL75 according to ETA-14/0354 is given in Table A.2. If SFS self-tapping screws WT-T are driven in two members, one consisting of ash, beech, oak or beech LVL and the other of spruce, the added penetration length of the thread must not exceed the limit values of Table A.2.

Table A.2 Maximum penetration length of the threaded part of SFS self-tapping screws WT-T in ash, beech, oak or beech LVL/ Beam BauBuche GL75 acc. to ETA-14/0354 or in combinations of ash, beech, oak or beech LVL/ Beam BauBuche GL75 and spruce

Screw type	Diameter of the pre-drilled hole with a tolerance of ± 0.1 mm [mm]	Maximum penetration length of the threaded part of the screws in ash, beech, oak or beech LVL/ Beam BauBuche GL75 [mm]		Maximum penetration length of the threaded part of the screws in combinations of ash, beech, oak or beech LVL/ Beam BauBuche GL75 (max. 40 mm) and spruce [mm]
		With pre-drilling	Without pre-drilling	Without pre-drilling
WT-T-6,5	4.5	220	100	220
WT-T-8,2	6.0	220	70	180
WT-T-8,2	7.0	330	70	180

The screw holes in steel members shall be pre-drilled with an adequate diameter greater than the outer thread diameter.

¹² EN 1995-1-1:2004+A1:2008+A2:2014

Eurocode 5: Design of timber structures – Part 1-1: General - Common rules and rules for buildings

SFS Self-tapping Screws WT	Annex 1
Installation provisions	

A minimum of two screws shall be used for connections in load bearing timber structures. This does not apply for special situations specified in National Annexes to EN 1995-1-1.

If screws with an outer thread diameter $d \geq 8$ mm are driven into the timber member without pre-drilling, the structural solid or glued laminated timber, laminated veneer lumber and glued solid timber members shall be from spruce, pine, fir or ash, beech or oak hardwood or beech LVL/ Beam BauBuche GL75 acc. to ETA-14/0354 considering the maximum penetration length according to Table A.2.

By fastening screws in timber members the head of the screws shall be flush with the surface of the timber member.

SFS Self-tapping Screws WT	Annex 1
Installation provisions	

Annex 2 Characteristic load-bearing capacity values

Table A.2.1 Characteristic load-bearing capacities of SFS self-tapping screws WT

	WT-T-6,5 carbon steel	WT-S-6,5 stainless steel	WT-T-8,2 carbon steel
Outer thread diameter [mm]	6.5	6.5	8.2
Characteristic yield moment $M_{y,k}$ [Nm]	12.5	8.0	25.0
Characteristic tensile strength $f_{tens,k}$ [kN]	12.5	8.5	22.0
Characteristic torsional strength $f_{tor,k}$ [Nm]	12.5	8.5	25.0

A.2.1 General

All SFS self-tapping screws WT achieve a bending angle α of at least $45/d^{0.7} + 20$, where d is the outer thread diameter of the screws.

The minimum penetration length of the threaded part of the screw l_{ef} shall be

$$l_{ef} = \min \left\{ \begin{array}{l} 4 \cdot d \\ \frac{4 \cdot d}{\sin \alpha} \\ 20 \cdot d \end{array} \right. \quad (2.1)$$

where

α angle between screw axis and grain direction

d outer thread diameter of the screw.

The inner thread diameter d_1 of the screws shall be greater than the maximal width of the gaps in the layer of cross laminated timber.

A.2.2 Laterally loaded screws

A.2.2.1 General

The outer thread diameter d shall be used as effective diameter of the screw according to EN 1995-1-1.

The embedding strength for the screws in timber members or in wood-based panels shall be taken from EN 1995-1-1 or from national provisions that apply at the installation site.

A.2.2.2 Solid timber, glued laminated timber and glued solid timber

The embedding strength for screws in non-pre-drilled holes in softwood or in ash, beech or oak hardwood arranged at an angle between screw axis and grain direction of $0^\circ \leq \alpha \leq 90^\circ$ is:

$$f_{h,k} = \frac{0.082 \cdot \rho_k \cdot d^{-0.3}}{2.5 \cdot \cos^2 \alpha + \sin^2 \alpha} \quad [\text{N/mm}^2] \quad (2.2)$$

SFS Self-tapping Screws WT	Annex 2
Characteristic load-bearing capacity values	

English translation prepared by DIBt

The embedding strength for screws in pre-drilled holes in softwood or in ash, beech or oak hardwood arranged at an angle between screw axis and grain direction of $0^\circ \leq \alpha \leq 90^\circ$ is:

$$f_{h,k} = \frac{0.082 \cdot \rho_k \cdot (1 - 0.01 \cdot d)}{2.5 \cdot \cos^2 \alpha + \sin^2 \alpha} \quad [\text{N/mm}^2] \quad (2.3)$$

where

- ρ_k Characteristic density of the timber member, for ash, beech and oak $\rho_k \leq 590 \text{ kg/m}^3$,
- d Outer thread diameter of the screw [mm]
- α Angle between screw axis and grain direction, $0^\circ \leq \alpha \leq 90^\circ$.

A.2.2.3 Laminated veneer lumber

The embedding strength for screws in non-pre-drilled holes in softwood LVL arranged at an angle between screw axis and grain direction, $0^\circ \leq \alpha \leq 90^\circ$ is:

$$f_{h,k} = \frac{0.082 \cdot \rho_k \cdot d^{-0.3}}{(2.5 \cdot \cos^2 \alpha + \sin^2 \alpha)(1.5 \cdot \cos^2 \beta + \sin^2 \beta)} \quad [\text{N/mm}^2] \quad (2.4)$$

and accordingly for screws in pre-drilled holes in softwood LVL arranged at an angle between screw axis and grain direction, $0^\circ \leq \alpha \leq 90^\circ$:

$$f_{h,k} = \frac{0.082 \cdot \rho_k \cdot (1 - 0.01 \cdot d)}{(2.5 \cdot \cos^2 \alpha + \sin^2 \alpha)(1.5 \cdot \cos^2 \beta + \sin^2 \beta)} \quad [\text{N/mm}^2] \quad (2.5)$$

Where

- ρ_k characteristic timber density of the softwood LVL [kg/m^3], $\rho_k \leq 500 \text{ kg/m}^3$,
- d outer thread diameter of the screw [mm],
- α angle between screw axis and grain direction ($0^\circ \leq \alpha \leq 90^\circ$),
- β angle between screw axis and the LVL's wide face ($0^\circ \leq \beta \leq 90^\circ$).

The embedding strength for screws in pre-drilled or in non-pre-drilled holes in beech LVL according to EN 14374 or in Beam BauBuche GL75 according to ETA-14/0354 arranged at an angle between screw axis and grain direction, $0^\circ \leq \alpha \leq 90^\circ$ is:

$$f_{h,k} = \frac{0.082 \cdot \rho_k \cdot d^{-0.15}}{(2.5 \cdot \cos^2 \alpha + \sin^2 \alpha) \cdot k_\epsilon \cdot k_\beta} \quad [\text{N/mm}^2] \quad (2.6)$$

Where

- ρ_k characteristic density of beech LVL or Beam BauBuche GL75 [kg/m^3], $590 \text{ kg/m}^3 \leq \rho_k \leq 750 \text{ kg/m}^3$
- d outer thread diameter of the screw [mm],
- α angle between screw axis and grain direction, $0^\circ \leq \alpha \leq 90^\circ$,

$$k_\epsilon = (0.5 + 0.024 \cdot d) \cdot \sin^2 \epsilon + \cos^2 \epsilon, \quad (2.7)$$

- ϵ angle between load and grain direction, $0^\circ \leq \epsilon \leq 90^\circ$,

$$k_\beta = 1.2 \cdot \cos^2 \beta + \sin^2 \beta, \quad (2.8)$$

- β angle between screw axis and wide face of LVL or Beam BauBuche GL75 member, $0^\circ \leq \beta \leq 90^\circ$.

SFS Self-tapping Screws WT	Annex 2
Characteristic values of the load-carrying capacities	

A.2.2.4 Cross laminated timber

The embedding strength for screws arranged in the edge surfaces parallel to the plane of cross laminated timber may be assumed according to equation (2.9) independent of the angle between screw axis and grain direction, $0^\circ \leq \alpha \leq 90^\circ$:

$$f_{h,k} = 20 \cdot d^{-0,5} \text{ in N/mm}^2 \quad (2.9)$$

unless otherwise specified in the technical specification of the cross laminated timber.

Where d is the outer thread diameter of the screws in mm.

Equation (2.9) is only valid for softwood layers. The provisions in the European Technical Assessment or in national provisions of the cross laminated timber apply.

The embedding strength for screws in the wide face of cross laminated timber should be assumed as for solid timber based on the characteristic density of the outer layer. Where applicable, the angle between force and grain direction of the outer layer shall be taken into account. The direction of the lateral force shall be perpendicular to the screw axis and parallel to the wide face of the cross laminated timber.

A.2.3 Axially loaded screws

A.2.3.1 Axial slip modulus

The axial slip modulus K_{ser} of the threaded part of a screw for the serviceability limit state per side shall be taken independent of angle α to the grain as:

$$K_{ser} = 25 \cdot l_{ef} \cdot d \quad [\text{N/mm}] \quad \text{for timber members made of softwood} \quad (2.10)$$

$$K_{ser} = 30 \cdot l_{ef} \cdot d \quad [\text{N/mm}] \quad \text{for timber members made of ash, beech or oak} \quad (2.11)$$

where

d outer thread diameter of the screw [mm]

l_{ef} penetration length of the threaded part of the screw in the timber member [mm].

A.2.3.2 Axial withdrawal capacity – Characteristic withdrawal parameter

The characteristic withdrawal capacity in solid timber (softwood or hardwood species ash, beech and oak), glued laminated timber (softwood or hardwood species ash, beech and oak), cross laminated timber or laminated veneer lumber members made of softwood or beech or Beam BauBuche GL75 according to ETA-14/0354 at an angle of $0^\circ \leq \alpha \leq 90^\circ$ to the grain shall be calculated as:

$$F_{ax,\alpha,Rk} = \frac{n_{ef} \cdot k_{ax} \cdot f_{ax,k} \cdot d \cdot l_{ef}}{k_{\beta}} \cdot \left(\frac{\rho_k}{\rho_a} \right)^{0,8} \quad (2.12)$$

where

$F_{ax,\alpha,Rk}$ Characteristic withdrawal capacity of a screw group at an angle α to the grain [N]

n_{ef} Effective number of screws according to EN 1995-1-1, clause 8.7.2 (8)

k_{ax} Factor, taking into account the angle α between screw axis and grain direction

$$k_{ax} = 1.0 \quad \text{for } 45^\circ \leq \alpha \leq 90^\circ$$

$$k_{ax} = a + \frac{b \cdot \alpha}{45^\circ} \quad \text{for } 0^\circ \leq \alpha < 45^\circ \quad (2.13)$$

$$a = \begin{cases} 0.5 & \text{for LVL} \\ 0.3 & \text{for solid timber, glued solid timber, glued laminated timber and cross laminated timber} \end{cases}$$

$$b = \begin{cases} 0.5 & \text{for LVL} \\ 0.7 & \text{for solid timber, glued solid timber, glued laminated timber and cross laminated timber} \end{cases}$$

SFS Self-tapping Screws WT	Annex 2
Characteristic values of the load-carrying capacities	

Equation (2.12) may be used for angles α between screw axis and grain direction $0^\circ \leq \alpha < 15^\circ$ if the following requirements are fulfilled:

1. The screws are inserted in solid timber, glued laminated timber, glued solid timber or laminated veneer lumber made from softwood or beech.
2. The penetration length of the threaded part of the screws is

$$l_{ef,req} = \min \left\{ \begin{array}{l} \frac{4 \cdot d}{\sin \alpha} \\ 20 \cdot d \end{array} \right.$$

3. At least four screws are used in a connection.

$$k_\beta \quad k_\beta = 1.0 \quad \text{for solid timber, glued solid timber and glued laminated timber} \\ k_\beta = 1.5 \cdot \cos^2 \beta + \sin^2 \beta \quad \text{for laminated veneer lumber} \quad (2.14)$$

$f_{ax,k}$ Characteristic withdrawal parameter at an angle $\alpha = 90^\circ$

- solid timber, glued solid timber, glued laminated timber, cross laminated timber and laminated veneer lumber made of softwood members with $\rho_a = 350 \text{ kg/m}^3$

$$f_{ax,k} = 12.8 \text{ N/mm}^2$$

The characteristic withdrawal parameter is also valid for softwood layers of cross-laminated timber.

- beech LVL or Beam BauBuche GL75 (ETA-14/0354) members with $\rho_a = 730 \text{ kg/m}^3$

$$f_{ax,k} = 35.0 \text{ N/mm}^2 \quad \text{for SFS WT-T screws in non-predrilled members and for the head thread of screws WT-T-8,2 in pre-drilled members}$$

$$f_{ax,k} = 30.0 \text{ N/mm}^2 \quad \text{for SFS WT-T-6,5 screws and for the tip thread of WT-T-8,2 screws in pre-drilled holes with a diameter of 6 mm}$$

$$f_{ax,k} = 25.0 \text{ N/mm}^2 \quad \text{for the tip thread of WT-T-8,2 screws in pre-drilled holes with a diameter of 7 mm}$$

d outer thread diameter of the screw [mm]

l_{ef} penetration length of the threaded part of the screw [mm]

α angle between grain and screw axis ($0^\circ \leq \alpha \leq 90^\circ$)

β angle between screw axis and the LVL's wide face ($0^\circ \leq \beta \leq 90^\circ$)

ρ_k characteristic density of the timber member [kg/m^3] for softwood LVL $\rho_k \leq 500 \text{ kg/m}^3$, for hardwood $\rho_k \leq 590 \text{ kg/m}^3$, for beech LVL $590 \text{ kg/m}^3 \leq \rho_k \leq 750 \text{ kg/m}^3$

ρ_a associated density for $f_{ax,k}$ [kg/m^3]

For screws penetrating more than one layer of cross laminated timber the different layers may be taken into account proportionally. In the lateral surfaces of the cross laminated timber the screws shall be fully inserted in one layer of cross-laminated timber.

SFS Self-tapping Screws WT	Annex 2
Characteristic values of the load-carrying capacities	

A.2.3.3 Head pull-through capacity – Characteristic head pull-through parameter

The characteristic value of the head pull-through parameter for SFS screws for solid timber (softwood or hardwood species ash, beech and oak), glued laminated timber (softwood or hardwood species ash, beech and oak), cross laminated timber, laminated veneer lumber members made of softwood or beech and wood-based panels like

- Plywood according to EN 636 and EN 13986
- Oriented Strand Board, OSB according to EN 300 and EN 13986
- Particleboard according to EN 312 and EN 13986
- Fibreboards according to EN 622-2, EN 622-3 and EN 13986
- Cement-bonded particle boards according to EN 634-2 and EN 13986,
- Solid-wood panels according to EN 13353 and EN 13986

with a thickness of more than 20 mm and for $\rho_a = 350 \text{ kg/m}^3$ is

$$f_{\text{head,k}} = 10.0 \text{ N/mm}^2.$$

For wood-based panels a maximum characteristic density of 380 kg/m^3 , for softwood LVL a maximum characteristic density of 500 kg/m^3 , for hardwood a maximum characteristic density of 590 kg/m^3 and for beech LVL a maximum characteristic density of 730 kg/m^3 shall be used in equation (8.40b) of EN 1995-1-1.

For wood based panels with a thickness $12 \text{ mm} \leq t \leq 20 \text{ mm}$ the characteristic value of the head pull-through parameter for SFS screws is:

$$f_{\text{head,k}} = 8 \text{ N/mm}^2$$

For wood based panels with a thickness of less than 12 mm the characteristic head pull-through capacity for SFS screws shall be based on a characteristic value of the head pull-through parameter of 8 N/mm^2 , and limited to 400 N complying with the minimum thickness of the wood based panels of $1.2 \cdot d$, with d as outer thread diameter and the values in Table A.2.2.

Table A.2.2 Minimum thickness of wood based panels

Wood based panel	Minimum thickness [mm]
Plywood	6
Fibreboards (hardboards and medium boards)	6
Oriented Strand Boards, OSB	8
Particleboards	8
Cement-bonded particle board	8
Solid wood Panels	12

For SFS screws WT the withdrawal capacity of the thread in the timber member with the screw head may be taken into account instead of the head pull-through capacity.

In steel-to-timber connections the head pull-through capacity is not governing.

SFS Self-tapping Screws WT	Annex 2
Characteristic load-bearing capacity values	

A.2.3.4 Compressive capacity of SFS self-tapping screws WT - Characteristic yield strength

The design axial capacity $F_{ax,Rd}$ of SFS self-tapping screws WT embedded in solid timber, glued solid timber or glued laminated timber made from softwood with an angle between screw axis and grain direction of $30^\circ \leq \alpha \leq 90^\circ$ is the minimum of the axial resistance against pushing-in and the buckling resistance of the screw.

$$F_{ax,Rd} = \min \{k_{ax} \cdot f_{ax,d} \cdot d \cdot l_{ef}; \kappa_c \cdot N_{pl,d}\} \quad (2.15)$$

k_{ax} Factor, taking into account the angle α between screw axis and grain direction according to clause A.2.3.2

$f_{ax,d}$ design value of the axial withdrawal capacity of the threaded part of the screw [N/mm²]

d outer thread diameter of the screw [mm]

l_{ef} penetration length of the threaded part of the screw in the timber member [mm]

$$\kappa_c = 1 \quad \text{for } \bar{\lambda}_k \leq 0,2 \quad (2.16)$$

$$\kappa_c = \frac{1}{k + \sqrt{k^2 - \bar{\lambda}_k^2}} \quad \text{for } \bar{\lambda}_k > 0,2 \quad (2.17)$$

$$k = 0,5 \cdot \left[1 + 0,49 \cdot (\bar{\lambda}_k - 0,2) + \bar{\lambda}_k^2 \right] \quad (2.18)$$

and a relative slenderness ratio $\bar{\lambda}_k = \sqrt{\frac{N_{pl,k}}{N_{ki,k}}}$ (2.19)

where:

$N_{pl,k}$ characteristic plastic normal force related to the net cross-section of the inner thread diameter:

$$N_{pl,k} = \pi \cdot \frac{d_1^2}{4} \cdot f_{y,k} \quad (2.20)$$

$f_{y,k}$ characteristic yield strength, $f_{y,k} = 870$ N/mm² for SFS screws WT-T
 $f_{y,k} = 550$ N/mm² for SFS screws WT-S

d_1 inner thread diameter of the screw [mm]

$$N_{pl,d} = \frac{N_{pl,k}}{\gamma_{M1}} \quad (2.21)$$

γ_{M1} partial factor according to EN 1993-1-1 in conjunction with the particular national annex

characteristic ideal elastic buckling load:

$$N_{ki,k} = \sqrt{c_h \cdot E_s \cdot I_s} \quad [\text{N}] \quad (2.22)$$

elastic foundation of the screw:

$$c_h = (0,19 + 0,012 \cdot d) \cdot \rho_k \cdot \left(\frac{90^\circ + \alpha}{180^\circ} \right) \quad [\text{N/mm}^2] \quad (2.23)$$

ρ_k characteristic density of the timber member [kg/m³],

α angle between screw axis and grain direction, $30^\circ \leq \alpha \leq 90^\circ$

modulus of elasticity:

$$E_s = 210.000 \text{ N/mm}^2$$

second moment of area:

$$I_s = \frac{\pi \cdot d_1^4}{64} \quad [\text{mm}^4] \quad (2.24)$$

SFS Self-tapping Screws WT	Annex 2
Characteristic values of the load-carrying capacities	

A.2.4 Spacing, end and edge distances of the screws and minimum thickness of the wood based material

A.2.4.1 Laterally and/or axially loaded screws

Screws in pre-drilled holes

For SFS self-tapping screws WT in pre-drilled holes the minimum spacings, end and edge distances are given in EN 1995-1-1, clause 8.3.1.2 and Table 8.2 as for nails in pre-drilled holes. Here, the outer thread diameter d shall be considered.

Minimum thickness for structural timber members made from solid timber, glued laminated timber, glued solid timber, laminated veneer lumber and cross laminated timber is $t = 30$ mm for screws with $d = 6.5$ mm and $t = 40$ mm for screws with $d = 8.2$ mm.

Screws in non pre-drilled holes

For SFS self-tapping screws WT minimum spacing and distances are given in EN 1995-1-1, clause 8.3.1.2 and Table 8.2 as for nails in non-predrilled holes. Here, the outer thread diameter d shall be considered.

For Douglas fir members minimum spacing and distances parallel to the grain shall be increased by 50%.

Minimum distances from the unloaded edge perpendicular to the grain may be reduced to $3 \cdot d$ also for timber thickness $t < 5 \cdot d$, if the spacing parallel to the grain and the end distance is at least $25 \cdot d$.

A.2.4.2 Only axially loaded screws

For SFS self-tapping screws WT loaded only axially, the following minimum spacings, end and edge distances apply alternatively to clause A.2.4.1 for solid timber, glued solid timber and glued laminated timber made of softwood:

Spacing a_1 in a plane parallel to grain: $a_1 = 12 \cdot d$

Spacing a_2 perpendicular to a plane parallel to grain: $a_2 = 3 \cdot d$

End distance of the centre of gravity of the threaded part in the timber member: $a_{1,CG} = 8 \cdot d$

Edge distance of the centre of gravity of the threaded part in the timber member: $a_{2,CG} = 3 \cdot d$

For screws in non pre-drilled holes a minimum timber thickness of $10 d$ is required.

For a crossed screw couple in solid timber, glued laminated timber and similar glued products or in laminated veneer lumber the minimum spacing between the crossing screws may be reduced by the factor $(1 - \alpha_k/180^\circ)$ with $0^\circ \leq \alpha_k \leq 90^\circ$, where α_k is the crossing angle of the screws. The minimum spacing shall be at least $1.5 d$. Appropriate means have to ensure that the crossed screws threads do not touch each other when being inserted in the timber member.

Are the spacing, end and edge distances less than the distances and thicknesses given in EN 1995-1-1 the verification of resistance according to EN 1995-1-1, clause 8.7.2 (1) the failure along the circumference of a group of screws has to be considered also for connections without steel plates.

A.2.5 Insertion moment

The ratio between the characteristic torsional strength $f_{tor,k}$ and the mean value of insertion moment $R_{tor,mean}$ fulfills the requirement for all screws.

A.2.6 Durability against corrosion

The screws are coated with the zinc flake system "Durocoat" or they are electrogalvanized (minimum thickness: 5μ) or they are zinc-nickel coated (minimum thickness: 8μ).

Steel no. 1.4301, 1.4462, 1.4539, 1.4529, 1.4567 or 1.4578 are used for screws WT-S-6,5.

SFS Self-tapping Screws WT	Annex 2
Spacing and distances, insertion moment and durability against corrosion	

ANNEX 3 Compression reinforcement perpendicular to the grain

A.3.1 General

SFS self-tapping screws WT may be used for compression reinforcement perpendicular to the grain. The provisions are valid for reinforcing timber members made from solid timber, glued solid timber or glued laminated timber made of softwood.

The compression force shall evenly be distributed to the screws used as compression reinforcement.

The screws are driven into the timber member perpendicular to the contact surface under an angle between the screw axis and the grain direction of 45° to 90°. The screw heads must be flush with the timber surface.

A.3.2 Design

For the design of reinforced contact areas the following conditions must be met independently of the angle between the screw axis and the grain direction.

The design resistance of a reinforced contact area is:

$$R_{90,d} = \min \left\{ \begin{array}{l} k_{c,90} \cdot B \cdot l_{ef,1} \cdot f_{c,90,d} + n \cdot \min\{R_{ax,d}; \kappa_c \cdot N_{pl,d}\} \\ B \cdot l_{ef,2} \cdot f_{c,90,d} \end{array} \right. \quad (3.1)$$

where:

$k_{c,90}$ Parameter according to EN 1995-1-1, clause 6.1.5

B Bearing width [mm]

$l_{ef,1}$ Effective contact length according to EN 1995-1-1, clause 6.1.5 [mm]

$f_{c,90,d}$ Design compressive strength perpendicular to the grain [N/mm²]

n Number of reinforcing screws, $n = n_0 \cdot n_{90}$

n_0 Number of reinforcing screws arranged in a row parallel to the grain

n_{90} Number of reinforcing screws arranged in a row perpendicular to the grain

$R_{ax,d} = f_{ax,d} \cdot d \cdot l_{ef}$ [N] (3.2)

$f_{ax,d}$ design value of the axial withdrawal capacity of the threaded part of the screw [N/mm²]

d outer thread diameter of the screw [mm]

κ_c according to annex A.2.3.4,

$N_{pl,d}$ according to annex A.2.3.4 [N]

$l_{ef,2}$ Effective contact length in the plane of the screw tips (see Figure A.3.1) [mm]

$l_{ef,2} = \{l_{ef} + (n_0 - 1) \cdot a_1 + \min(l_{ef}; a_{1,CG})\}$ for end supports (see Figure A.3.1 left)

$l_{ef,2} = \{2 \cdot l_{ef} + (n_0 - 1) \cdot a_1\}$ for intermediate supports (see Figure A.3.1 right)

l_{ef} Penetration length of the threaded part of the screw in the timber member [mm]

a_1 Spacing a_1 in a plane parallel to grain, see chapter A.2.4.2 [mm]

$a_{1,CG}$ End distance of the centre of gravity of the threaded part in the timber member, see chapter A.2.4.2 [mm]

SFS Self-tapping Screws WT	Annex 3
Compression reinforcement perpendicular to the grain	

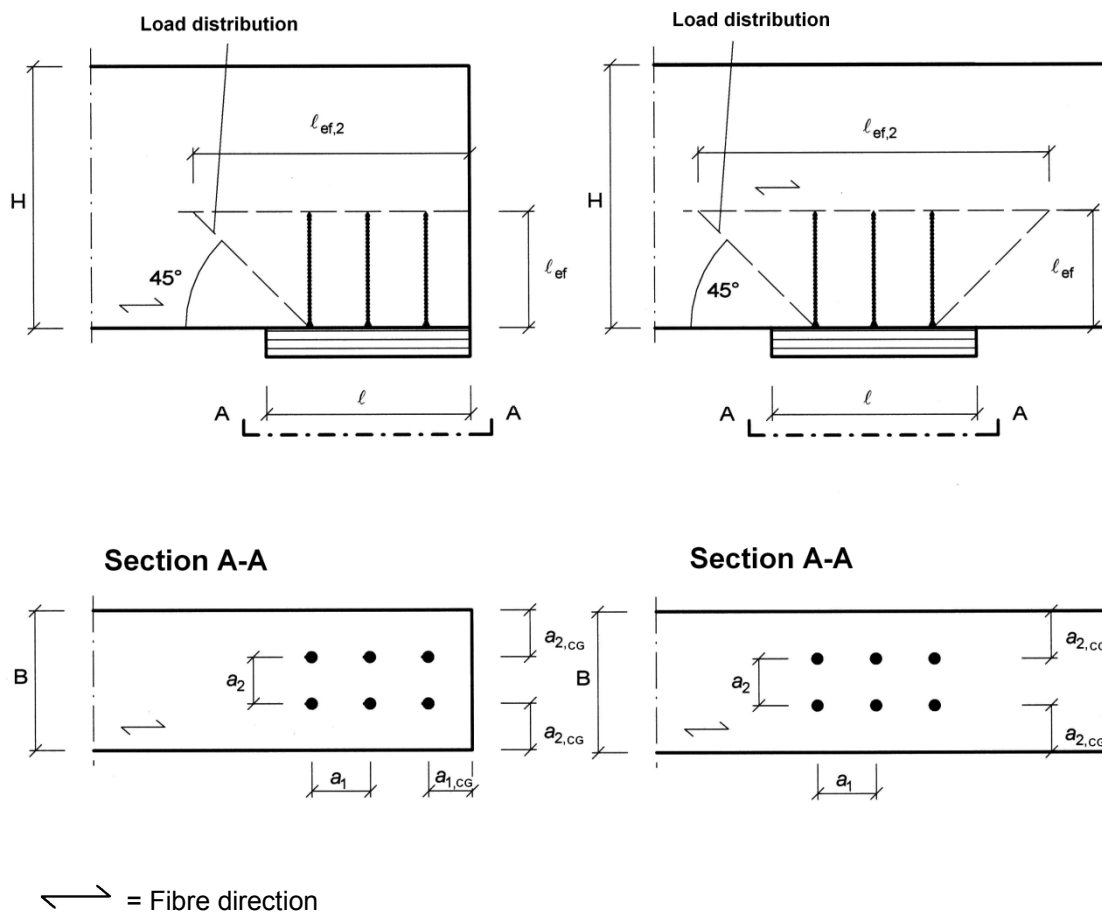

Figure A.3.1: Reinforced end support (left) and reinforced intermediate support (right)

SFS Self-tapping Screws WT	Annex 3
Compression reinforcement perpendicular to the grain	

ANNEX 4 Header-joist connections

The characteristic load-bearing capacity for header-joist connections with inclined screws ($\alpha = 45^\circ$) should be calculated as:

$$F_{90,Rk} = \frac{1.25 \cdot n_{ef} \cdot f_{ax,k} \cdot d \cdot l_{ef}}{\sqrt{2}} \quad (4.1)$$

and for header-joist connections with a crossed screw couple ($\alpha = 45^\circ$):

$$F_{90,Rk} = \frac{2 \cdot n_{ef} \cdot f_{ax,k} \cdot d \cdot l_{ef}}{\sqrt{2}} \quad (4.2)$$

Where:

- α angle α between screw axis and grain direction, $\alpha = 45^\circ$
- n_{ef} Effective number of inclined screws or crossed screw couples in the connection
 $n_{ef} = \max \{ n^{0.9}; 0.9 \cdot n \}$
- n number of inclined screws or crossed screw couples in the connection
- $f_{ax,k}$ Characteristic withdrawal parameter at an angle $\alpha = 90^\circ$ according to clause A.2.3.2
- d outer thread diameter of the screws [mm]
- l_{ef} penetration length of the threaded part of the screw near the screw head or near the screw tip in the timber member, whichever is the smaller [mm]

Equation (4.1) and (4.2) are only valid if the requirements according to Table A.4.1 are met.

Table A.4.1 Minimum spacing and distances of the screws and height of the joists

	SFS WT 6.5	SFS WT 8.2
Minimum end distance of the centre of gravity of the threaded part in the timber member $a_{1,CG}$	32 mm	40 mm
Minimum edge distance of the centre of gravity of the threaded part in the timber member $a_{2,CG}$	20 mm	24 mm
Minimum spacing a_2 perpendicular to a plane parallel to grain	25 mm	32 mm
Minimum spacing between crossing screws	10 mm	12 mm
Minimum height of the joists	76 mm	96 mm

SFS Self-tapping Screws WT	Annex 4
Header-joist connections	

WT-S-6,5 x L

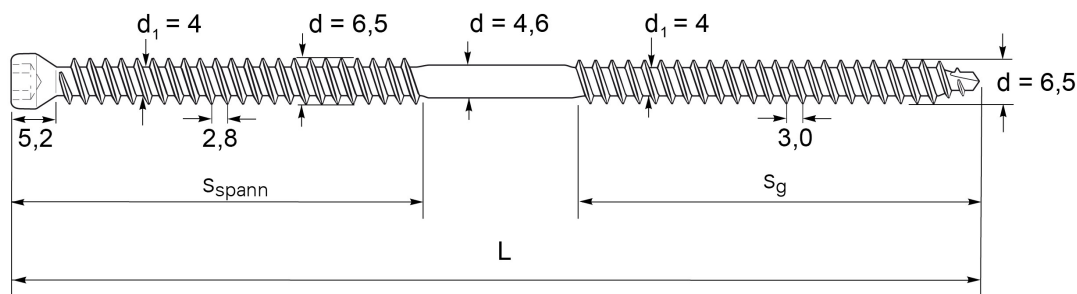
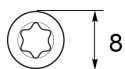

$65 \text{ mm} \leq L \leq 130 \text{ mm}$
 $28 \text{ mm} \leq s_{\text{spann}} \leq 55 \text{ mm}$
 $28 \text{ mm} \leq s_{\text{g}} \leq 55 \text{ mm}$

WT-T-6,5 x L

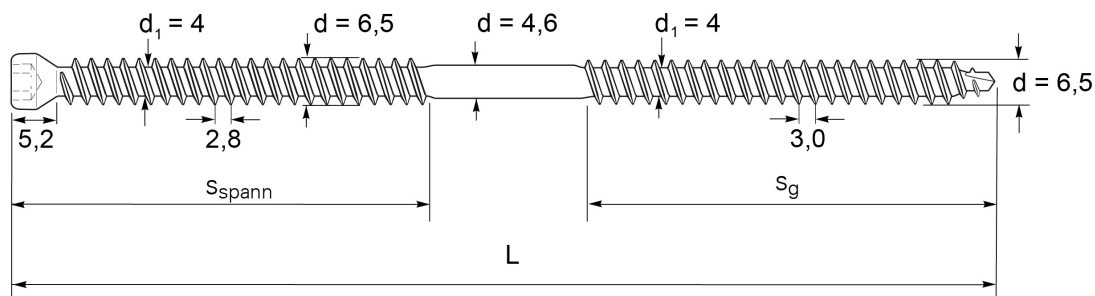

$65 \text{ mm} \leq L \leq 220 \text{ mm}$
 $28 \text{ mm} \leq s_{\text{spann}} \leq 95 \text{ mm}$
 $28 \text{ mm} \leq s_{\text{g}} \leq 95 \text{ mm}$

Alternative screw tip for screws WT-T-6,5

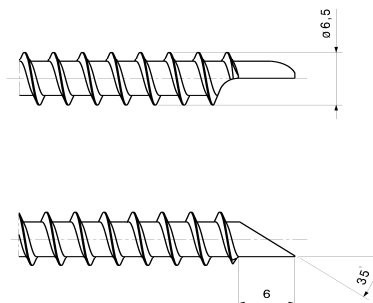

Tolerances	
Length	$\pm 5\%$
Diameter	$\pm 5\%$

SFS Self-tapping Screws WT

Self-tapping screws WT-S-6,5 and WT-T-6,5
Dimensions

Annex 5.1

WT-T-8,2 x L

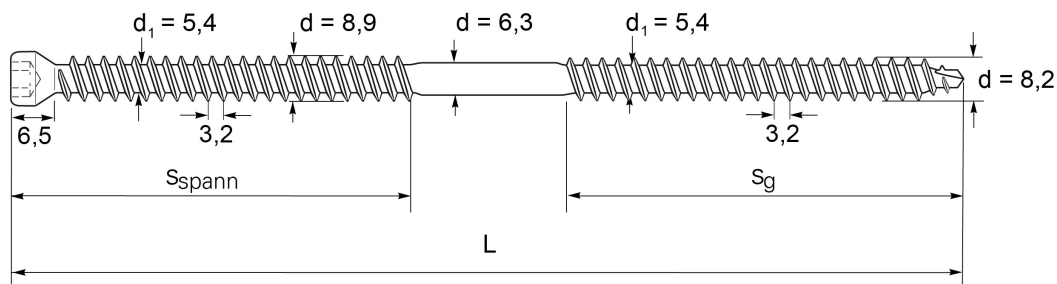
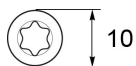

$160 \text{ mm} \leq L \leq 330 \text{ mm}$

$65 \text{ mm} \leq s_{\text{spann}} \leq 135 \text{ mm}$

$65 \text{ mm} \leq s_{\text{g}} \leq 135 \text{ mm}$

Tolerances	
Length	$\pm 5\%$
Diameter	$\pm 5\%$

Alternative screw tip for screws WT-T-8,2

