

Approval body for construction products  
and types of construction

Bautechnisches Prüfamt

An institution established by the Federal and  
Laender Governments



## European Technical Assessment

ETA-12/0084  
of 7 August 2019

English translation prepared by DIBt - Original version in German language

### General Part

Technical Assessment Body issuing the  
European Technical Assessment:

Deutsches Institut für Bautechnik

Trade name of the construction product

Injection system Hilti HIT-HY 200-R

Product family  
to which the construction product belongs

Bonded anchor for use in concrete

Manufacturer

Hilti Aktiengesellschaft  
9494 SCHAAN  
FÜRSTENTUM LIECHTENSTEIN

Manufacturing plant

Hilti Werke

This European Technical Assessment  
contains

40 pages including 3 annexes which form an integral part  
of this assessment

This European Technical Assessment is  
issued in accordance with Regulation (EU)  
No 305/2011, on the basis of

EAD 330499-01-0601

This version replaces

ETA-12/0084 issued on 28 July 2017

The European Technical Assessment is issued by the Technical Assessment Body in its official language. Translations of this European Technical Assessment in other languages shall fully correspond to the original issued document and shall be identified as such.

Communication of this European Technical Assessment, including transmission by electronic means, shall be in full. However, partial reproduction may only be made with the written consent of the issuing Technical Assessment Body. Any partial reproduction shall be identified as such.

This European Technical Assessment may be withdrawn by the issuing Technical Assessment Body, in particular pursuant to information by the Commission in accordance with Article 25(3) of Regulation (EU) No 305/2011.

## Specific Part

### 1 Technical description of the product

The Injection system Hilti HIT-HY 200-R is a bonded anchor consisting of a foil pack with injection mortar Hilti HIT-HY 200-R and a steel element according to Annex A.

The steel element is placed into a drilled hole filled with injection mortar and is anchored via the bond between metal part, injection mortar and concrete.

The product description is given in Annex A.

### 2 Specification of the intended use in accordance with the applicable European Assessment Document

The performances given in Section 3 are only valid if the anchor is used in compliance with the specifications and conditions given in Annex B.

The verifications and assessment methods on which this European Technical Assessment is based lead to the assumption of a working life of the anchor of at least 50 years. The indications given on the working life cannot be interpreted as a guarantee given by the producer, but are to be regarded only as a means for choosing the right products in relation to the expected economically reasonable working life of the works.

### 3 Performance of the product and references to the methods used for its assessment

#### 3.1 Mechanical resistance and stability (BWR 1)

Essential characteristic	Performance
Characteristic resistance for static and quasi-static tension load	See Annex C1 to C8
Characteristic resistance for static and quasi-static shear load	See Annex C2, C4, C6, C8
Displacements for static and quasi-static loads	See Annex C9 to C12
Characteristic resistance for seismic performance categories C1 and C2	See Annex C13 to C17
Durability	See Annex B2

#### 3.2 Hygiene, health and the environment (BWR 3)

Essential characteristic	Performance
Content, emission and/or release of dangerous substances	No performance assessed

### 4 Assessment and verification of constancy of performance (AVCP) system applied, with reference to its legal base

In accordance with the European Assessment Document EAD 330499-01-0601 the applicable European legal act is: [96/582/EC].

The system to be applied is: 1

**5 Technical details necessary for the implementation of the AVCP system, as provided for in the applicable European Assessment Document**

Technical details necessary for the implementation of the AVCP system are laid down in the control plan deposited at Deutsches Institut für Bautechnik.

Issued in Berlin on 7 August 2019 by Deutsches Institut für Bautechnik

BD Dipl.-Ing. Andreas Kummerow  
Head of Department

*beglaubigt:*  
Lange

### Installed condition

**Figure A1:**

Threaded rod, HAS-U-..., HIT-V-... and AM 8.8

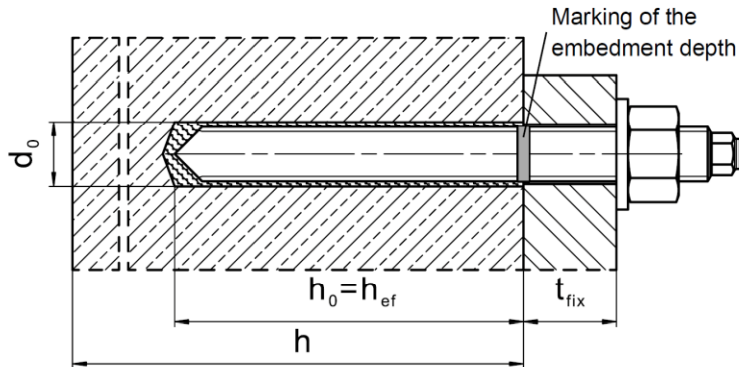

**Figure A2:**

Threaded rod, HAS-U-..., HIT-V-... and AM 8.8 with Hilti Filling Set

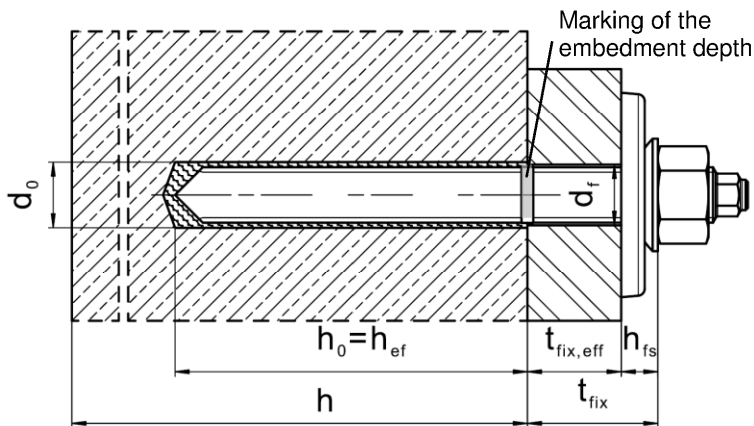

**Figure A3:**

Internally threaded sleeve HIS-(R)N

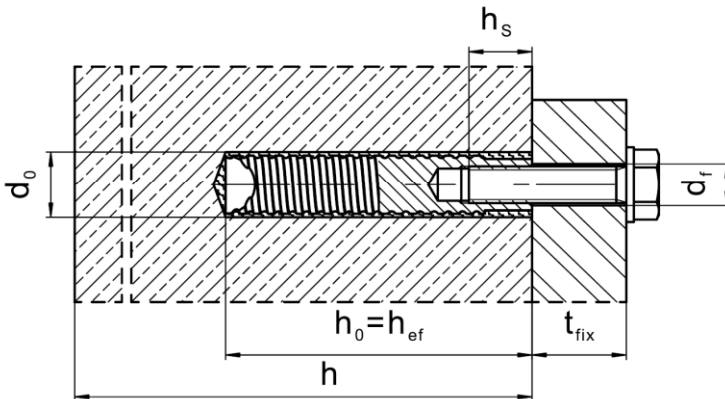

Injection System Hilti HIT-HY 200-R

Product description  
Installed condition

Annex A1

## Installed condition

**Figure A4:**  
**Reinforcing bar**

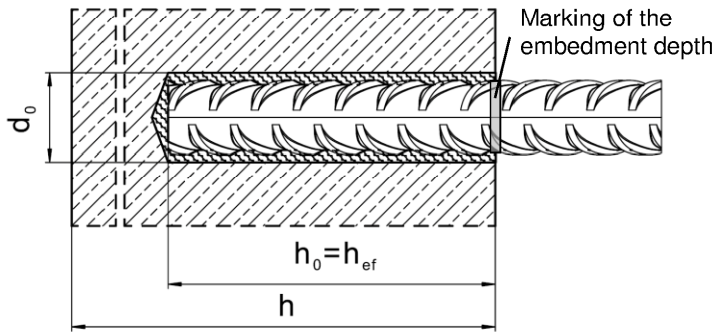

**Injection System Hilti HIT-HY 200-R**

**Product description**  
Installed condition

**Annex A2**

**Product description: Injection mortar and steel elements**

**Injection mortar Hilti HIT-HY 200-R:** hybrid system with aggregate  
330 ml and 500 ml

Marking:  
HILTI-HIT  
Production number and  
production line  
Expiry date mm/yyyy



Product name: "Hilti HIT-HY 200-R"

**Static mixer Hilti HIT-RE-M**



**Steel elements**

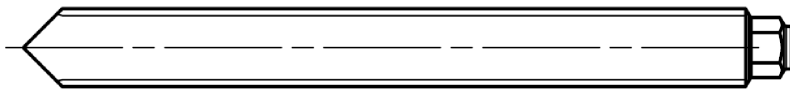

**HAS-U-....: M8 to M30**

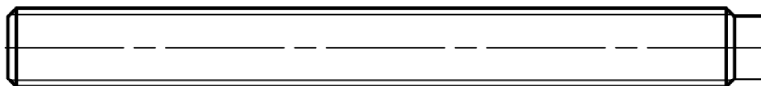
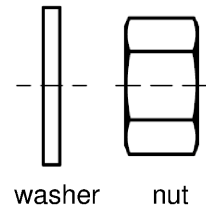

**HIT-V-....: M8 to M30**

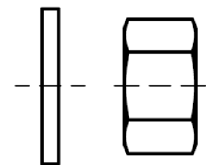
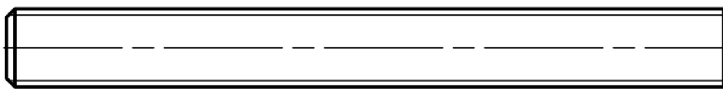
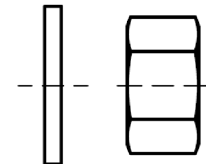

**Threaded rod: M8 to M30**

**Hilti AM 8.8 meter rod electroplated zinc coated: M8 to M30, 1m to 3m**

**Hilti AM HDG 8.8 meter rod hot dip galvanized: M8 to M30, 1m to 3m**

Commercial standard threaded rod:

- Materials and mechanical properties according to Table A1.
- Inspection certificate 3.1 according to EN 10204:2004. The document shall be stored.
- Marking of embedment depth.

**Injection System Hilti HIT-HY 200-R**

**Product description**  
Injection mortar / Static mixer / Steel elements

**Annex A3**

**Steel elements**

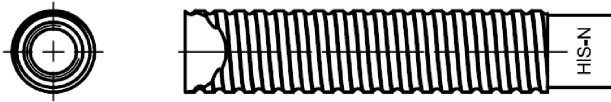

**Internally threaded sleeve: HIS-(R)N M8 to M20**

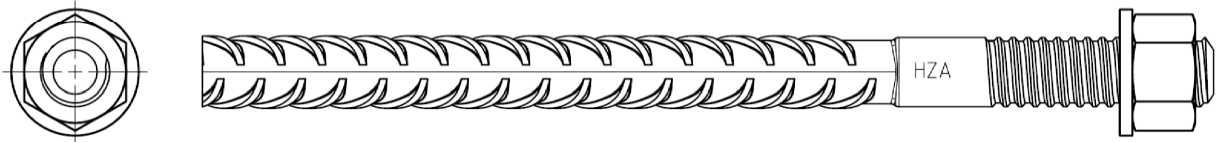

**Hilti Tension Anchor: HZA M12 to M27 and HZA-R M12 to M24**

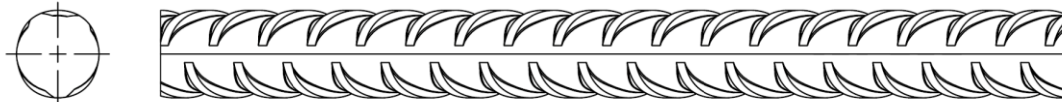

**Reinforcing bar (rebar):  $\phi$  8 to  $\phi$  32**

- Materials and mechanical properties according to Table A1
- Dimensions according to Annex B6

**Hilti Filling Set to fill the annular gap between anchor and fixture**

Sealing washer

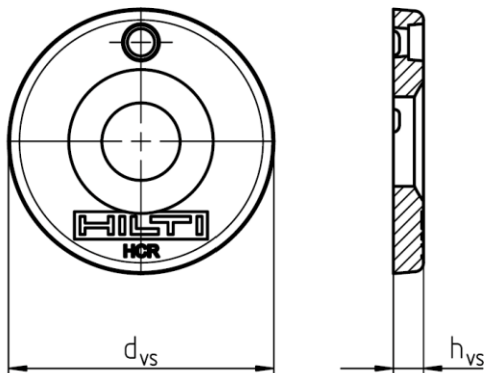

Spherical washer

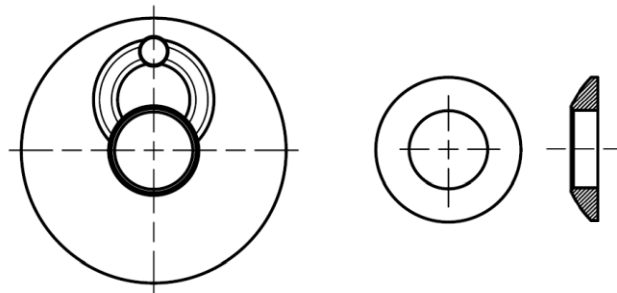

Hilti Filling Set		M16	M20	M24
Diameter of sealing washer	d <sub>vs</sub> [mm]	56	60	70
Thickness of sealing washer	h <sub>vs</sub> [mm]	6		
Thickness of Hilti Filling Set	h <sub>fs</sub> [mm]	11	13	15

**Injection System Hilti HIT-HY 200-R**

**Product description**  
Injection mortar / Static mixer / Steel elements

**Annex A4**



**Table A1: Materials**

Designation	Material
Reinforcing bars (rebars)	
Rebar: EN 1992-1-1: 2004 and AC:2010, Annex C	Bars and de-coiled rods class B or C with $f_{yk}$ and $k$ according to NDP or NCL of EN 1992-1-1/NA $f_{uk} = f_{tk} = k \cdot f_{yk}$
<b>Metal parts made of zinc coated steel</b>	
HAS-U-5.8(F), HIT-V-5.8(F), Threaded rod	Strength class 5.8, $f_{uk} = 500 \text{ N/mm}^2$ , $f_{yk} = 400 \text{ N/mm}^2$ , Elongation at fracture ( $l_0=5d$ ) > 8% ductile Electroplated zinc coated $\geq 5 \mu\text{m}$ , (F) hot dip galvanized $\geq 45 \mu\text{m}$
HAS-U-8.8(F), HIT-V-8.8(F), Threaded rod	Strength class 8.8, $f_{uk} = 800 \text{ N/mm}^2$ , $f_{yk} = 640 \text{ N/mm}^2$ , Elongation at fracture ( $l_0=5d$ ) > 12% ductile Electroplated zinc coated $\geq 5 \mu\text{m}$ , (F) hot dip galvanized $\geq 45 \mu\text{m}$
Hilti Meter rod AM 8.8 (HDG)	Strength class 8.8, $f_{uk} = 800 \text{ N/mm}^2$ , $f_{yk} = 640 \text{ N/mm}^2$ Elongation at fracture ( $l_0 = 5d$ ) > 12% ductile, Electroplated zinc coated $\geq 5 \mu\text{m}$ , (F) hot dip galvanized $\geq 45 \mu\text{m}$
Hilti tension anchor HZA	Round steel with threaded part: electroplated zinc coated $\geq 5 \mu\text{m}$ Rebar: Bars class B according to NDP or NCL of EN 1992-1-1/NA
Internally threaded sleeve HIS-N	Electroplated zinc coated $\geq 5 \mu\text{m}$
Washer	Electroplated zinc coated $\geq 5 \mu\text{m}$ , hot dip galvanized $\geq 45 \mu\text{m}$
Nut	Strength class of nut adapted to strength class of threaded rod Electroplated zinc coated $\geq 5 \mu\text{m}$ , (F) hot dip galvanized $\geq 45 \mu\text{m}$
Hilti Filling Set (F)	Filling washer: Electroplated zinc coated $\geq 5 \mu\text{m}$ , (F) hot dip galvanized $\geq 45 \mu\text{m}$ Spherical washer: Electroplated zinc coated $\geq 5 \mu\text{m}$ , (F) hot dip galvanized $\geq 45 \mu\text{m}$ Lock nut: Electroplated zinc coated $\geq 5 \mu\text{m}$ , (F) hot dip galvanized $\geq 45 \mu\text{m}$

**Injection System Hilti HIT-HY 200-R**

**Product description**  
Materials

**Annex A5**

**Table A1: continued**

<b>Metal parts made of stainless steel</b> <b>corrosion resistance classes III according EN 1993-1-4:2006+A1:2015-06</b>	
HAS-U-R, HIT-V-R	For $\leq$ M24: strength class 70, $f_{uk} = 700 \text{ N/mm}^2$ , $f_{yk} = 450 \text{ N/mm}^2$ ; For $>$ M24: strength class 50, $f_{uk} = 500 \text{ N/mm}^2$ , $f_{yk} = 210 \text{ N/mm}^2$ ; Elongation at fracture ( $l_0=5d$ ) $>$ 8% ductile
Threaded rod	For $\leq$ M24: strength class 70, $f_{uk} = 700 \text{ N/mm}^2$ , $f_{yk} = 450 \text{ N/mm}^2$ ; For $>$ M24: strength class 50, $f_{uk} = 500 \text{ N/mm}^2$ , $f_{yk} = 210 \text{ N/mm}^2$ ; Elongation at fracture ( $l_0=5d$ ) $>$ 8% ductile Stainless steel 1.4401, 1.4404, 1.4578, 1.4571, 1.4439, 1.4362 EN 10088-1:2014
Hilti tension anchor HZA-R	Round steel with threaded part: Stainless steel 1.4404, 1.4362, 1.4571 EN 10088-1:2014 Rebar: Bars class B according to NDP or NCL of EN 1992-1-1/NA
Internally threaded sleeve HIS-RN	Stainless steel 1.4401, 1.4571 EN 10088-1:2014
Washer	Stainless steel 1.4401, 1.4404, 1.4578, 1.4571, 1.4439, 1.4362 EN 10088-1:2014
Nut	For $\leq$ M24: strength class 70, $f_{uk} = 700 \text{ N/mm}^2$ , $f_{yk} = 450 \text{ N/mm}^2$ ; For $>$ M24: strength class 50, $f_{uk} = 500 \text{ N/mm}^2$ , $f_{yk} = 210 \text{ N/mm}^2$ ; Stainless steel 1.4401, 1.4404, 1.4578, 1.4571, 1.4439, 1.4362 EN 10088-1:2014
<b>Metal parts made of high corrosion resistant steel</b> <b>corrosion resistance classes V according EN 1993-1-4:2006+A1:2015-06</b>	
HAS-U-HCR, HIT-V-HCR	For $\leq$ M20: $f_{uk} = 800 \text{ N/mm}^2$ , $f_{yk} = 640 \text{ N/mm}^2$ , For $>$ M20: $f_{uk} = 700 \text{ N/mm}^2$ , $f_{yk} = 400 \text{ N/mm}^2$ , Elongation at fracture ( $l_0=5d$ ) $>$ 8% ductile
Threaded rod	For $\leq$ M20: $f_{uk} = 800 \text{ N/mm}^2$ , $f_{yk} = 640 \text{ N/mm}^2$ , For $>$ M20: $f_{uk} = 700 \text{ N/mm}^2$ , $f_{yk} = 400 \text{ N/mm}^2$ , Elongation at fracture ( $l_0=5d$ ) $>$ 8% ductile High corrosion resistant steel 1.4529, 1.4565 EN 10088-1:2014
Washer	High corrosion resistant steel 1.4529, 1.4565 EN 10088-1:2014
Nut	For $\leq$ M20: $f_{uk} = 800 \text{ N/mm}^2$ , $f_{yk} = 640 \text{ N/mm}^2$ , For $>$ M20: $f_{uk} = 700 \text{ N/mm}^2$ , $f_{yk} = 400 \text{ N/mm}^2$ , High corrosion resistant steel 1.4529, 1.4565 EN 10088-1:2014

**Injection System Hilti HIT-HY 200-R**

**Product description**  
Materials

**Annex A6**

## Specifications of intended use

### Anchorage subject to:

- Static and quasi static loading.
- Seismic performance category C1 and C2 (see Table B1).







### Base material:

- Compacted reinforced or unreinforced normal weight concrete without fibres according to EN 206-1:2013+A1:2016.
- Strength classes C20/25 to C50/60 according to EN 206-1:2013+A1:2016.
- Cracked and uncracked concrete.

### Temperature in the base material:

- **at installation**  
-10 °C to +40 °C for the standard variation of temperature after installation
- **in-service**  
Temperature range I: -40 °C to +40 °C  
(max. long term temperature +24 °C and max. short term temperature +40 °C)  
Temperature range II: -40 °C to +80 °C  
(max. long term temperature +50 °C and max. short term temperature +80 °C)  
Temperature range III: -40 °C to +120 °C  
(max. long term temperature +72 °C and max. short term temperature +120 °C)

**Table B1: Specifications of intended use**

Elements	HIT-HY 200-R with ...			
	HAS-U-..., HIT-V-..., AM 8.8 	Rebar 	HZA(-R) 	HIS-(R)N 
Hammer drilling with hollow drill bit TE-CD or TE-YD 	✓	✓	✓	✓
Hammer drilling 	✓	✓	✓	✓
Diamond drilling with roughening tool TE-YRT 	✓	✓	✓	✓
Static and quasi static loading in cracked and uncracked concrete	M8 to M30	φ 8 to φ 32	M12 to M27	M8 to M20
Seismic performance category C1	M10 to M30	φ 10 to φ 32	M12 to M27	-
Seismic performance category C2	M16 to M24, HAS-U 8.8, HIT-V 8.8, AM 8.8, HAS-U-F 8.8, HIT-V-F 8.8, AM HDG 8.8 Commercial standard rod (electroplated zinc coated only)	-	-	-

Injection System Hilti HIT-HY 200-R

Intended Use  
Specifications

Annex B1

**Use conditions (Environmental conditions):**

- Structures subject to dry internal conditions (all materials).
- For all other conditions according EN 1993-1-4:2006+A1:2015-06 corresponding to corrosion resistance classes Table A1 Annex A6. (stainless steels)

**Design:**

- Anchorages are designed under the responsibility of an engineer experienced in anchorages and concrete work.
- Verifiable calculation notes and drawings are prepared taking account of the loads to be anchored. The position of the anchor is indicated on the design drawings (e. g. position of the anchor relative to reinforcement or to supports, etc.).
- The anchorages are designed in accordance with:  
EN 1992-4:2018 and EOTA Technical Report TR 055.

**Installation:**

- Use category: dry or wet concrete (not in flooded holes) for all drilling techniques
- Drilling technique:
  - Hammer drilling,
  - Hammer drilling with Hilti hollow drill bit TE-CD, TE-YD,
  - Diamond coring with roughening with Hilti roughening tool TE-YRT.
- Installation direction D3: downward, horizontal and upward (e.g. overhead) installation admissible for all elements.
- Anchor installation carried out by appropriately qualified personnel and under the supervision of the person responsible for technical matters of the site.

electronic copy of the eta by dibt: eta-12/0084

<b>Injection System Hilti HIT-HY 200-R</b>	<b>Annex B2</b>
<b>Intended Use Specifications</b>	

**Table B2: Installation parameters of threaded rod, HAS-U-..., HIT-V-... and AM 8.8**

Threaded rod, HAS-U- ..., HIT-V-..., AM 8.8	M8	M10	M12	M16	M20	M24	M27	M30
Diameter of element d [mm]	8	10	12	16	20	24	27	30
Nominal diameter of drill bit d <sub>0</sub> [mm]	10	12	14	18	22	28	30	35
Effective embedment depth and drill hole depth h <sub>ef</sub> = h <sub>0</sub> [mm]	60 to 160	60 to 200	70 to 240	80 to 320	90 to 400	96 to 480	108 to 540	120 to 600
Maximum diameter of clearance hole in the fixture d <sub>f</sub> [mm]	9	12	14	18	22	26	30	33
Thickness of Hilti Filling Set h <sub>fs</sub> [mm]	-	-	-	11	13	15	-	-
Effective fixture thickness with Hilti Filling Set t <sub>fix,eff</sub> [mm]	$t_{fix,eff} = t_{fix} - h_{fs}$							
Minimum thickness of concrete member h <sub>min</sub> [mm]	$h_{ef} + 30$ ≥ 100 mm			$h_{ef} + 2 \cdot d_0$				
Maximum torque moment T <sub>max</sub> [Nm]	10	20	40	80	150	200	270	300
Minimum spacing s <sub>min</sub> [mm]	40	50	60	75	90	115	120	140
Minimum edge distance c <sub>min</sub> [mm]	40	45	45	50	55	60	75	80

**HAS-U-...**

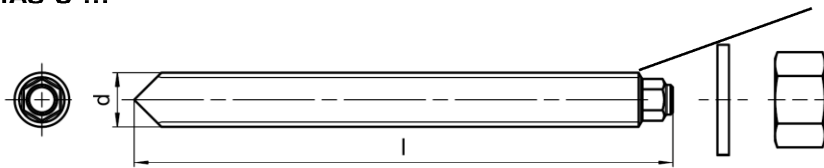

**Marking:**

Steel grade number and length identification letter: e.g. 8L

**HIT-V-...**



**Marking:**

5.8 - l = HIT-V-5.8 M...x l  
 5.8F - l = HIT-V-5.8F M...x l  
 8.8 - l = HIT-V-8.8 M...x l  
 8.8F - l = HIT-V-8.8F M...x l  
 R - l = HIT-V-R M...x l  
 HCR - l = HIT-V-HCR M...x l

**Hilti meter rod AM (HDG) 8.8**

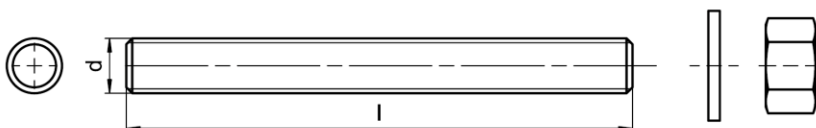

**Injection System Hilti HIT-HY 200-R**

**Intended Use**

Installation parameters of threaded rod, HAS-U-..., HIT-V-... and AM 8.8

**Annex B3**

**Table B3: Installation parameters of internally threaded sleeve HIS-(R)N**

Internally threaded sleeve HIS-(R)N...		M8	M10	M12	M16	M20
Outer diameter of sleeve	d [mm]	12,5	16,5	20,5	25,4	27,6
Nominal diameter of drill bit	d <sub>0</sub> [mm]	14	18	22	28	32
Effective embedment depth and drill hole depth	h <sub>ef</sub> = h <sub>0</sub> [mm]	90	110	125	170	205
Maximum diameter of clearance hole in the fixture	d <sub>f</sub> [mm]	9	12	14	18	22
Minimum thickness of concrete member	h <sub>min</sub> [mm]	120	150	170	230	270
Maximum torque moment	T <sub>max</sub> [Nm]	10	20	40	80	150
Thread engagement length min-max	h <sub>s</sub> [mm]	8-20	10-25	12-30	16-40	20-50
Minimum spacing	s <sub>min</sub> [mm]	60	75	90	115	130
Minimum edge distance	c <sub>min</sub> [mm]	40	45	55	65	90

**Internally threaded sleeve HIS-(R)N...**

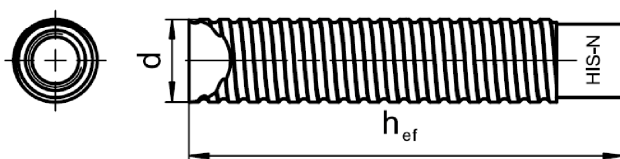

**Marking:**

Identifying mark - HILTI and  
embossing "HIS-N" (for C-steel)  
embossing "HIS-RN" (for stainless steel)

**Injection System Hilti HIT-HY 200-R**

**Intended Use**

Installation parameters of internally threaded sleeve HIS-(R)N

**Annex B4**

**Table B4: Installation parameters of Hilti tension anchor HZA-R**

Hilti tension anchor HZA-R ...			M12	M16	M20	M24
Rebar diameter	$\phi$	[mm]	12	16	20	25
Nominal embedment depth and drill hole depth	$h_{nom} = h_0$	[mm]	170 to 240	180 to 320	190 to 400	200 to 500
Effective embedment depth ( $h_{ef} = h_{nom} - l_e$ )	$h_{ef}$	[mm]	$h_{nom} - 100$			
Length of smooth shaft	$l_e$	[mm]	100			
Nominal diameter of drill bit	$d_0$	[mm]	16	20	25	32
Maximum diameter of clearance hole in the fixture <sup>1)</sup>	$d_f$	[mm]	14	18	22	26
Maximum torque moment	$T_{max}$	[Nm]	40	80	150	200
Minimum thickness of concrete member	$h_{min}$	[mm]	$h_{nom} + 2 \cdot d_0$			
Minimum spacing	$s_{min}$	[mm]	65	80	100	130
Minimum edge distance	$c_{min}$	[mm]	45	50	55	60

**Table B5: Installation parameters of Hilti tension anchor HZA**

Hilti tension anchor HZA...			M12	M16	M20	M24	M27
Rebar diameter	$\phi$	[mm]	12	16	20	25	28
Nominal embedment depth and drill hole depth	$h_{nom} = h_0$	[mm]	90 to 240	100 to 320	110 to 400	120 to 500	140 to 560
Effective embedment depth ( $h_{ef} = h_{nom} - l_e$ )	$h_{ef}$	[mm]	$h_{nom} - 20$				
Length of smooth shaft	$l_e$	[mm]	20				
Nominal diameter of drill bit	$d_0$	[mm]	16	20	25	32	35
Maximum diameter of clearance hole in the fixture <sup>1)</sup>	$d_f$	[mm]	14	18	22	26	30
Maximum torque moment	$T_{max}$	[Nm]	40	80	150	200	270
Minimum thickness of concrete member	$h_{min}$	[mm]	$h_{nom} + 2 \cdot d_0$				
Minimum spacing	$s_{min}$	[mm]	65	80	100	130	140
Minimum edge distance	$c_{min}$	[mm]	45	50	55	60	75

**Marking:**  
embossing "HZA(-R)" M .. / t<sub>fix</sub>

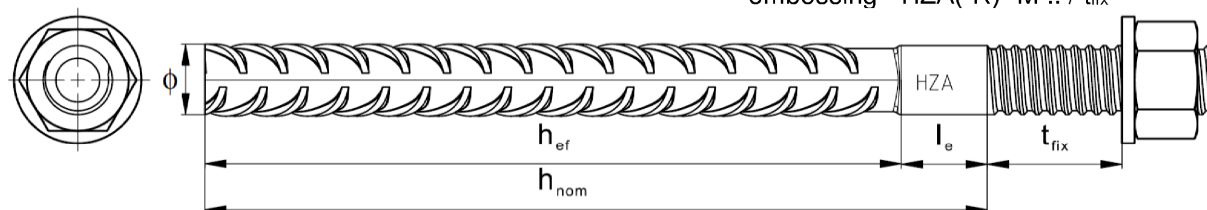

**Injection System Hilti HIT-HY 200-R**

**Intended Use**

Installation parameters of Hilti tension anchor HZA(-R)

**Annex B5**

**Table B6: Installation parameters of reinforcing bar**

Reinforcing bar (rebar)	$\phi$ 8	$\phi$ 10	$\phi$ 12	$\phi$ 14	$\phi$ 16	$\phi$ 20	$\phi$ 25	$\phi$ 26	$\phi$ 28	$\phi$ 30	$\phi$ 32
Diameter $\phi$ [mm]	8	10	12	14	16	20	25	26	28	30	32
Effective embedment depth and drill hole depth $h_{ef} = h_o$ [mm]	60 to 160	60 to 200	70 to 240	75 to 280	80 to 320	90 to 400	100 to 500	104 to 520	112 to 560	120 to 600	128 to 640
Nominal diameter of drill bit $d_o$ [mm]	10 / 12 <sup>1)</sup>	12 / 14 <sup>1)</sup>	14 <sup>1)</sup> / 16 <sup>1)</sup>	18	20	25	32	32	35	37	40
Minimum thickness of concrete member $h_{min}$ [mm]	$h_{ef} + 30$ $\geq 100$ mm			$h_{ef} + 2 \cdot d_o$							
Minimum spacing $s_{min}$ [mm]	40	50	60	70	80	100	125	130	140	150	160
Minimum edge distance $c_{min}$ [mm]	40	45	45	50	50	65	70	75	75	80	80

<sup>1)</sup> Each of the two given values can be used.

**Reinforcing bar**

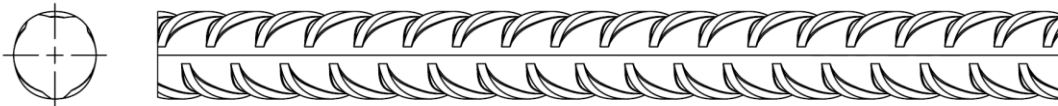

For rebar bolt

- Minimum value of related rib area  $f_{R,min}$  according to EN 1992-1-1:2004+AC:2010
- Rib height of the bar  $h_{rib}$  shall be in the range  $0,05 \cdot \phi \leq h_{rib} \leq 0,07 \cdot \phi$   
( $\phi$ : Nominal diameter of the bar;  $h_{rib}$ : Rib height of the bar)

**Injection System Hilti HIT-HY 200-R**

**Intended Use**  
Installation parameters of reinforcing bar (rebar)

**Annex B6**



**Table B7: Maximum working time and minimum curing time Hilti-HY 200-R**

Temperature in the base material T	Maximum working time $t_{work}$	Minimum curing time $t_{cure}$
-10 °C to -5 °C	3 hours	20 hours
> -5 °C to 0 °C	2 hours	8 hours
> 0 °C to 5 °C	1 hour	4 hours
> 5 °C to 10 °C	40 min	2,5 hours
> 10 °C to 20 °C	15 min	1,5 hours
> 20 °C to 30 °C	9 min	1 hour
> 30 °C to 40 °C	6 min	1 hour











electronic copy of the eta by dibt: eta-12/0084

**Injection System Hilti HIT-HY 200-R**

**Intended Use**  
Maximum working time and minimum curing time

**Annex B7**

**Table B8: Parameters of cleaning and setting tools**

Elements				Drill and clean					Installation
Threaded rod, HAS-U-..., HIT-V-..., AM 8.8	HIS-(R)N	Rebar	HZA(-R)	Hammer drilling		Diamond coring		Brush	Piston plug
				Hollow drill bit		Roughening tool			
									
size	size	size	size	d <sub>0</sub> [mm]	d <sub>0</sub> [mm]	d <sub>0</sub> [mm]	d <sub>0</sub> [mm]	HIT-RB	HIT-SZ
M8	-	φ8	-	10	-	-	-	10	-
M10	-	φ8 / φ10	-	12	12 <sup>1)</sup>	-	-	12	12
M12	M8	φ10 / φ12	-	14	14 <sup>1)</sup>	-	-	14	14
-	-	φ12	M12	16	16	-	-	16	16
M16	M10	φ14	-	18	18	18	18	18	18
-	-	φ16	M16	20	20	20	20	20	20
M20	M12	-	-	22	22	22	22	22	22
-	-	φ20	M20	25	25	25	25	25	25
M24	M16	-	-	28	28	28	28	28	28
M27	-	-	-	30	-	-	-	30	30
-	M20	φ25 / φ26	M24	32	32	32	32	32	32
M30	-	φ28	M27	35	35	35	35	35	35
-	-	φ30	-	37	-	-	-	37	37
-	-	φ32	-	40	-	-	-	40	40

<sup>1)</sup> To be used in combination with Hilti vacuum cleaner with suction volume  $\geq 61$  l/s (VC 20/40 -Y in corded mode only).

### Cleaning alternatives

#### Manual Cleaning (MC):

Hilti hand pump for blowing out drill holes with diameters  $d_0 \leq 20$  mm and drill hole depths  $h_0 \leq 10 \cdot d$ .



#### Compressed air cleaning (CAC):

Air nozzle with an orifice opening of minimum 3,5 mm in diameter.



#### Automatic Cleaning (AC):

Cleaning is performed during drilling with Hilti TE-CD and TE-YD drilling system including vacuum cleaner.





**Injection System Hilti HIT-HY 200-R**

#### Intended Use

Parameters of cleaning and setting tools  
Cleaning alternatives

**Annex B8**

**Table B9: Parameters for use of the Hilti Roughening tool TE-YRT**

Associated components			
Diamond coring		Roughening tool TE-YRT	Wear gauge RTG...
			
d <sub>0</sub> [mm]		d <sub>0</sub> [mm]	size
nominal	measured		
18	17,9 to 18,2	18	18
20	19,9 to 20,2	20	20
22	21,9 to 22,2	22	22
25	24,9 to 25,2	25	25
28	27,9 to 28,2	28	28
30	29,9 to 30,2	30	30
32	31,9 to 32,2	32	32
35	34,9 to 35,2	35	35

**Table B10: Installation parameters for use of the Hilti Roughening tool TE-YRT**

	Roughening time t <sub>roughen</sub>	Minimum blowing time t <sub>blowing</sub>
h <sub>ef</sub> [mm]	t <sub>roughen</sub> [sec] = h <sub>ef</sub> [mm] / 10	t <sub>blowing</sub> [sec] = t <sub>roughen</sub> [sec] + 20
0 to 100	10	30
101 to 200	20	40
201 to 300	30	50
301 to 400	40	60
401 to 500	50	70
501 to 600	60	80

**Hilti roughening tool TE-YRT and wear gauge RTG**

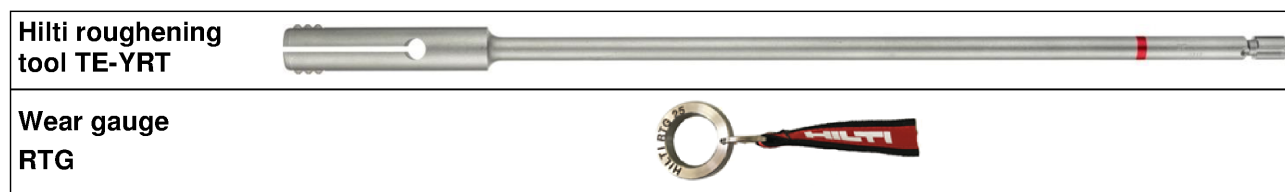

Injection System Hilti HIT-HY 200-R

Intended Use  
Parameters for use of the Hilti Roughening tool TE-YRT

**Annex B9**

## Installation instruction

### Hole drilling

#### a) Hammer drilling

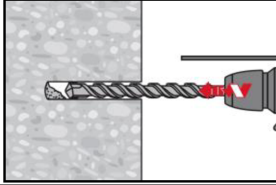

Drill hole to the required embedment depth with a hammer drill set in rotation-hammer mode using an appropriately sized carbide drill bit.

#### b) Hammer drilling with Hilti hollow drill bit

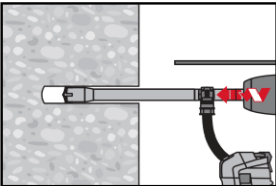

Drill hole to the required embedment depth with an appropriately sized Hilti TE-CD or TE-YD hollow drill bit attached to Hilti vacuum cleaner VC 20/40 (-Y) (suction volume  $\geq 57$  l/s) with automatic cleaning of the filter activated. This drilling system removes the dust and cleans the drill hole during drilling when used in accordance with the user's manual. When using TE-CD size 12 and 14 refer to Table B8. After drilling is completed, proceed to the "injection preparation" step in the installation instruction.

#### c) Diamond coring with roughening with Hilti roughening tool TE-YRT:

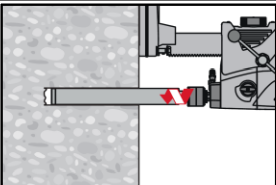

Diamond coring is permissible when suitable diamond core drilling machines and the corresponding core bits are used.  
For the use in combination with Hilti roughening tool TE-YRT see parameters in Table B10.

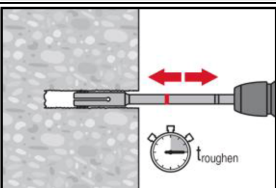

Before roughening water needs to be removed from the drill hole.  
Check usability of the roughening tool with the wear gauge RTG.  
Roughen the drill hole over the whole length to the required  $h_{ef}$ .

#### Drill hole cleaning

Just before setting an anchor, the drill hole must be free of dust and debris.  
Inadequate hole cleaning = poor load values.

#### Manual Cleaning (MC)

Uncracked concrete only.  
For drill hole diameters  $d_0 \leq 20$  mm and drill hole depths  $h_0 \leq 10 \cdot d$ .

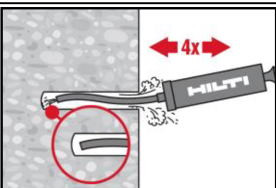

The Hilti hand pump may be used for blowing out drill holes up to diameters  $d_0 \leq 20$  mm and embedment depths up to  $h_{ef} \leq 10 \cdot d$ .  
Blow out at least 4 times from the back of the drill hole until return air stream is free of noticeable dust.

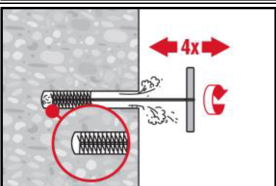

Brush 4 times with the specified brush (see Table B8) by inserting the steel brush Hilti HIT-RB to the back of the hole (if needed with extension) in a twisting motion and removing it. The brush must produce natural resistance as it enters the drill hole (brush  $\varnothing \geq$  drill hole  $\varnothing$ ) - if not the brush is too small and must be replaced with the proper brush diameter.

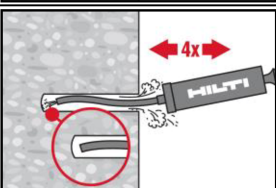

Blow out again with the Hilti hand pump at least 4 times until return air stream is free of noticeable dust.

### Injection System Hilti HIT-HY 200-R

**Intended Use**  
Installation instructions

**Annex B10**

**Compressed air cleaning (CAC) for all drill hole diameters  $d_0$  and all drill hole depths  $h_0$**

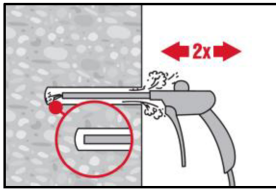

Blow 2 times from the back of the hole (if needed with nozzle extension) over the hole length with oil-free compressed air (min. 6 bar at 6 m<sup>3</sup>/h) until return air stream is free of noticeable dust.  
For drill hole diameters  $\geq 32$  mm the compressor has to supply a minimum air flow of 140 m<sup>3</sup>/h.

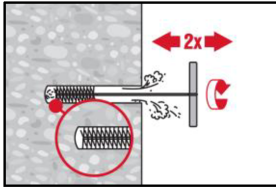

Brush 2 times with the specified brush (see Table B8) by inserting the steel brush Hilti HIT-RB to the back of the hole (if needed with extension) in a twisting motion and removing it. The brush must produce natural resistance as it enters the drill hole (brush  $\varnothing \geq$  drill hole  $\varnothing$ ) - if not the brush is too small and must be replaced with the proper brush diameter.

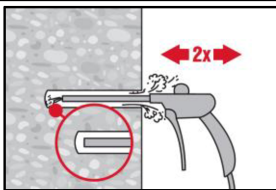

Blow again with compressed air 2 times until return air stream is free of noticeable dust.

**Cleaning of diamond cored holes with roughening with Hilti roughening tool TE-YRT.**

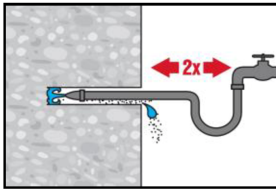

Flush 2 times by inserting a water hose (water-line pressure) to the back of the hole until water runs clear.

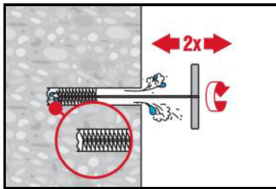

Brush 2 times with the specified brush (see Table B8) by inserting the steel brush Hilti HIT-RB to the back of the hole (if needed with extension) in a twisting motion and removing it. The brush must produce natural resistance as it enters the drill hole (brush  $\varnothing \geq$  drill hole  $\varnothing$ ) - if not the brush is too small and must be replaced with the proper brush diameter.

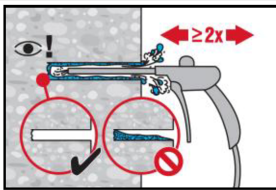

Blow 2 times from the back of the hole (if needed with nozzle extension) over the whole length with oil-free compressed air (min. 6 bar at 6 m<sup>3</sup>/h) until return air stream is free of noticeable dust and water. Remove all water from the drillhole until drillhole is completely dried before mortar injection. For drill hole diameters  $\geq 32$  mm the compressor has to supply a minimum air flow of 140 m<sup>3</sup>/h.

**Injection System Hilti HIT-HY 200-R**

**Intended Use**  
Installation instructions

**Annex B11**

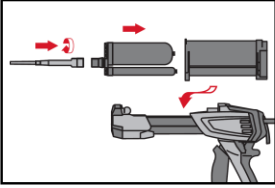
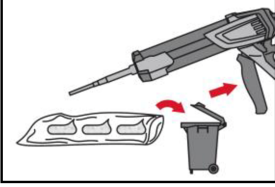
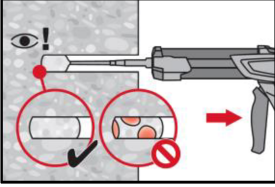
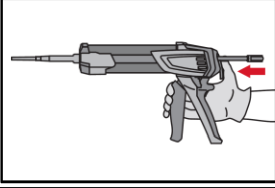
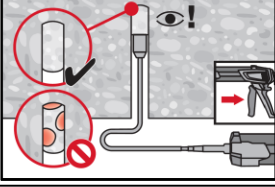
<p><b>Injection preparation</b></p>							
	<p>Tightly attach Hilti mixing nozzle HIT-RE-M to foil pack manifold. Do not modify the mixing nozzle. Observe the instruction for use of the dispenser. Check foil pack holder for proper function. Insert foil pack into foil pack holder and put holder into dispenser.</p>						
	<p>The foil pack opens automatically as dispensing is initiated. Depending on the size of the foil pack, an initial amount of adhesive has to be discarded. Discarded quantities are</p> <table border="0"> <tr> <td>2 strokes</td> <td>for 330 ml foil pack,</td> </tr> <tr> <td>3 strokes</td> <td>for 500 ml foil pack,</td> </tr> <tr> <td>4 strokes</td> <td>for 500 ml foil pack ≤ 5 °C.</td> </tr> </table>	2 strokes	for 330 ml foil pack,	3 strokes	for 500 ml foil pack,	4 strokes	for 500 ml foil pack ≤ 5 °C.
2 strokes	for 330 ml foil pack,						
3 strokes	for 500 ml foil pack,						
4 strokes	for 500 ml foil pack ≤ 5 °C.						
<p><b>Inject adhesive</b> from the back of the drill hole without forming air voids.</p>							
	<p>Inject the adhesive starting at the back of the hole, slowly withdrawing the mixer with each trigger pull. Fill approximately 2/3 of the drill hole to ensure that the annular gap between the anchor and the concrete is completely filled with adhesive along the embedment length. In water saturated concrete it is required to set the fastener immediately after cleaning the drillhole.</p>						
	<p>After injection is completed, depressurize the dispenser by pressing the release trigger. This will prevent further adhesive discharge from the mixer.</p>						
	<p>Overhead installation and/or installation with embedment depth <math>h_{ef} &gt; 250\text{mm}</math>. For overhead installation the injection is only possible with the aid of extensions and piston plugs. Assemble HIT-RE-M mixer, extension(s) and appropriately sized piston plug (see Table B8). Insert piston plug to back of the hole and inject adhesive. During injection the piston plug will be naturally extruded out of the drill hole by the adhesive pressure.</p>						
<p><b>Injection System Hilti HIT-HY 200-R</b></p>							
<p><b>Intended Use</b> Installation instructions</p>	<p><b>Annex B12</b></p>						

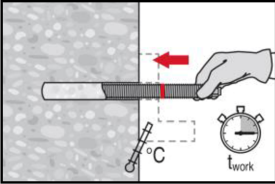
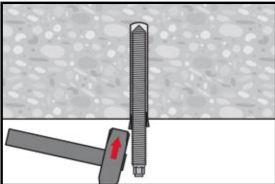
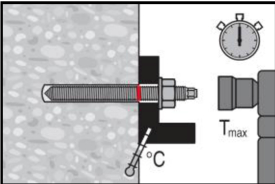
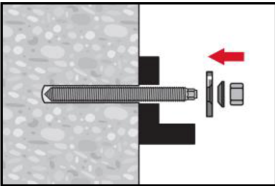
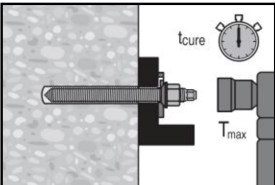
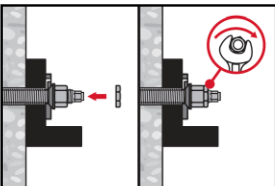
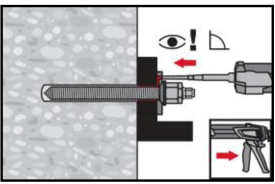
<p><b>Setting the element</b></p>  <p>Before use, verify that the element is dry and free of oil and other contaminants. Mark and set element to the required embedment depth before working time <math>t_{work}</math> (see Table B7) has elapsed.</p>	
 <p>For overhead installation use piston plugs and fix embedded parts with e.g. wedges (Hilti HIT-OHW).</p>	
 <p>Loading the anchor: After required curing time <math>t_{cure}</math> (see Table B7) the anchor can be loaded. The applied installation torque shall not exceed the values <math>T_{max}</math> given in Table B2 to Table B5.</p>	
<p><b>Installation of Hilti Filling Set</b></p>	
 <p>Use Hilti Filling Set with standard nut. Observe the correct orientation of filling washer and spherical washer.</p>	
 <p>The applied installation torque shall not exceed the values <math>T_{max}</math> given in Table B2 to Table B5.</p>	
 <p>Optional: Installation of lock nut. Tighten with a <math>\frac{1}{4}</math> to <math>\frac{1}{2}</math> turn. (Not for size M24.)</p>	
 <p>Fill the annular gap between the anchor rod and fixture with 1-3 strokes of Hilti injection mortar HIT-HY 200 R. Follow the installation instructions supplied with the HIT-HY 200 R foil pack. After required curing time <math>t_{cure}</math> the anchor can be loaded.</p>	
<p><b>Injection System Hilti HIT-HY 200-R</b></p>	
<p><b>Intended Use</b> Installation instructions</p>	<p><b>Annex B13</b></p>

**Table C1: Essential characteristics for threaded rod, HAS-U-..., HIT-V-... and AM 8.8 under tension load in concrete**

Threaded rod, HAS-U-..., HIT-V-... and AM 8.8		M8	M10	M12	M16	M20	M24	M27	M30
<b>Installation safety factor</b>									
Hammer drilling	$\gamma_{inst}$	[-]		1,0					
Hammer drilling with Hilti hollow drill bit TE-CD or TE-YD	$\gamma_{inst}$	[-]		-	1,0				
Diamond coring with roughening with Hilti roughening tool TE-YRT	$\gamma_{inst}$	[-]		-			1,0		
<b>Steel failure</b>									
Characteristic resistance	$N_{Rk,s}$	[kN]		$A_s \cdot f_{uk}$					
Partial factor grade 5.8	$\gamma_{Ms,N^1}$	[-]		1,5					
Partial factor grade 8.8	$\gamma_{Ms,N^1}$	[-]		1,5					
Partial factor HIT-V-R	$\gamma_{Ms,N^1}$	[-]		1,86			2,86		
Partial factor HIT-V-HCR	$\gamma_{Ms,N^1}$	[-]		1,5			2,1		
<b>Combined pullout and concrete cone failure</b>									
Characteristic bond resistance in uncracked concrete C20/25									
Temperature range I: 40 °C / 24 °C	$\tau_{Rk,ucr}$	[N/mm <sup>2</sup> ]		18					
Temperature range II: 80 °C / 50 °C	$\tau_{Rk,ucr}$	[N/mm <sup>2</sup> ]		15					
Temperature range III: 120 °C / 72 °C	$\tau_{Rk,ucr}$	[N/mm <sup>2</sup> ]		13					
Characteristic bond resistance in cracked concrete C20/25									
Temperature range I: 40 °C / 24 °C	$\tau_{Rk,cr}$	[N/mm <sup>2</sup> ]		7,5	8,5		9,0		
Temperature range II: 80 °C / 50 °C	$\tau_{Rk,cr}$	[N/mm <sup>2</sup> ]		6,0	7,0		7,5		
Temperature range III: 120 °C / 72 °C	$\tau_{Rk,cr}$	[N/mm <sup>2</sup> ]		5,5	6,0		6,5		
<b>Influence factors <math>\psi</math> on bond resistance <math>\tau_{Rk}</math></b>									
Cracked and uncracked concrete: Factor for concrete strength	$\psi_c$	C30/37		1,04					
		C40/45		1,07					
		C50/60		1,1					
Cracked and uncracked concrete: Sustained load factor	$\psi_{sus}^0$	40 °C/24 °C		0,74					
		80 °C/50 °C		0,89					
		120 °C/72 °C		0,72					

**Injection System Hilti HIT-HY 200-R**

**Performances**  
Essential characteristics under tension load in concrete

**Annex C1**



**Table C1: continued**

<b>Concrete cone failure</b>			
Factor for uncracked concrete	$k_{Ucr,N}$	[-]	11,0
Factor for cracked concrete	$k_{Cr,N}$	[-]	7,7
Edge distance	$c_{Cr,N}$	[mm]	$1,5 \cdot h_{ef}$
Spacing	$s_{Cr,N}$	[mm]	$3,0 \cdot h_{ef}$
<b>Splitting failure</b>			
Edge distance $c_{Cr,sp}$ [mm] for	$h / h_{ef} \geq 2,0$		$1,0 \cdot h_{ef}$
	$2,0 > h / h_{ef} > 1,3$		$4,6 \cdot h_{ef} - 1,8 \cdot h$
	$h / h_{ef} \leq 1,3$		$2,26 \cdot h_{ef}$
Spacing	$s_{Cr,sp}$	[mm]	$2 \cdot c_{Cr,sp}$

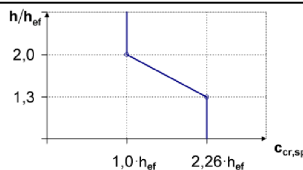

<sup>1)</sup> In absence of national regulations.

**Table C2: Essential characteristics for threaded rod, HAS-U-..., HIT-V-... and AM 8.8 under shear load in concrete**

Threaded rod, HAS-U-..., HIT-V-..., AM 8.8		M8	M10	M12	M16	M20	M24	M27	M30	
<b>Steel failure without lever arm</b>										
Characteristic resistance	$V_{Rk,s}$	[kN]	$0,5 \cdot A_s \cdot f_{uk}$							
Partial factor grade 5.8	$\gamma_{Ms,V}^{1)}$	[-]	1,25							
Partial factor grade 8.8	$\gamma_{Ms,V}^{1)}$	[-]	1,25							
Partial factor HAS-U-R, HIT-V-R	$\gamma_{Ms,V}^{1)}$	[-]	1,56					2,38		
Partial factor HAS-U-HCR, HIT-V-HCR	$\gamma_{Ms,V}^{1)}$	[-]	1,25				1,75			
Ductility factor	$k_7$	[-]	1,0							
<b>Steel failure with lever arm</b>										
Bending moment	$M_{Rk,s}^0$	[Nm]	$1,2 \cdot W_{el} \cdot f_{uk}$							
Ductility factor	$k_7$	[-]	1,0							
<b>Concrete pry-out failure</b>										
Pry-out factor	$k_8$	[-]	2,0							
<b>Concrete edge failure</b>										
Effective length of fastener	$l_f$	[mm]	$\min(h_{ef}; 12 \cdot d_{nom})$						$\min(h_{ef}; 300)$	
Outside diameter of fastener	$d_{nom}$	[mm]	8	10	12	16	20	24	27	30

<sup>1)</sup> In absence of national regulations.

**Injection System Hilti HIT-HY 200-R**

**Performances**

Essential characteristics under tension and shear loads in concrete

**Annex C2**

**Table C3: Essential characteristics for internally threaded sleeve HIS-(R)N under tension load in concrete**

HIS-(R)N			M8	M10	M12	M16	M20
<b>Installation safety factor</b>							
Hammer drilling	$\gamma_{inst}$	[-]	1,0				
Hammer drilling with Hilti hollow drill bit TE-CD or TE-YD	$\gamma_{inst}$	[-]	1,0				
Diamond coring with roughening with Hilti roughening tool TE-YRT	$\gamma_{inst}$	[-]	-	1,0			
<b>Steel failure</b>							
Characteristic resistance HIS-N with screw or threaded rod grade 8.8	$N_{Rk,s}$	[kN]	25	46	67	125	116
Partial factor	$\gamma_{Ms,N^{1)}$	[-]	1,50				
Characteristic resistance HIS-RN with screw or threaded rod grade 70	$N_{Rk,s}$	[kN]	26	41	59	110	166
Partial factor	$\gamma_{Ms,N^{1)}$	[-]	1,87				2,4
<b>Combined pull-out and Concrete cone failure</b>							
Effective embedment depth	$h_{ef}$	[mm]	90	110	125	170	205
Effective fastener diameter	$d_1$	[mm]	12,5	16,5	20,5	25,4	27,6
Characteristic bond resistance in uncracked concrete C20/25							
Temperature range I: 40 °C/24 °C	$\tau_{Rk,ucr}$	[N/mm <sup>2</sup> ]	13				
Temperature range II: 80 °C/50 °C	$\tau_{Rk,ucr}$	[N/mm <sup>2</sup> ]	11				
Temperature range III: 120 °C/72 °C	$\tau_{Rk,ucr}$	[N/mm <sup>2</sup> ]	9,5				
Characteristic bond resistance in cracked concrete C20/25							
Temperature range I: 40 °C/24 °C	$\tau_{Rk,cr}$	[N/mm <sup>2</sup> ]	7				
Temperature range II: 80 °C/50 °C	$\tau_{Rk,cr}$	[N/mm <sup>2</sup> ]	5,5				
Temperature range III: 120 °C/72 °C	$\tau_{Rk,cr}$	[N/mm <sup>2</sup> ]	5				
<b>Influence factors <math>\psi</math> on bond resistance <math>\tau_{Rk}</math></b>							
Cracked and uncracked concrete: Factor for concrete strength	$\psi_c$	C30/37	1,04				
		C40/45	1,07				
		C50/60	1,1				
Cracked and uncracked concrete: Sustained load factor	$\psi^0_{sus}$	40 °C/24 °C	0,74				
		80 °C/50 °C	0,89				
		120 °C/72 °C	0,72				

**Injection System Hilti HIT-HY 200-R**

**Performances**  
Essential characteristics under tension loads in concrete

**Annex C3**

**Table C3: continued**

<b>Concrete cone failure</b>			
Factor for uncracked concrete	$k_{Ucr,N}$	[-]	11,0
Factor for cracked concrete	$k_{Cr,N}$	[-]	7,7
Edge distance	$c_{Cr,N}$	[mm]	$1,5 \cdot h_{ef}$
Spacing	$s_{Cr,N}$	[mm]	$3,0 \cdot h_{ef}$
<b>Splitting failure</b>			
Edge distance $c_{Cr,sp}$ [mm] for	$h / h_{ef} \geq 2,0$		$1,0 \cdot h_{ef}$
	$2,0 > h / h_{ef} > 1,3$		$4,6 h_{ef} - 1,8 h$
	$h / h_{ef} \leq 1,3$		$2,26 h_{ef}$
Spacing	$s_{Cr,sp}$	[mm]	$2 \cdot c_{Cr,sp}$

<sup>1)</sup> In absence of national regulations.

**Table C4: Essential characteristics for internally threaded sleeve HIS-(R)N under shear load in concrete**

HIS-(R)N		M8	M10	M12	M16	M20
<b>Steel failure without lever arm</b>						
Characteristic resistance HIS-N with screw or threaded rod grade 8.8	$V_{Rk,s}$ [kN]	13	23	34	63	58
Partial factor	$\gamma_{Ms,V}^{1)}$ [-]	1,25				
Characteristic resistance HIS-RN with screw or threaded rod grade 70	$V_{Rk,s}$ [kN]	13	20	30	55	83
Partial factor	$\gamma_{Ms,V}^{1)}$ [-]	1,56				2,0
Ductility factor	$k_7$ [-]	1,0				
<b>Steel failure with lever arm</b>						
HIS-N with screw or threaded rod grade 8.8	$M^0_{Rk,s}$ [Nm]	30	60	105	266	519
HIS-RN with screw or threaded rod grade 70	$M^0_{Rk,s}$ [Nm]	26	52	92	233	454
Ductility factor	$k_7$ [-]	1,0				
<b>Concrete pry-out failure</b>						
Pry-out factor	$k_8$ [-]	2,0				
<b>Concrete edge failure</b>						
Effective length of fastener	$l_f$ [mm]	90	110	125	170	205
Outside diameter of fastener	$d_{nom}$ [mm]	12,5	16,5	20,5	25,4	27,6

<sup>1)</sup> In absence of national regulations.

**Injection System Hilti HIT-HY 200-R**

**Performances**  
Essential characteristics under tension and shear loads in concrete

**Annex C4**

**Table C5: Essential characteristics for Hilti tension anchor HZA / HZA-R under tension load in concrete**

Hilti tension anchor HZA, HZA-R			M12	M16	M20	M24	M27
<b>Installation safety factor</b>							
Hammer drilling	$\gamma_{inst}$	[-]	1,0				
Hammer drilling with Hilti hollow drill bit TE-CD or TE-YD	$\gamma_{inst}$	[-]	1,0				
Diamond coring with roughening with Hilti roughening tool TE-YRT	$\gamma_{inst}$	[-]	-	1,0			
<b>Steel failure</b>							
Characteristic resistance HZA	$N_{Rk,s}$	[kN]	46	86	135	194	253
Characteristic resistance HZA-R	$N_{Rk,s}$	[kN]	62	111	173	248	-
Partial factor	$\gamma_{Ms}^{1)}$	[-]	1,4				
<b>Combined pull-out and concrete cone failure</b>							
Diameter of rebar	d	[mm]	12	16	20	25	28
Characteristic bond resistance in uncracked concrete C20/25							
Effective anchorage depth	HZA	$h_{ef}$	[mm]		$h_{nom} - 20$		
	HZA-R	$h_{ef}$	[mm]		$h_{nom} - 100$		-
Temperature range I: 40 °C/24 °C	$\tau_{Rk,ucr}$	[N/mm <sup>2</sup> ]	12				
Temperature range II: 80 °C/50 °C	$\tau_{Rk,ucr}$	[N/mm <sup>2</sup> ]	10				
Temperature range III: 120 °C/72 °C	$\tau_{Rk,ucr}$	[N/mm <sup>2</sup> ]	8,5				
Characteristic bond resistance in cracked concrete C20/25							
Temperature range I: 40 °C/24 °C	$\tau_{Rk,cr}$	[N/mm <sup>2</sup> ]	7				
Temperature range II: 80 °C/50 °C	$\tau_{Rk,cr}$	[N/mm <sup>2</sup> ]	5,5				
Temperature range III: 120 °C/72 °C	$\tau_{Rk,cr}$	[N/mm <sup>2</sup> ]	5				
<b>Influence factors <math>\psi</math> on bond resistance <math>\tau_{Rk}</math></b>							
Cracked and uncracked concrete: Factor for concrete strength	$\psi_c$	C30/37	1,04				
		C40/45	1,07				
		C50/60	1,1				
Cracked and uncracked concrete: Sustained load factor	$\psi^{0_{sus}}$	40 °C/24 °C	0,74				
		80 °C/50 °C	0,89				
		120 °C/72 °C	0,72				

**Injection System Hilti HIT-HY 200-R**

**Performances**  
Essential characteristics under tension loads in concrete

**Annex C5**

**Table C5: continued**

<b>Concrete cone failure</b>				
Effective anchorage depth	HZA	$h_{ef}$	[mm]	$h_{nom}$
	HZA-R	$h_{ef}$	[mm]	$h_{nom}$ -
Factor for uncracked concrete	$k_{ucr}$		[-]	11,0
Factor for cracked concrete	$k_{cr}$		[-]	7,7
Edge distance	$c_{Cr,N}$		[mm]	$1,5 \cdot h_{ef}$
Spacing	$s_{Cr,N}$		[mm]	$3,0 \cdot h_{ef}$
<b>Splitting failure relevant for uncracked concrete</b>				
Edge distance $c_{Cr,sp}$ [mm] for	$h / h_{ef} \geq 2,0$			$1,0 \cdot h_{ef}$
	$2,0 > h / h_{ef} > 1,3$			$4,6 \cdot h_{ef} - 1,8 \cdot h$
	$h / h_{ef} \leq 1,3$			$2,26 \cdot h_{ef}$
Spacing	$s_{Cr,sp}$		[mm]	$2 \cdot c_{Cr,sp}$

<sup>1)</sup> In absence of national regulations.

**Table C6: Essential characteristics for Hilti tension anchor HZA, HZA-R under shear load in concrete**

Hilti tension anchor HZA, HZA-R			M12	M16	M20	M24	M27	
<b>Steel failure without lever arm</b>								
Characteristic resistance HZA	$V_{Rk,s}$	[kN]	23	43	67	97	126	
Characteristic resistance HZA-R	$V_{Rk,s}$	[kN]	31	55	86	124	-	
Partial factor	$\gamma_{Ms}^{1)}$	[-]	1,5					
Ductility factor	$k_7$	[-]	1,0					
<b>Steel failure with lever arm</b>								
HZA	$M^0_{Rk,s}$	[Nm]	72	183	357	617	915	
HZA-R	$M^0_{Rk,s}$	[Nm]	97	234	457	790	-	
Ductility factor	$k_7$	[-]	1,0					
<b>Concrete pry-out failure</b>								
Pry-out factor	$k_8$	[-]	2,0					
<b>Concrete edge failure</b>								
Effective length of fastener	$l_f$	[mm]	$\min(h_{nom}; 12 \cdot d_{nom})$				$\min(h_{nom} 300)$	
Outside diameter of fastener	$d_{nom}$	[mm]	12	16	20	24	27	

<sup>1)</sup> In absence of national regulations.

**Injection System Hilti HIT-HY 200-R**

**Performances**  
Essential characteristics under tension and shear loads in concrete

**Annex C6**

**Table C7: Essential characteristics for rebar under tension load in concrete**

Rebar		φ 8	φ 10	φ 12	φ 14	φ 16	φ 20	φ 25	φ 26	φ 28	φ 30	φ 32		
<b>Installation safety factor</b>														
Hammer drilling	$\gamma_{inst}$	[-]						1,0						
Hammer drilling with Hilti hollow drill bit TE-CD or TE-YD	$\gamma_{inst}$	[-]						1,0						
Diamond coring with roughening with Hilti roughening tool TE-YRT	$\gamma_{inst}$	[-]						-						
<b>Steel failure</b>														
Characteristic resistance Rebar B500B acc. to DIN 488:2009-08	$N_{Rk,s}$	[kN]	28	43	62	85	111	173	270	292	339	388	442	
Partial factor	$\gamma_{Ms,N^1)}$	[-]						1,4						
<b>Combined pull-out and concrete cone failure</b>														
Diameter of rebar	d	[mm]	8	10	12	14	16	20	25	26	28	30	32	
Characteristic bond resistance in uncracked concrete C20/25														
Temperature range I: 40°C/24°C	$\tau_{Rk,ucr}$	[N/mm <sup>2</sup> ]							12					
Temperature range II: 80°C/50°C	$\tau_{Rk,ucr}$	[N/mm <sup>2</sup> ]							10					
Temperature range III: 120°C/72°C	$\tau_{Rk,ucr}$	[N/mm <sup>2</sup> ]							8,5					
Characteristic bond resistance in cracked concrete C20/25														
Temperature range I: 40°C/24°C	$\tau_{Rk,cr}$	[N/mm <sup>2</sup> ]	-	5							7			
Temperature range II: 80°C/50°C	$\tau_{Rk,cr}$	[N/mm <sup>2</sup> ]	-	4							5,5			
Temperature range III: 120°C/72°C	$\tau_{Rk,cr}$	[N/mm <sup>2</sup> ]	-	3,5							5			
<b>Influence factors <math>\psi</math> on bond resistance <math>\tau_{Rk}</math></b>														
Cracked and uncracked concrete: Factor for concrete strength	$\psi_c$	C30/37							1,04					
		C40/45							1,07					
		C50/60							1,1					
Cracked and uncracked concrete: Sustained load factor	$\psi_{sus}^0$	40 °C/24 °C							0,74					
		80 °C/50 °C							0,89					
		120 °C/72 °C							0,72					

**Injection System Hilti HIT-HY 200-R**

**Performances**  
Essential characteristics under tension load in concrete

**Annex C7**

**Table C7: continued**

<b>Concrete cone failure</b>		
Factor for uncracked concrete	$k_{ucr,N}$ [-]	11,0
Factor for cracked concrete	$k_{cr,N}$ [-]	7,7
Edge distance	$c_{cr,N}$ [mm]	$1,5 \cdot h_{ef}$
Spacing	$s_{cr,N}$ [mm]	$3,0 \cdot h_{ef}$
<b>Splitting failure relevant for uncracked concrete</b>		
Edge distance $c_{cr,sp}$ [mm] for	$h / h_{ef} \geq 2,0$	$1,0 \cdot h_{ef}$
	$2,0 > h / h_{ef} > 1,3$	$4,6 \cdot h_{ef} - 1,8 \cdot h$
	$h / h_{ef} \leq 1,3$	$2,26 \cdot h_{ef}$
Spacing	$s_{cr,sp}$ [mm]	$2 c_{cr,sp}$

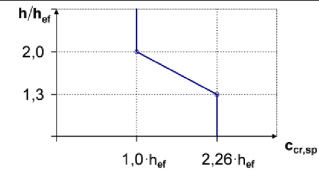

<sup>1)</sup> In absence of national regulations.

**Table C8: Essential characteristics for rebar under shear load in concrete**

Rebar		$\phi 8$	$\phi 10$	$\phi 12$	$\phi 14$	$\phi 16$	$\phi 20$	$\phi 25$	$\phi 26$	$\phi 28$	$\phi 30$	$\phi 32$	
<b>Steel failure without lever arm</b>													
Characteristic resistance Rebar B500B acc. to DIN 488:2009-08	$V_{Rk,s}$ [kN]	14	22	31	42	55	86	135	146	169	194	221	
Partial factor	$\gamma_{Ms,V}$ <sup>1)</sup> [-]	1,5											
Ductility factor	$k_7$ [-]	1,0											
<b>Steel failure with lever arm</b>													
Rebar B500B acc. to DIN 488:2009-08	$M^0_{Rk,s}$ [Nm]	33	65	112	178	265	518	1012	1139	1422	1749	2123	
Ductility factor	$k_7$ [-]	1,0											
<b>Concrete pry-out failure</b>													
Pry-out factor	$k_8$ [-]	2,0											
<b>Concrete edge failure</b>													
Effective length of fastener	$l_f$ [mm]	$\min(h_{ef}; 12 \cdot d_{nom})$						$\min(h_{nom}; 300)$					
Outside diameter of fastener	$d_{nom}$ [mm]	8	10	12	14	16	20	25	26	28	30	32	

<sup>1)</sup> In absence of national regulations.

**Injection System Hilti HIT-HY 200-R**

**Performances**

Essential characteristics under tension and shear loads in concrete

**Annex C8**

**Table C9: Displacements under tension load**

Threaded rod, HAS-U-..., HIT-V-..., AM 8.8		M8	M10	M12	M16	M20	M24	M27	M30	
Uncracked concrete temperature range I : 40°C / 24°C										
Displacement	$\delta_{N0}$	[mm/(N/mm <sup>2</sup> )]	0,02	0,03	0,03	0,04	0,06	0,07	0,07	0,08
	$\delta_{N\infty}$	[mm/(N/mm <sup>2</sup> )]	0,04	0,05	0,06	0,08	0,10	0,13	0,14	0,16
Uncracked concrete temperature range II : 80°C / 50°C										
Displacement	$\delta_{N0}$	[mm/(N/mm <sup>2</sup> )]	0,03	0,04	0,05	0,06	0,08	0,09	0,10	0,12
	$\delta_{N\infty}$	[mm/(N/mm <sup>2</sup> )]	0,04	0,05	0,06	0,09	0,11	0,13	0,15	0,16
Uncracked concrete temperature range III : 120°C / 72°C										
Displacement	$\delta_{N0}$	[mm/(N/mm <sup>2</sup> )]	0,04	0,05	0,06	0,08	0,10	0,12	0,13	0,16
	$\delta_{N\infty}$	[mm/(N/mm <sup>2</sup> )]	0,04	0,05	0,07	0,09	0,11	0,13	0,15	0,17
Cracked concrete temperature range I : 40°C / 24°C										
Displacement	$\delta_{N0}$	[mm/(N/mm <sup>2</sup> )]	0,07							
	$\delta_{N\infty}$	[mm/(N/mm <sup>2</sup> )]	0,16							
Cracked concrete temperature range II : 80°C / 50°C										
Displacement	$\delta_{N0}$	[mm/(N/mm <sup>2</sup> )]	0,10							
	$\delta_{N\infty}$	[mm/(N/mm <sup>2</sup> )]	0,22							
Cracked concrete temperature range III : 120°C / 72°C										
Displacement	$\delta_{N0}$	[mm/(N/mm <sup>2</sup> )]	0,13							
	$\delta_{N\infty}$	[mm/(N/mm <sup>2</sup> )]	0,29							

**Table C10: Displacements under shear load**

Threaded rod, HAS-U-..., HIT-V-..., AM 8.8		M8	M10	M12	M16	M20	M24	M27	M30	
Displacement	$\delta_{V0}$	[mm/kN]	0,06	0,06	0,05	0,04	0,04	0,03	0,03	0,03
	$\delta_{V\infty}$	[mm/kN]	0,09	0,08	0,08	0,06	0,06	0,05	0,05	0,05

**Injection System Hilti HIT-HY 200-R**

**Performances**

Displacements with threaded rod, HAS-U-..., HIT-V-... and AM 8.8

**Annex C9**



**Table C11: Displacements under tension load**

HIS-(R)N			M8	M10	M12	M16	M20	
Uncracked concrete temperature range I : 40°C / 24°C								
Displacement	$\delta_{N0}$	[mm/(N/mm <sup>2</sup> )]	0,03	0,05	0,06	0,07	0,08	
	$\delta_{N\infty}$	[mm/(N/mm <sup>2</sup> )]	0,06	0,09	0,11	0,13	0,14	
Uncracked concrete temperature range II : 80°C / 50°C								
Displacement	$\delta_{N0}$	[mm/(N/mm <sup>2</sup> )]	0,05	0,06	0,08	0,10	0,11	
	$\delta_{N\infty}$	[mm/(N/mm <sup>2</sup> )]	0,07	0,09	0,11	0,13	0,15	
Uncracked concrete temperature range III : 120°C / 72°C								
Displacement	$\delta_{N0}$	[mm/(N/mm <sup>2</sup> )]	0,06	0,08	0,10	0,13	0,14	
	$\delta_{N\infty}$	[mm/(N/mm <sup>2</sup> )]	0,07	0,09	0,11	0,14	0,15	
Cracked concrete temperature range I : 40°C / 24°C								
Displacement	$\delta_{N0}$	[mm/(N/mm <sup>2</sup> )]				0,11		
	$\delta_{N\infty}$	[mm/(N/mm <sup>2</sup> )]				0,16		
Cracked concrete temperature range II : 80°C / 50°C								
Displacement	$\delta_{N0}$	[mm/(N/mm <sup>2</sup> )]				0,15		
	$\delta_{N\infty}$	[mm/(N/mm <sup>2</sup> )]				0,22		
Cracked concrete temperature range III : 120°C / 72°C								
Displacement	$\delta_{N0}$	[mm/(N/mm <sup>2</sup> )]				0,20		
	$\delta_{N\infty}$	[mm/(N/mm <sup>2</sup> )]				0,29		

**Table C12: Displacements under shear load**

HIS-(R)N			M8	M10	M12	M16	M20
Displacement	$\delta_{V0}$	[mm/kN]	0,06	0,06	0,05	0,04	0,04
	$\delta_{V\infty}$	[mm/kN]	0,09	0,08	0,08	0,06	0,06

**Injection System Hilti HIT-HY 200-R**

**Performances**  
Displacements with HIS-(R)N

**Annex C10**

**Table C13: Displacements under tension load**

Hilti tension anchor HZA, HZA-R		M12	M16	M20	M24	M27
Uncracked concrete temperature range I : 40°C / 24°C						
Displacement	$\delta_{N0}$ [mm/(N/mm <sup>2</sup> )]	0,03	0,04	0,06	0,07	0,08
	$\delta_{N\infty}$ [mm/(N/mm <sup>2</sup> )]	0,06	0,08	0,13	0,13	0,15
Uncracked concrete temperature range II : 80°C / 50°C						
Displacement	$\delta_{N0}$ [mm/(N/mm <sup>2</sup> )]	0,05	0,06	0,08	0,10	0,11
	$\delta_{N\infty}$ [mm/(N/mm <sup>2</sup> )]	0,06	0,09	0,14	0,14	0,15
Uncracked concrete temperature range III : 120°C / 72°C						
Displacement	$\delta_{N0}$ [mm/(N/mm <sup>2</sup> )]	0,06	0,08	0,10	0,12	0,14
	$\delta_{N\infty}$ [mm/(N/mm <sup>2</sup> )]	0,07	0,09	0,14	0,14	0,16
Cracked concrete temperature range I : 40°C / 24°C						
Displacement	$\delta_{N0}$ [mm/(N/mm <sup>2</sup> )]	0,11				
	$\delta_{N\infty}$ [mm/(N/mm <sup>2</sup> )]	0,16				
Cracked concrete temperature range II : 80°C / 50°C						
Displacement	$\delta_{N0}$ [mm/(N/mm <sup>2</sup> )]	0,15				
	$\delta_{N\infty}$ [mm/(N/mm <sup>2</sup> )]	0,22				
Cracked concrete temperature range III : 120°C / 72°C						
Displacement	$\delta_{N0}$ [mm/(N/mm <sup>2</sup> )]	0,20				
	$\delta_{N\infty}$ [mm/(N/mm <sup>2</sup> )]	0,29				

**Table C14: Displacements under shear load**

Hilti tension anchor HZA, HZA-R		M12	M16	M20	M24	M27
Displacement	$\delta_{V0}$ [mm/kN]	0,05	0,04	0,04	0,03	0,03
	$\delta_{V\infty}$ [mm/kN]	0,08	0,06	0,06	0,05	0,05

**Injection System Hilti HIT-HY 200-R**

**Performances**  
Displacements with HZA and HZA-R

**Annex C11**

**Table C15: Displacements under tension load**

Rebar		φ 8	φ 10	φ 12	φ 14	φ 16	φ 20	φ 25	φ 26	φ 28	φ 30	φ 32
Uncracked concrete temperature range I : 40°C / 24°C												
Displacement	$\delta_{N0}$ [mm/(N/mm <sup>2</sup> )]	0,02	0,03	0,03	0,04	0,04	0,06	0,07	0,08	0,08	0,09	0,09
	$\delta_{N\infty}$ [mm/(N/mm <sup>2</sup> )]	0,04	0,05	0,06	0,07	0,08	0,10	0,13	0,14	0,15	0,16	0,17
Uncracked concrete temperature range II : 80°C / 50°C												
Displacement	$\delta_{N0}$ [mm/(N/mm <sup>2</sup> )]	0,03	0,04	0,05	0,05	0,06	0,08	0,10	0,11	0,11	0,12	0,12
	$\delta_{N\infty}$ [mm/(N/mm <sup>2</sup> )]	0,04	0,05	0,06	0,07	0,09	0,11	0,14	0,15	0,15	0,16	0,17
Uncracked concrete temperature range III : 120°C / 72°C												
Displacement	$\delta_{N0}$ [mm/(N/mm <sup>2</sup> )]	0,04	0,05	0,06	0,07	0,08	0,10	0,12	0,13	0,14	0,15	0,16
	$\delta_{N\infty}$ [mm/(N/mm <sup>2</sup> )]	0,04	0,05	0,07	0,08	0,09	0,11	0,14	0,15	0,16	0,17	0,18
Cracked concrete temperature range I : 40°C / 24°C												
Displacement	$\delta_{N0}$ [mm/(N/mm <sup>2</sup> )]							0,11				
	$\delta_{N\infty}$ [mm/(N/mm <sup>2</sup> )]							0,16				
Cracked concrete temperature range II : 80°C / 50°C												
Displacement	$\delta_{N0}$ [mm/(N/mm <sup>2</sup> )]							0,15				
	$\delta_{N\infty}$ [mm/(N/mm <sup>2</sup> )]							0,22				
Cracked concrete temperature range III : 120°C / 72°C												
Displacement	$\delta_{N0}$ [mm/(N/mm <sup>2</sup> )]							0,20				
	$\delta_{N\infty}$ [mm/(N/mm <sup>2</sup> )]							0,29				

**Table C16: Displacements under shear load**

Rebar		φ 8	φ 10	φ 12	φ 14	φ 16	φ 20	φ 25	φ 26	φ 28	φ 30	φ 32
Displacement	$\delta_{V0}$ [mm/kN]	0,06	0,05	0,05	0,04	0,04	0,04	0,03	0,03	0,03	0,03	0,03
	$\delta_{V\infty}$ [mm/kN]	0,09	0,08	0,07	0,06	0,06	0,05	0,05	0,05	0,04	0,04	0,04

**Injection System Hilti HIT-HY 200-R**

**Performances**  
Displacements with rebar

**Annex C12**

**Table C17: Essential characteristics for threaded rod, HAS-U-..., HIT-V-... and AM 8.8 under tension load for seismic performance category C1**

Threaded rod, HAS-U-..., HIT-V-... and AM 8.8	M8	M10	M12	M16	M20	M24	M27	M30	
<b>Steel failure</b>									
HAS-U-5.8(F), HIT-V-5.8(F), threaded rod 5.8	$N_{Rk,s,seis}$ [kN]	-	29	42	79	123	177	230	281
HAS-U-8.8(F), HIT-V-8.8(F), threaded rod 8.8, AM 8.8	$N_{Rk,s,seis}$ [kN]	-	46	67	126	196	282	367	449
HAS-U-R, HIT-V-R, threaded rod A4-70	$N_{Rk,s,seis}$ [kN]	-	41	59	110	172	247	230	281
HAS-U-HCR, HIT-V-HCR, threaded rod HCR-80	$N_{Rk,s,seis}$ [kN]	-	46	67	126	196	247	321	393
<b>Combined pullout and concrete cone failure</b>									
Characteristic bond resistance in cracked concrete C20/25									
Temperature range I: 40 °C/24 °C	$\tau_{Rk,seis}$ [N/mm <sup>2</sup> ]	-	5,2	7,0					
Temperature range II: 80 °C/50 °C	$\tau_{Rk,seis}$ [N/mm <sup>2</sup> ]	-	3,9	5,7					
Temperature range III: 120 °C/72 °C	$\tau_{Rk,seis}$ [N/mm <sup>2</sup> ]	-	3,5	4,8					

**Table C18: Essential characteristics for threaded rod, HAS-U-..., HIT-V-... and AM 8.8 under shear load for seismic performance category C1**

Threaded rod, HAS-U-..., HIT-V-..., AM 8.8	M8	M10	M12	M16	M20	M24	M27	M30	
<b>Steel failure without lever arm</b>									
HAS-U-5.8(F), HIT-V-5.8(F), threaded rod 5.8	$V_{Rk,s,seis}$ [kN]	-	11	15	27	43	62	81	98
HAS-U-8.8(F), HIT-V-8.8(F), threaded rod 8.8, AM 8.8	$V_{Rk,s,seis}$ [kN]	-	16	24	44	69	99	129	157
HAS-U-R, HIT-V-R, threaded rod A4-70	$V_{Rk,s,seis}$ [kN]	-	14	21	39	60	87	81	98
HAS-U-HCR, HIT-V-HCR, threaded rod HCR-80	$V_{Rk,s,seis}$ [kN]	-	16	24	44	69	87	113	137

**Table C19: Displacements under tension load for seismic performance category C1**

Threaded rod, HAS-U-..., HIT-V-..., AM 8.8	M8	M10	M12	M16	M20	M24	M27	M30
Displacement <sup>1)</sup>	$\delta_{N,seis}$ [mm]	-	0,8	0,8	0,8	0,8	0,8	0,8

<sup>1)</sup> Maximum displacement during cycling (seismic event).

**Table C20: Displacements under shear load for seismic performance category C1**

Threaded rod, HAS-U-..., HIT-V-..., AM 8.8	M8	M10	M12	M16	M20	M24	M27	M30	
Displacement <sup>1)</sup>	$\delta_{V,seis}$ [mm]	-	3,5	3,8	4,4	5,0	5,6	6,1	6,5

<sup>1)</sup> Maximum displacement during cycling (seismic event).

**Injection System Hilti HIT-HY 200-R**

**Performances**

Essential characteristics for seismic performance category C1 and displacements.

**Annex C13**

**Table C21: Essential characteristics for Hilti tension anchor HZA, HZA-R under tension load for seismic performance category C1**

Hilti tension anchor HZA, HZA-R		M12	M16	M20	M24	M27
<b>Steel failure</b>						
Characteristic resistance HZA	$N_{Rk,s,seis}$ [kN]	46	86	135	194	253
Characteristic resistance HZA-R	$N_{Rk,s,seis}$ [kN]	62	111	173	248	-
Partial factor	$\gamma_{Ms,N,seis}^{1)}$ [-]	1,4				
<b>Combined pull-out and concrete cone failure</b>						
Diameter of rebar	d [mm]	12	16	20	25	28
Characteristic bond resistance in cracked concrete C20/25						
Temperature range I: 40°C/24°C	$\tau_{Rk,cr}$ [N/mm <sup>2</sup> ]	6,1				
Temperature range II: 80°C/50°C	$\tau_{Rk,cr}$ [N/mm <sup>2</sup> ]	4,8				
Temperature range III: 120°C/72°C	$\tau_{Rk,cr}$ [N/mm <sup>2</sup> ]	4,4				

<sup>1)</sup> In absence of national regulations.

**Table C22: Essential characteristics for Hilti tension anchor HZA, HZA-R under shear load for seismic performance category C1**

Hilti tension anchor HZA, HZA-R		M12	M16	M20	M24	M27
<b>Steel failure without lever arm</b>						
Characteristic resistance HZA	$V_{Rk,s,seis}$ [kN]	16	30	47	68	88
Characteristic resistance HZA-R	$V_{Rk,s,seis}$ [kN]	22	39	60	124	-
Partial factor	$\gamma_{Ms,V,seis}^{1)}$ [-]	1,5				

<sup>1)</sup> In absence of national regulations.

**Table C23: Displacements under tension load for seismic performance category C1**

Hilti tension anchor HZA, HZA-R		M12	M16	M20	M24	M27
Displacement <sup>1)</sup>	$\delta_{N,seis}$ [mm]	1,3	1,3	1,3	1,3	1,3

<sup>1)</sup> Maximum displacement during cycling (seismic event).

**Table C24: Displacements under shear load for seismic performance category C1**

Hilti tension anchor HZA, HZA-R		M12	M16	M20	M24	M27
Displacement <sup>1)</sup>	$\delta_{V,seis}$ [mm]	3,8	4,4	5,0	5,6	6,1

<sup>1)</sup> Maximum displacement during cycling (seismic event).

**Injection System Hilti HIT-HY 200-R**

**Performances**

Essential characteristics for seismic performance category C1 and displacements.

**Annex C14**

**Table C25: Essential characteristics for rebar under tension load for seismic performance category C1**

Rebar	φ 8	φ 10	φ 12	φ 14	φ 16	φ 20	φ 25	φ 26	φ 28	φ 30	φ 32	
<b>Steel failure</b>												
Characteristic resistance for rebar B500B acc. to DIN 488:2009-08	$N_{Rk,seis}$ [kN]	-	43	62	85	111	173	270	292	339	388	442
<b>Combined pull-out and Concrete cone failure</b>												
Diameter of rebar	d [mm]	-	10	12	14	16	20	25	26	28	30	32
<b>Characteristic bond resistance in cracked concrete C20/25</b>												
Temperature range I: 40°C/24°C	$\tau_{Rk,cr}$ [N/mm <sup>2</sup> ]	-	4,4	6,1								
Temperature range II: 80°C/50°C	$\tau_{Rk,cr}$ [N/mm <sup>2</sup> ]	-	3,5	4,8								
Temperature range III: 120°C/72°C	$\tau_{Rk,cr}$ [N/mm <sup>2</sup> ]	-	3	4,4								

**Table C26: Essential characteristics for rebar under shear loads for seismic performance category C1**

Rebar	φ 8	φ 10	φ 12	φ 14	φ 16	φ 20	φ 25	φ 26	φ 28	φ 30	φ 32	
<b>Steel failure without lever arm</b>												
Characteristic resistance for rebar B500B acc. to DIN 488:2009-08	$V_{Rk,s,seis}$ [kN]	-	15	22	29	39	60	95	102	118	135	165

**Table C27: Displacements under tension load for seismic performance category C1**

Rebar	φ 8	φ 10	φ 12	φ 14	φ 16	φ 20	φ 25	φ 26	φ 28	φ 30	φ 32
Displacement <sup>1)</sup>	$\delta_{N,seis}$ [mm]	-	1,3	1,3	1,3	1,3	1,3	1,3	1,3	1,3	1,3

<sup>1)</sup> Maximum displacement during cycling (seismic event).

**Table C28: Displacements under shear load for seismic performance category C1**

Rebar	φ 8	φ 10	φ 12	φ 14	φ 16	φ 20	φ 25	φ 26	φ 28	φ 30	φ 32	
Displacement <sup>1)</sup>	$\delta_{V,seis}$ [mm]	-	3,5	3,8	4,1	4,4	5,0	5,8	6,2	6,2	6,8	6,8

<sup>1)</sup> Maximum displacement during cycling (seismic event).

**Injection System Hilti HIT-HY 200-R**

**Performances**

Essential characteristics for seismic performance category C1 and displacements.

**Annex C15**

**Table C29: Essential characteristics for threaded rod, HAS-U-..., HIT-V... and AM 8.8 under tension load for seismic performance category C2**

Threaded rod, HAS-U-..., HIT-V-..., AM 8.8	M8	M10	M12	M16	M20	M24	M27	M30
<b>Steel failure</b>								
HAS-U (-F) 8.8, HIT-V (-F) 8.8, AM (HDG) 8.8 Commercial standard threaded rod electroplated zinc coated 8.8	$N_{Rk,s,seis}$ [kN]		-	126	196	282	-	
<b>Combined pullout and concrete cone failure</b>								
Characteristic bond resistance in cracked concrete C20/25 in hammer drilled holes and hammer drilled holes with Hilti hollow drill bit TE-CD or TE-YD								
Temperature range I: 40 °C/24 °C	$\tau_{Rk,s,seis}$ [N/mm <sup>2</sup> ]	-	3,9	4,3	3,5	-		
Temperature range II: 80 °C/50 °C	$\tau_{Rk,s,seis}$ [N/mm <sup>2</sup> ]	-	3,3	3,7	2,9	-		
Temperature range III: 120 °C/72 °C	$\tau_{Rk,s,seis}$ [N/mm <sup>2</sup> ]	-	2,8	3,2	2,5	-		

**Table C30: Essential characteristics for threaded rod, HAS-U-..., HIT-V... and AM 8.8 under shear load for seismic performance category C2**

Threaded rod, HAS-U-..., HIT-V-..., AM 8.8	M8	M10	M12	M16	M20	M24	M27	M30
<b>Steel failure without lever arm with Hilti Filling Set</b>								
HAS-U 8.8, HIT-V 8.8, AM 8.8	$V_{Rk,s,seis}$ [kN]		-	46	77	103	-	
<b>Steel failure without lever arm without Hilti Filling Set</b>								
HAS-U 8.8, HIT-V 8.8, AM 8.8	$V_{Rk,s,seis}$ [kN]		-	40	71	90	-	
HAS-U-F 8.8, HIT-V-F 8.8, AM-HDG 8.8	$V_{Rk,s,seis}$ [kN]		-	30	46	66	-	
Commercial standard threaded rod, electroplated zinc coated 8.8	$V_{Rk,s,seis}$ [kN]		-	28	50	63	-	

**Injection System Hilti HIT-HY 200-R**

**Performances**

Essential characteristics for seismic performance category C2.

**Annex C16**

**Table C31: Displacements under tension load for seismic performance category C2**

Threaded rod, HAS-U-..., HIT-V-..., AM 8.8	M8	M10	M12	M16	M20	M24	M27	M30
Displacement DLS, HAS-U (-F) 8.8, HIT-V (-F) 8.8, AM (HDG) 8.8	$\delta_{N,seis(DLS)}$ [mm]			-	0,2	0,5	0,4	-
Displacement ULS, HAS-U (-F) 8.8, HIT-V (-F) 8.8, AM (HDG) 8.8	$\delta_{N,seis(ULS)}$ [mm]			-	0,6	0,8	1,0	-

**Table C32: Displacements under shear load for seismic performance category C2**

Threaded rod, HAS-U-..., HIT-V-..., AM 8.8	M8	M10	M12	M16	M20	M24	M27	M30
<b>Installation with Hilti Filling Set</b>								
Displacement DLS, HAS-U 8.8, HIT-V 8.8, AM 8.8	$\delta_{V,seis(DLS)}$ [mm]			-	1,2	1,4	1,1	-
Displacement ULS, HAS-U 8.8, HIT-V 8.8, AM 8.8	$\delta_{V,seis(ULS)}$ [mm]			-	3,2	3,8	2,6	-
<b>Installation without Hilti Filling Set</b>								
Displacement DLS, HAS-U 8.8, HIT-V 8.8, AM 8.8	$\delta_{V,seis(DLS)}$ [mm]			-	3,2	2,5	3,5	-
Displacement DLS, HAS-U-F 8.8, HIT-V-F 8.8, AM HDG 8.8	$\delta_{V,seis(DLS)}$ [mm]			-	2,3	3,8	3,7	-
Displacement ULS, HAS-U 8.8, HIT-V 8.8, AM 8.8	$\delta_{V,seis(ULS)}$ [mm]			-	9,2	7,1	10,2	-
Displacement ULS, HAS-U-F 8.8, HIT-V-F 8.8, AM HDG 8.8	$\delta_{V,seis(ULS)}$ [mm]			-	4,3	9,1	8,4	-

**Injection System Hilti HIT-HY 200-R**

**Performances**  
Displacements for seismic performance category C2.

**Annex C17**