

Approval body for construction products
and types of construction

Bautechnisches Prüfamt

An institution established by the Federal and
Laender Governments



European Technical Assessment

ETA-19/0205
of 14 May 2019

English translation prepared by DIBt - Original version in German language

General Part

Technical Assessment Body issuing the
European Technical Assessment:

Deutsches Institut für Bautechnik

Trade name of the construction product

TILCA® TIM U-H Injection system for concrete

Product family
to which the construction product belongs

Bonded anchor for use in concrete

Manufacturer

EFCO Befestigungstechnik AG
Grabenstraße 1
8606 NÄNIKON
SCHWEIZ

Manufacturing plant

EFCO AG, Plant 2

This European Technical Assessment
contains

31 pages including 3 annexes which form an integral part
of this assessment

This European Technical Assessment is
issued in accordance with Regulation (EU)
No 305/2011, on the basis of

EAD 330499-01-0601

The European Technical Assessment is issued by the Technical Assessment Body in its official language. Translations of this European Technical Assessment in other languages shall fully correspond to the original issued document and shall be identified as such.

Communication of this European Technical Assessment, including transmission by electronic means, shall be in full. However, partial reproduction may only be made with the written consent of the issuing Technical Assessment Body. Any partial reproduction shall be identified as such.

This European Technical Assessment may be withdrawn by the issuing Technical Assessment Body, in particular pursuant to information by the Commission in accordance with Article 25(3) of Regulation (EU) No 305/2011.

Specific Part

1 Technical description of the product

The "TILCA® TIM U-H Injection system for concrete" is a bonded anchor consisting of a cartridge with injection mortar TILCA® TIM U-H and a steel element. The steel element consist of a commercial threaded rod with washer and hexagon nut in the range of M8 to M30, reinforcing bar in the range of diameter Ø8 to Ø32 mm or internal threaded rod IG-M6 to IG-M20.

The steel element is placed into a drilled hole filled with injection mortar and is anchored via the bond between metal part, injection mortar and concrete.

The product description is given in Annex A.

2 Specification of the intended use in accordance with the applicable European Assessment Document

The performances given in Section 3 are only valid if the anchor is used in compliance with the specifications and conditions given in Annex B.

The verifications and assessment methods on which this European Technical Assessment is based lead to the assumption of a working life of the anchor of at least 50 years. The indications given on the working life cannot be interpreted as a guarantee given by the producer, but are to be regarded only as a means for choosing the right products in relation to the expected economically reasonable working life of the works.

3 Performance of the product and references to the methods used for its assessment

3.1 Mechanical resistance and stability (BWR 1)

Essential characteristic	Performance
Characteristic resistance to tension load (static and quasi-static loading)	See Annex C 1, C 2, C 4, C 6
Characteristic resistance to shear load (static and quasi-static loading)	See Annex C 1, C 3, C 5, C 7
Displacements (static and quasi-static loading)	See Annex C 8 to C 10
Characteristic resistance for seismic performance category C1	See Annex C 11 to C 14
Characteristic resistance and displacements for seismic performance category C2	See Annex C 11, C 12, C 15

3.2 Hygiene, health and the environment (BWR 3)

Essential characteristic	Performance
Content, emission and/or release of dangerous substances	No performance assessed

English translation prepared by DIBt

4 Assessment and verification of constancy of performance (AVCP) system applied, with reference to its legal base

In accordance with the European Assessment Document EAD 330499-01-0601 the applicable European legal act is: [96/582/EC].

The system to be applied is: 1

5 Technical details necessary for the implementation of the AVCP system, as provided for in the applicable European Assessment Document

Technical details necessary for the implementation of the AVCP system are laid down in the control plan deposited at Deutsches Institut für Bautechnik.

Issued in Berlin on 14 May 2019 by Deutsches Institut für Bautechnik

BD Dipl.-Ing. Andreas Kummerow
Head of Department

beglaubigt:
Baderschneider

Installation threaded rod M8 up to M30

prepositioned installation or
push through installation (annular gap filled with mortar)

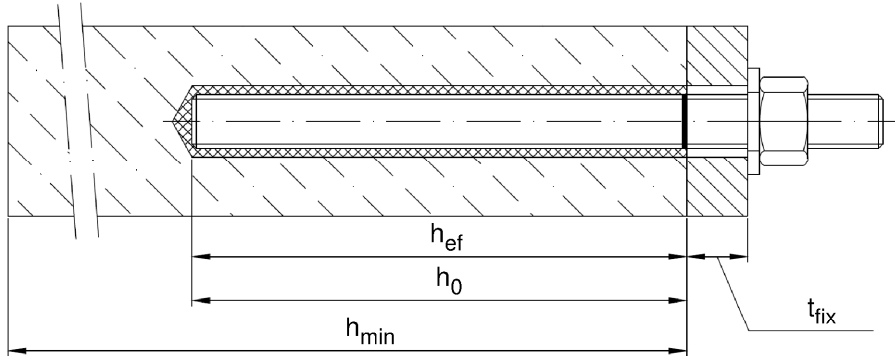

Installation reinforcing bar $\varnothing 8$ up to $\varnothing 32$

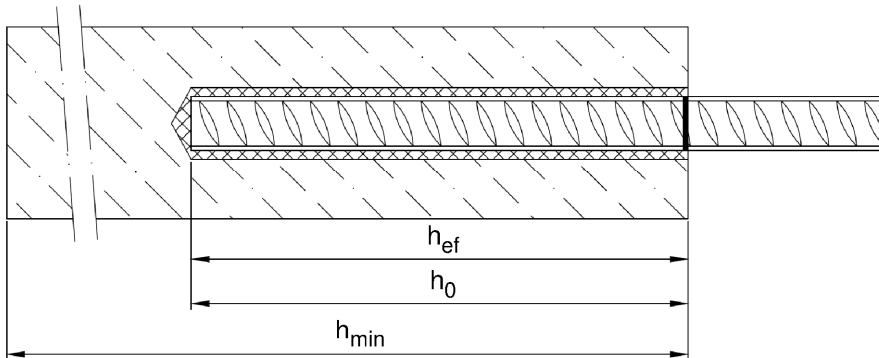

Installation internal threaded anchor rod IG-M6 up to IG-M20

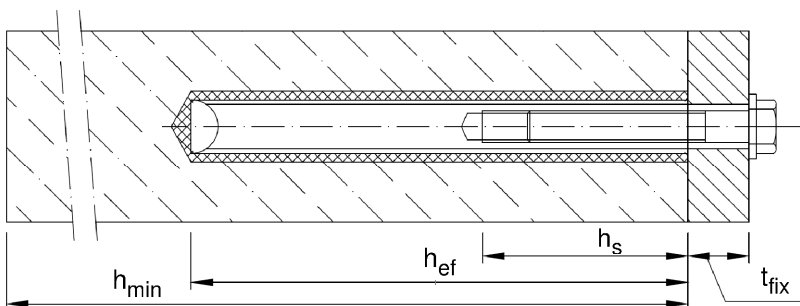

- t_{fix} = thickness of fixture
- h_{ef} = effective anchorage depth
- h_0 = depth of drill hole
- h_{min} = minimum thickness of member

TILCA® TIM U-H Injection System for concrete

Product description
Installed condition

Annex A 1

Cartridge: TILCA TIM U-H

150 ml, 280 ml, 300 ml up to 333 ml and 380 ml up to 420 ml cartridge (Type: coaxial)

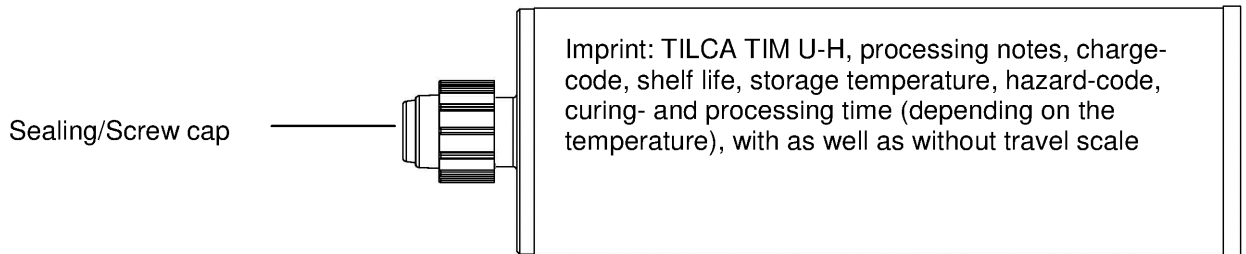

235 ml, 345 ml up to 360 ml and 825 ml cartridge (Type: "side-by-side")

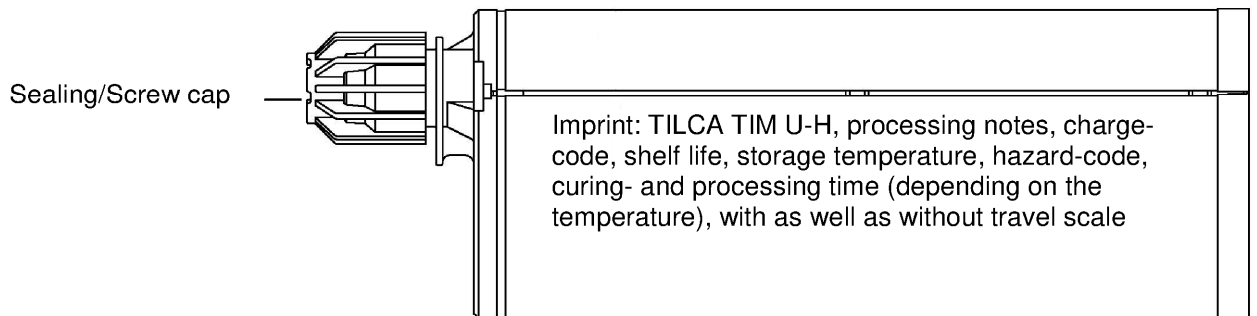

Static Mixer

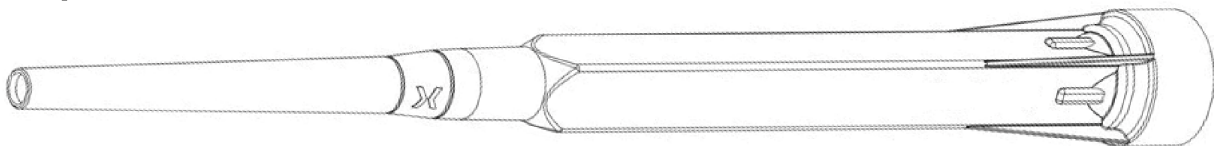

Piston plug and mixer extension

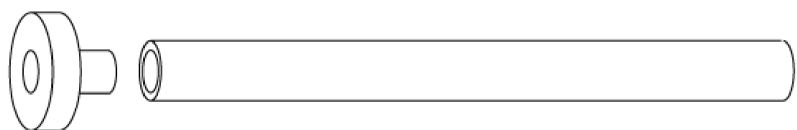

TILCA® TIM U-H Injection System for concrete

Product description
Injection system

Annex A 2

Threaded rod M8, M10, M12, M16, M20, M24, M27, M30 with washer and hexagon nut

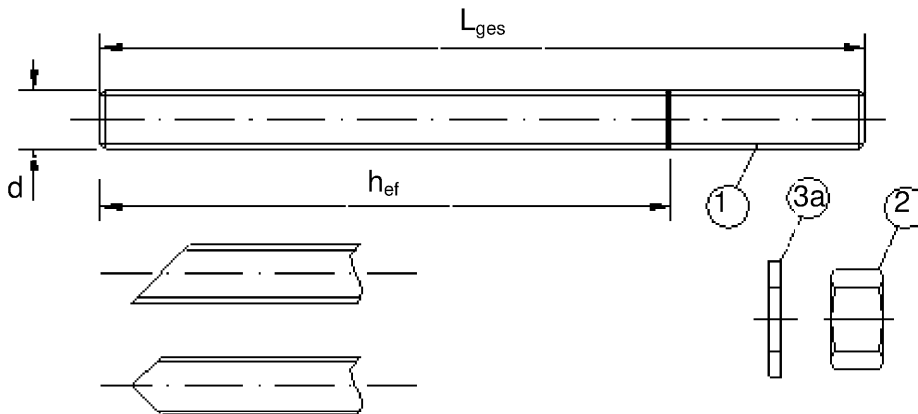

Commercial standard threaded rod with:



- Materials, dimensions and mechanical properties acc. Table A1
- Inspection certificate 3.1 acc. to EN 10204:2004
- Marking of embedment depth

Internal threaded anchor rod IG-M6, IG-M8, IG-M10, IG-M12, IG-M16, IG-M20

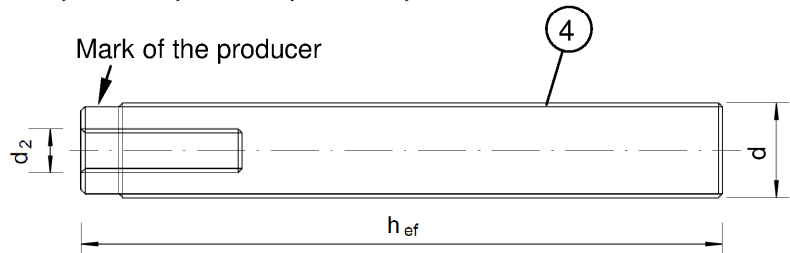
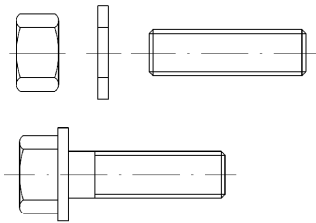
Threaded rod or screw



Marking: e.g.  M8

 Marking Internal thread
 Mark

M8 Thread size (Internal thread)
A4 additional mark for stainless steel
HCR additional mark for high-corrosion resistance steel

Filling washer and mixer reduction nozzle for filling the annular gap between anchor rod and fixture

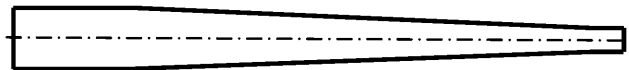
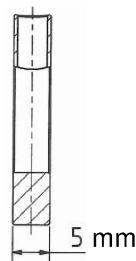
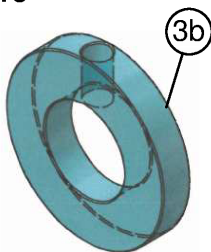

TILCA® TIM U-H Injection System for concrete

Product description

Threaded rod, internal threaded rod and filling washer

Annex A 3

Table A1: Materials						
Part	Designation	Material				
Steel, zinc plated (Steel acc. to EN 10087:1998 or EN 10263:2001)						
- zinc plated $\geq 5 \mu\text{m}$ acc. to EN ISO 4042:1999 or						
- hot-dip galvanised $\geq 40 \mu\text{m}$ acc. to EN ISO 1461:2009 and EN ISO 10684:2004+AC:2009 or						
- sherardized $\geq 45 \mu\text{m}$ acc. to EN ISO 17668:2016						
1	Threaded rod	Property class	Characteristic tensile strength	Characteristic yield strength	Elongation at fracture	
		acc. to EN ISO 898-1:2013	4.6	$f_{uk} = 400 \text{ N/mm}^2$	$f_{yk} = 240 \text{ N/mm}^2$	$A_5 > 8\%$
			4.8	$f_{uk} = 400 \text{ N/mm}^2$	$f_{yk} = 320 \text{ N/mm}^2$	$A_5 > 8\%$
			5.6	$f_{uk} = 500 \text{ N/mm}^2$	$f_{yk} = 300 \text{ N/mm}^2$	$A_5 > 8\%$
			5.8	$f_{uk} = 500 \text{ N/mm}^2$	$f_{yk} = 400 \text{ N/mm}^2$	$A_5 > 8\%$
8.8	$f_{uk} = 800 \text{ N/mm}^2$	$f_{yk} = 640 \text{ N/mm}^2$	$A_5 \geq 12\%$ ³⁾			
2	Hexagon nut	acc. to EN ISO 898-2:2012	4	for threaded rod class 4.6 or 4.8		
			5	for threaded rod class 5.6 or 5.8		
			8	for threaded rod class 8.8		
3a	Washer	Steel, zinc plated, hot-dip galvanised or sherardized (e.g.: EN ISO 887:2006, EN ISO 7089:2000, EN ISO 7093:2000 or EN ISO 7094:2000)				
3b	Filling washer	Steel, zinc plated, hot-dip galvanised or sherardized				
4	Internal threaded anchor rod	Property class	Characteristic tensile strength	Characteristic yield strength	Elongation at fracture	
		acc. to EN ISO 898-1:2013	5.8	$f_{uk} = 500 \text{ N/mm}^2$	$f_{yk} = 400 \text{ N/mm}^2$	$A_5 > 8\%$
			8.8	$f_{uk} = 800 \text{ N/mm}^2$	$f_{yk} = 640 \text{ N/mm}^2$	$A_5 > 8\%$
Stainless steel A2 (Material 1.4301 / 1.4303 / 1.4307 / 1.4567 or 1.4541, acc. to EN 10088-1:2014)						
Stainless steel A4 (Material 1.4401 / 1.4404 / 1.4571 / 1.4362 or 1.4578, acc. to EN 10088-1:2014)						
High corrosion resistance steel (Material 1.4529 or 1.4565, acc. to EN 10088-1: 2014)						
1	Threaded rod ¹⁾⁴⁾	Property class	Characteristic tensile strength	Characteristic yield strength	Elongation at fracture	
		acc. to EN ISO 3506-1:2009	50	$f_{uk} = 500 \text{ N/mm}^2$	$f_{yk} = 210 \text{ N/mm}^2$	$A_5 \geq 12\%$ ³⁾
			70	$f_{uk} = 700 \text{ N/mm}^2$	$f_{yk} = 450 \text{ N/mm}^2$	$A_5 \geq 12\%$ ³⁾
80	$f_{uk} = 800 \text{ N/mm}^2$	$f_{yk} = 600 \text{ N/mm}^2$	$A_5 \geq 12\%$ ³⁾			
2	Hexagon nut ¹⁾⁴⁾	acc. to EN ISO 3506-1:2009	50	for threaded rod class 50		
			70	for threaded rod class 70		
			80	for threaded rod class 80		
3a	Washer	A2: Material 1.4301 / 1.4303 / 1.4307 / 1.4567 or 1.4541, acc. to EN 10088-1:2014 A4: Material 1.4401 / 1.4404 / 1.4571 / 1.4362 or 1.4578, acc. to EN 10088-1:2014 HCR: Material 1.4529 or 1.4565, acc. to EN 10088-1: 2014 (e.g.: EN ISO 887:2006, EN ISO 7089:2000, EN ISO 7093:2000 or EN ISO 7094:2000)				
3b	Filling washer	Stainless steel A4, High corrosion resistance steel				
4	Internal threaded anchor rod ¹⁾²⁾	Property class	Characteristic tensile strength	Characteristic yield strength	Elongation at fracture	
		acc. to EN ISO 3506-1:2009	50	$f_{uk} = 500 \text{ N/mm}^2$	$f_{yk} = 210 \text{ N/mm}^2$	$A_5 > 8\%$
			70	$f_{uk} = 700 \text{ N/mm}^2$	$f_{yk} = 450 \text{ N/mm}^2$	$A_5 > 8\%$
¹⁾ Property class 70 for threaded rods up to M24 and Internal threaded anchor rods up to IG-M16, ²⁾ for IG-M20 only property class 50 ³⁾ $A_5 > 8\%$ fracture elongation if <u>no</u> requirement for performance category C2 exists ⁴⁾ Property class 80 only for stainless steel A4						
TILCA® TIM U-H Injection System for concrete					Annex A 4	
Product description Materials threaded rod and internal threaded rod						

Reinforcing bar $\varnothing 8, \varnothing 10, \varnothing 12, \varnothing 14, \varnothing 16, \varnothing 20, \varnothing 24, \varnothing 25, \varnothing 28, \varnothing 32$

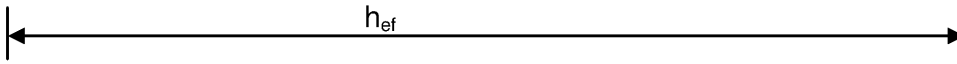
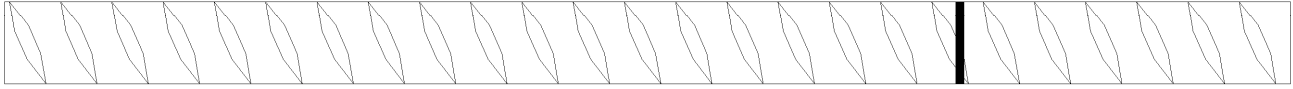

- Minimum value of related rip area $f_{R,min}$ according to EN 1992-1-1:2004+AC:2010
- Rib height of the bar shall be in the range $0,05d \leq h \leq 0,07d$
(d: Nominal diameter of the bar; h: Rip height of the bar)

Table A2: Materials

Part	Designation	Material
Reinforcing bars		
1	Rebar EN 1992-1-1:2004+AC:2010, Annex C	Bars and de-coiled rods class B or C f_{yk} and k according to NDP or NCL of EN 1992-1-1/NA $f_{uk} = f_{tk} = k \cdot f_{yk}$

TILCA® TIM U-H Injection System for concrete

Product description
Materials reinforcing bar

Annex A 5

Specifications of intended use

Anchorage subject to:

- Static and quasi-static loads: M8 to M30, Rebar Ø8 to Ø32, IG-M6 to IG-M20.
- Seismic action for Performance Category C1: M8 to M30 (except hot-dip galvanised rods), Rebar Ø8 to Ø32.
- Seismic action for Performance Category C2: M12 to M24 (except hot-dip galvanised rods).

Base materials:

- Compacted reinforced or unreinforced normal weight concrete without fibres according to EN 206:2013.
- Strength classes C20/25 to C50/60 according to EN 206:2013.
- Non-cracked concrete: M8 to M30, Rebar Ø8 to Ø32, IG-M6 to IG-M20.
- Cracked concrete: M8 to M30, Rebar Ø8 to Ø32, IG-M6 to IG-M20.

Temperature Range:

- I: - 40 °C to +80 °C (max long term temperature +50 °C and max short term temperature +80 °C)
- II: - 40 °C to +120 °C (max long term temperature +72 °C and max short term temperature +120 °C)
- III: - 40 °C to +160 °C (max long term temperature +100 °C and max short term temperature +160 °C)

Use conditions (Environmental conditions):

- Structures subject to dry internal conditions (zinc coated steel, stainless steel A2 resp. A4 or high corrosion resistant steel).
- Structures subject to external atmospheric exposure (including industrial and marine environment) and to permanently damp internal condition, if no particular aggressive conditions exist (stainless steel A4 or high corrosion resistant steel).
- Structures subject to external atmospheric exposure and to permanently damp internal condition, if other particular aggressive conditions exist (high corrosion resistant steel).

Note: Particular aggressive conditions are e.g. permanent, alternating immersion in seawater or the splash zone of seawater, chloride atmosphere of indoor swimming pools or atmosphere with extreme chemical pollution (e.g. in desulphurization plants or road tunnels where de-icing materials are used).

Design:

- Verifiable calculation notes and drawings are prepared taking account of the loads to be anchored. The position of the anchor is indicated on the design drawings (e. g. position of the anchor relative to reinforcement or to supports, etc.).
- Anchorages are designed under the responsibility of an engineer experienced in anchorages and concrete work.
- The anchorages are designed in accordance to EN 1992-4:2018 and Technical Report TR 055

Installation:

- Dry, wet concrete or flooded bore holes (not sea-water).
- Hole drilling by hammer (HD), hollow (HDB) or compressed air drill mode (CD).
- Overhead installation allowed.
- Anchor installation carried out by appropriately qualified personnel and under the supervision of the person responsible for technical matters of the site.

TILCA® TIM U-H Injection System for concrete

Intended Use
Specifications

Annex B 1

Table B1: Installation parameters for threaded rod

Anchor size			M 8	M 10	M 12	M 16	M 20	M 24	M 27	M 30
Diameter of element	$d = d_{nom}$	[mm]	8	10	12	16	20	24	27	30
Nominal drill hole diameter	d_0	[mm]	10	12	14	18	22	28	30	35
Effective embedment depth	$h_{ef,min}$	[mm]	60	60	70	80	90	96	108	120
	$h_{ef,max}$	[mm]	160	200	240	320	400	480	540	600
Diameter of clearance hole in the fixture ¹⁾	Prepositioned installation d_f	[mm]	9	12	14	18	22	26	30	33
	Push through installation d_f	[mm]	12	14	16	20	24	30	33	40
Maximum torque moment	$T_{inst} \leq$	[Nm]	10	20	40 ²⁾	60	100	170	250	300
Minimum thickness of member	h_{min}	[mm]	$h_{ef} + 30 \text{ mm}$ $\geq 100 \text{ mm}$			$h_{ef} + 2d_0$				
Minimum spacing	s_{min}	[mm]	40	50	60	75	95	115	125	140
Minimum edge distance	c_{min}	[mm]	35	40	45	50	60	65	75	80

¹⁾ For application under seismic loading the diameter of clearance hole in the fixture shall be at maximum $d_f + 1 \text{ mm}$ or alternatively the annular gap between fixture and threaded rod shall be filled force-fit with mortar.

²⁾ Maximum Torque moment for M12 with steel Grade 4.6 is 35 Nm

Table B2: Installation parameters for rebar

Rebar size			Ø 8	Ø 10	Ø 12	Ø 14	Ø 16	Ø 20	Ø 24	Ø 25	Ø 28	Ø 32
Diameter of element	$d = d_{nom}$	[mm]	8	10	12	14	16	20	24	25	28	32
Nominal drill hole diameter	d_0	[mm]	12	14	16	18	20	25	32	32	35	40
Effective embedment depth	$h_{ef,min}$	[mm]	60	60	70	75	80	90	96	100	112	128
	$h_{ef,max}$	[mm]	160	200	240	280	320	400	480	500	560	640
Minimum thickness of member	h_{min}	[mm]	$h_{ef} + 30 \text{ mm}$ $\geq 100 \text{ mm}$			$h_{ef} + 2d_0$						
Minimum spacing	s_{min}	[mm]	40	50	60	70	75	95	120	120	130	150
Minimum edge distance	c_{min}	[mm]	35	40	45	50	50	60	70	70	75	85

Table B3: Installation parameters for Internal threaded rod

Anchor size			IG-M 6	IG-M 8	IG-M 10	IG-M 12	IG-M 16	IG-M 20
Internal diameter of sleeve	d_2	[mm]	6	8	10	12	16	20
Outer diameter of sleeve ¹⁾	$d = d_{nom}$	[mm]	10	12	16	20	24	30
Nominal drill hole diameter	d_0	[mm]	12	14	18	22	28	35
Effective embedment depth	$h_{ef,min}$	[mm]	60	70	80	90	96	120
	$h_{ef,max}$	[mm]	200	240	320	400	480	600
Diameter of clearance hole in the fixture	d_f	[mm]	7	9	12	14	18	22
Maximum torque moment	$T_{inst} \leq$	[Nm]	10	10	20	40	60	100
Thread engagement length min/max	l_{IG}	[mm]	8/20	8/20	10/25	12/30	16/32	20/40
Minimum thickness of member	h_{min}	[mm]	$h_{ef} + 30 \text{ mm}$ $\geq 100 \text{ mm}$			$h_{ef} + 2d_0$		
Minimum spacing	s_{min}	[mm]	50	60	75	95	115	140
Minimum edge distance	c_{min}	[mm]	40	45	50	60	65	80

¹⁾ With metric threads according to EN 1993-1-8:2005+AC:2009

TILCA® TIM U-H Injection System for concrete

Intended Use
Installation parameters

Annex B 2

Table B4: Parameter cleaning and setting tools

Threaded Rod	Rebar	Internal threaded rod	d_0 Drill bit - Ø HD, HDB, CA	d_b Brush - Ø		$d_{b,min}$ min. Brush - Ø	Piston plug	Installation direction and use of piston plug		
				[mm]	[mm]			[mm]	↓	→
M8			10	RB10	11,5	10,5	No plug required			
M10	8	IG-M6	12	RB12	13,5	12,5				
M12	10	IG-M8	14	RB14	15,5	14,5				
	12		16	RB16	17,5	16,5				
M16	14	IG-M10	18	RB18	20,0	18,5	IA18	$h_{ef} > 250$ mm	$h_{ef} > 250$ mm	all
	16		20	RB20	22,0	20,5	IA20			
M20		IG-M12	22	RB22	24,0	22,5	IA22			
	20		25	RB25	27,0	25,5	IA25			
M24		IG-M16	28	RB28	30,0	28,5	IA28			
M27			30	RB30	31,8	30,5	IA30			
	24 / 25		32	RB32	34,0	32,5	IA32			
M30	28	IG-M20	35	RB35	37,0	35,5	IA35			
	32		40	RB40	43,5	40,5	IA40			



MAC - Hand pump (volume 750 ml)
Drill bit diameter (d_0): 10 mm to 20 mm
Drill hole depth (h_0): $< 10 d_s$
Only in non-cracked concrete



CAC - Rec. compressed air tool (min 6 bar)
Drill bit diameter (d_0): all diameters



HDB – Hollow drill bit system
Drill bit diameter (d_0): all diameters

The hollow drill bit system contains the Heller Duster Expert hollow drill bit and a class M vacuum with minimum negative pressure of 230 hPa and flow rate of minimum 61 l/s.

TILCA® TIM U-H Injection System for concrete

Intended Use
Cleaning and setting tools

Annex B 3

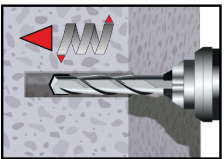
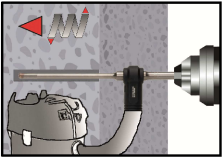
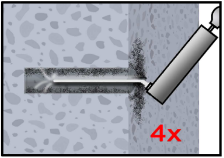
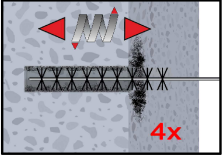
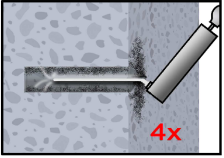
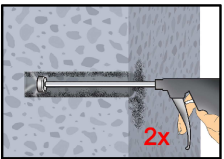
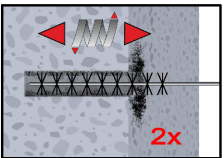
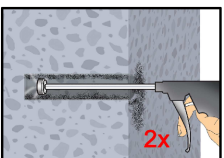
Installation instructions	
Drilling of the bore hole	
	<p>1a. Hammer (HD) or compressed air drilling (CD) Drill a hole into the base material to the size and embedment depth required by the selected anchor (Table B1, B2, or B3). Proceed with Step 2. In case of aborted drill hole, the drill hole shall be filled with mortar.</p>
	<p>1b. Hollow drill bit system (HDB) (see Annex B 3) Drill a hole into the base material to the size and embedment depth required by the selected anchor (Table B1, B2, or B3). This drilling system removes the dust and cleans the bore hole during drilling (all conditions). Proceed with Step 3. In case of aborted drill hole, the drill hole shall be filled with mortar.</p>
Attention! Standing water in the bore hole must be removed before cleaning.	
MAC: Cleaning for dry and wet bore holes with diameter $d_0 \leq 20\text{mm}$ and bore hole depth $h_0 \leq 10d_{\text{nom}}$ (uncracked concrete only!)	
	<p>2a. Starting from the bottom or back of the bore hole, blow the hole clean by a hand pump (Annex B 3) a minimum of four times.</p>
	<p>2b. Check brush diameter (Table B4). Brush the hole with an appropriate sized wire brush $> d_{b,\text{min}}$ (Table B4) a minimum of four times in a twisting motion. If the bore hole ground is not reached with the brush, a brush extension must be used.</p>
	<p>2c. Finally blow the hole clean again with a hand pump (Annex B 3) a minimum of four times.</p>
CAC: Cleaning for dry, wet and water-filled bore holes with all diameter in uncracked and cracked concrete	
	<p>2a. Starting from the bottom or back of the bore hole, blow the hole clean with compressed air (min. 6 bar) (Annex B 3) a minimum of two times until return air stream is free of noticeable dust. If the bore hole ground is not reached an extension must be used.</p>
	<p>2b. Check brush diameter (Table B4). Brush the hole with an appropriate sized wire brush $> d_{b,\text{min}}$ (Table B4) a minimum of two times in a twisting motion. If the bore hole ground is not reached with the brush, a brush extension must be used.</p>
	<p>2c. Finally blow the hole clean again with compressed air (min. 6 bar) (Annex B 3) a minimum of two times until return air stream is free of noticeable dust. If the bore hole ground is not reached an extension must be used.</p>
<p>After cleaning, the bore hole has to be protected against re-contamination in an appropriate way, until dispensing the mortar in the bore hole. If necessary, the cleaning has to be repeated directly before dispensing the mortar. In-flowing water must not contaminate the bore hole again.</p>	
<p>TILCA® TIM U-H Injection System for concrete</p>	
<p>Intended Use Installation instructions</p>	<p>Annex B 4</p>

Installation instructions (continuation)	
  	<p>3. Attach the supplied static-mixing nozzle to the cartridge and load the cartridge into the correct dispensing tool. For every working interruption longer than the recommended working time (Table B5) as well as for new cartridges, a new static-mixer shall be used.</p> <p>4. Prior to inserting the anchor rod into the filled bore hole, the position of the embedment depth shall be marked on the anchor rods.</p> <p>5. Prior to dispensing into the anchor hole, squeeze out separately a minimum of three full strokes and discard non-uniformly mixed adhesive components until the mortar shows a consistent grey colour.</p>
     	<p>6. Starting from the bottom or back of the cleaned anchor hole, fill the hole up to approximately two-thirds with adhesive. Slowly withdraw the static mixing nozzle as the hole fills to avoid creating air pockets. If the bottom or back of the anchor hole is not reached, an appropriate extension nozzle must be used. Observe the gel-/ working times given in Table B5.</p> <p>7. Piston plugs and mixer nozzle extensions shall be used according to Table B4 for the following applications:</p> <ul style="list-style-type: none"> • Horizontal assembly (horizontal direction) and ground erection (vertical downwards direction): Drill bit-$\varnothing d_0 \geq 18$ mm and embedment depth $h_{ef} > 250$mm • Overhead assembly (vertical upwards direction): Drill bit-$\varnothing d_0 \geq 18$ mm <p>8. Push the threaded rod or reinforcing bar into the anchor hole while turning slightly to ensure positive distribution of the adhesive until the embedment depth is reached. The anchor shall be free of dirt, grease, oil or other foreign material.</p> <p>9. After inserting the anchor, the annular gap between anchor rod and concrete, in case of a push through installation additionally also the fixture, must be completely filled with mortar. If excess mortar is not visible at the top of the hole, the requirement is not fulfilled and the application has to be renewed. For overhead application the anchor rod shall be fixed (e.g. wedges).</p> <p>10. Allow the adhesive to cure to the specified time prior to applying any load or torque. Do not move or load the anchor until it is fully cured (attend Table B5).</p> <p>11. After full curing, the add-on part can be installed with up to the max. torque (Table B1 or B3) by using a calibrated torque wrench. In case of prepositioned installation the annular gap between anchor and fixture can be optionally filled with mortar. Therefore substitute the washer by the filling washer and connect the mixer reduction nozzle to the tip of the mixer. The annular gap is filled with mortar, when mortar oozes out of the washer.</p>
<p>TILCA® TIM U-H Injection System for concrete</p>	
<p>Intended Use Installation instructions (continuation)</p>	<p>Annex B 5</p>

Table B5: Maximum working time and minimum curing time

Concrete temperature	Gelling working time	Minimum curing time in dry concrete	Minimum curing time in wet concrete
- 5 °C to - 1 °C	50 min	5 h	10 h
0 °C to + 4 °C	25 min	3,5 h	7 h
+ 5 °C to + 9 °C	15 min	2 h	4 h
+ 10 °C to + 14 °C	10 min	1 h	2 h
+ 15 °C to + 19 °C	6 min	40 min	80 min
+ 20 °C to + 29 °C	3 min	30 min	60 min
+ 30 °C to + 40 °C	2 min	30 min	60 min
Cartridge temperature	+5°C to +40°C		

TILCA® TIM U-H Injection System for concrete

Intended Use
Curing time

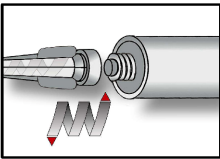
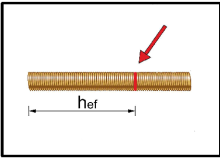
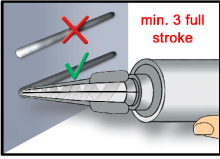
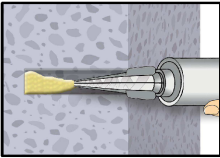
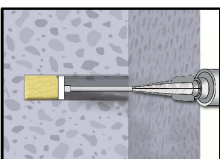
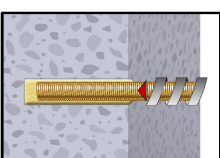
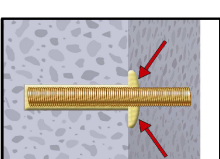
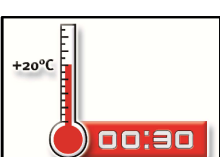
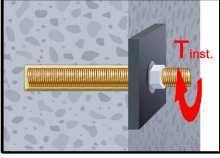
Annex B 6

Table C1: Characteristic values for steel tension resistance and steel shear resistance of threaded rods

Size			M 8	M 10	M 12	M 16	M 20	M24	M 27	M 30	
Cross section area	A_s	[mm ²]	36,6	58	84,3	157	245	353	459	561	
Characteristic tension resistance, Steel failure ¹⁾											
Steel, Property class 4.6 and 4.8	$N_{Rk,s}$	[kN]	15 (13)	23 (21)	34	63	98	141	184	224	
Steel, Property class 5.6 and 5.8	$N_{Rk,s}$	[kN]	18 (17)	29 (27)	42	78	122	176	230	280	
Steel, Property class 8.8	$N_{Rk,s}$	[kN]	29 (27)	46 (43)	67	125	196	282	368	449	
Stainless steel A2, A4 and HCR, class 50	$N_{Rk,s}$	[kN]	18	29	42	79	123	177	230	281	
Stainless steel A2, A4 and HCR, class 70	$N_{Rk,s}$	[kN]	26	41	59	110	171	247	-	-	
Stainless steel A4 and HCR, class 80	$N_{Rk,s}$	[kN]	29	46	67	126	196	282	-	-	
Characteristic tension resistance, Partial factor ²⁾											
Steel, Property class 4.6 and 5.6	$\gamma_{Ms,N}$	[-]	2,0								
Steel, Property class 4.8, 5.8 and 8.8	$\gamma_{Ms,N}$	[-]	1,5								
Stainless steel A2, A4 and HCR, class 50	$\gamma_{Ms,N}$	[-]	2,86								
Stainless steel A2, A4 and HCR, class 70	$\gamma_{Ms,N}$	[-]	1,87								
Stainless steel A4 and HCR, class 80	$\gamma_{Ms,N}$	[-]	1,6								
Characteristic shear resistance, Steel failure ¹⁾											
Without lever arm	Steel, Property class 4.6 and 4.8	$V^0_{Rk,s}$	[kN]	9 (8)	14 (13)	20	38	59	85	110	135
	Steel, Property class 5.6 and 5.8	$V^0_{Rk,s}$	[kN]	9 (8)	15 (13)	21	39	61	88	115	140
	Steel, Property class 8.8	$V^0_{Rk,s}$	[kN]	15 (13)	23 (21)	34	63	98	141	184	224
	Stainless steel A2, A4 and HCR, class 50	$V^0_{Rk,s}$	[kN]	9	15	21	39	61	88	115	140
	Stainless steel A2, A4 and HCR, class 70	$V^0_{Rk,s}$	[kN]	13	20	30	55	86	124	-	-
	Stainless steel A4 and HCR, class 80	$V^0_{Rk,s}$	[kN]	15	23	34	63	98	141	-	-
With lever arm	Steel, Property class 4.6 and 4.8	$M^0_{Rk,s}$	[Nm]	15 (13)	30 (27)	52	133	260	449	666	900
	Steel, Property class 5.6 and 5.8	$M^0_{Rk,s}$	[Nm]	19 (16)	37 (33)	65	166	324	560	833	1123
	Steel, Property class 8.8	$M^0_{Rk,s}$	[Nm]	30 (26)	60 (53)	105	266	519	896	1333	1797
	Stainless steel A2, A4 and HCR, class 50	$M^0_{Rk,s}$	[Nm]	19	37	66	167	325	561	832	1125
	Stainless steel A2, A4 and HCR, class 70	$M^0_{Rk,s}$	[Nm]	26	52	92	232	454	784	-	-
	Stainless steel A4 and HCR, class 80	$M^0_{Rk,s}$	[Nm]	30	59	105	266	519	896	-	-
Characteristic shear resistance, Partial factor ²⁾											
Steel, Property class 4.6 and 5.6	$\gamma_{Ms,V}$	[-]	1,67								
Steel, Property class 4.8, 5.8 and 8.8	$\gamma_{Ms,V}$	[-]	1,25								
Stainless steel A2, A4 and HCR, class 50	$\gamma_{Ms,V}$	[-]	2,38								
Stainless steel A2, A4 and HCR, class 70	$\gamma_{Ms,V}$	[-]	1,56								
Stainless steel A4 and HCR, class 80	$\gamma_{Ms,V}$	[-]	1,33								
¹⁾ Values are only valid for the given stress area A_s . Values in brackets are valid for undersized threaded rods with smaller stress area A_s for hot-dip galvanised threaded rods according to EN ISO 10684:2004+AC:2009. ²⁾ in absence of national regulation											
TILCA® TIM U-H Injection System for concrete									Annex C 1		
Performances Characteristic values for steel tension resistance and steel shear resistance of threaded rods											

Table C2: Characteristic values of tension loads under static and quasi-static action				M 8	M 10	M 12	M 16	M 20	M 24	M 27	M 30	
Anchor size threaded rod												
Steel failure												
Characteristic tension resistance		$N_{Rk,s}$	[kN]	$A_s \cdot f_{uk}$ (or see Table C1)								
Partial factor		$\gamma_{Ms,N}$	[-]	see Table C1								
Combined pull-out and concrete failure												
Characteristic bond resistance in non-cracked concrete C20/25												
Temperature range	I: 80°C/50°C	Dry, wet concrete and flooded bore hole	$\tau_{Rk,ucr}$	[N/mm ²]	17	17	16	15	14	13	13	13
	II: 120°C/72°C		$\tau_{Rk,ucr}$	[N/mm ²]	15	14	14	13	12	12	11	11
	III: 160°C/100°C		$\tau_{Rk,ucr}$	[N/mm ²]	12	11	11	10	9,5	9,0	9,0	9,0
Characteristic bond resistance in cracked concrete C20/25												
Temperature range	I: 80°C/50°C	Dry, wet concrete and flooded bore hole	$\tau_{Rk,cr}$	[N/mm ²]	7,0	7,5	8,0	9,0	8,5	7,0	7,0	7,0
	II: 120°C/72°C		$\tau_{Rk,cr}$	[N/mm ²]	6,0	6,5	7,0	7,5	7,0	6,0	6,0	6,0
	III: 160°C/100°C		$\tau_{Rk,cr}$	[N/mm ²]	5,5	5,5	6,0	6,5	6,0	5,5	5,5	5,5
Increasing factors for concrete Ψ_c				C25/30	1,02							
				C30/37	1,04							
				C35/45	1,07							
				C40/50	1,08							
				C45/55	1,09							
				C50/60	1,10							
Concrete cone failure												
Non-cracked concrete		$k_{ucr,N}$	[-]	11,0								
Cracked concrete		$k_{cr,N}$	[-]	7,7								
Edge distance		$c_{cr,N}$	[mm]	1,5 h_{ef}								
Axial distance		$s_{cr,N}$	[mm]	2 $c_{cr,N}$								
Splitting												
Edge distance	$h/h_{ef} \geq 2,0$	$c_{cr,sp}$	[mm]	1,0 h_{ef}								
	$2,0 > h/h_{ef} > 1,3$			$2 \cdot h_{ef} \left(2,5 - \frac{h}{h_{ef}} \right)$								
	$h/h_{ef} \leq 1,3$			2,4 h_{ef}								
Axial distance		$s_{cr,sp}$	[mm]	2 $c_{cr,sp}$								
Installation factor												
for dry and wet concrete	MAC	γ_{inst}	[-]	1,2				NPA				
	CAC			1,0								
	HDB			1,2								
for flooded bore hole	CAC			1,4								
TILCA® TIM U-H Injection System for concrete										Annex C 2		
Performances Characteristic values of tension loads under static and quasi-static action												

Table C3: Characteristic values of shear loads under static and quasi-static action											
Anchor size threaded rod			M 8	M 10	M 12	M 16	M 20	M24	M 27	M 30	
Steel failure without lever arm											
Characteristic shear resistance Steel, strength class 4.6 and 4.8	$V_{Rk,s}^0$	[kN]	0,6 · A _s · f _{uk} (or see Table C1)								
Characteristic shear resistance Steel, strength class 5.6, 5.8 and 8.8 Stainless Steel A2, A4 and HCR, all classes	$V_{Rk,s}^0$	[kN]	0,5 · A _s · f _{uk} (or see Table C1)								
Partial factor	$\gamma_{Ms,V}$	[-]	see Table C1								
Ductility factor	k ₇	[-]	1,0								
Steel failure with lever arm											
Characteristic bending moment	$M_{Rk,s}^0$	[Nm]	1,2 · W _{el} · f _{uk} (or see Table C1)								
Elastic section modulus	W _{el}	[mm ³]	31	62	109	277	541	935	1387	1874	
Partial factor	$\gamma_{Ms,V}$	[-]	see Table C1								
Concrete pry-out failure											
Factor	k ₈	[-]	2,0								
Installation factor	γ_{inst}	[-]	1,0								
Concrete edge failure											
Effective length of fastener	l _f	[mm]	min(h _{ef} ; 12 · d _{nom})						min(h _{ef} ; 300mm)		
Outside diameter of fastener	d _{nom}	[mm]	8	10	12	16	20	24	27	30	
Installation factor	γ_{inst}	[-]	1,0								
TILCA® TIM U-H Injection System for concrete									Annex C 3		
Performances Characteristic values of shear loads under static and quasi-static action											

Table C4: Characteristic values of tension loads under static and quasi-static action				IG-M 6	IG-M 8	IG-M 10	IG-M 12	IG-M 16	IG-M 20	
Anchor size internal threaded anchor rods										
Steel failure¹⁾										
Characteristic tension resistance,	5.8	$N_{Rk,s}$	[kN]	10	17	29	42	76	123	
Steel, strength class	8.8	$N_{Rk,s}$	[kN]	16	27	46	67	121	196	
Partial factor, strength class 5.8 and 8.8		$\gamma_{Ms,N}$	[-]	1,5						
Characteristic tension resistance, Stainless Steel A4 and HCR, Strength class 70 ²⁾		$N_{Rk,s}$	[kN]	14	26	41	59	110	124	
Partial factor		$\gamma_{Ms,N}$	[-]	1,87					2,86	
Combined pull-out and concrete cone failure										
Characteristic bond resistance in non-cracked concrete C20/25										
Temperature range	I: 80°C/50°C	Dry, wet concrete and flooded bore hole	$\tau_{Rk,ucr}$	[N/mm ²]	17	16	15	14	13	13
	II: 120°C/72°C		$\tau_{Rk,ucr}$	[N/mm ²]	14	14	13	12	12	11
	III: 160°C/100°C		$\tau_{Rk,ucr}$	[N/mm ²]	11	11	10	9,5	9,0	9,0
Characteristic bond resistance in cracked concrete C20/25										
Temperature range	I: 80°C/50°C	Dry, wet concrete and flooded bore hole	$\tau_{Rk,cr}$	[N/mm ²]	7,5	8,0	9,0	8,5	7,0	7,0
	II: 120°C/72°C		$\tau_{Rk,cr}$	[N/mm ²]	6,5	7,0	7,5	7,0	6,0	6,0
	III: 160°C/100°C		$\tau_{Rk,cr}$	[N/mm ²]	5,5	6,0	6,5	6,0	5,5	5,5
Increasing factors for concrete ψ_c	C25/30			1,02						
	C30/37			1,04						
	C35/45			1,07						
	C40/50			1,08						
	C45/55			1,09						
C50/60			1,10							
Concrete cone failure										
Non-cracked concrete			$k_{ucr,N}$	[-]	11,0					
Cracked concrete			$k_{cr,N}$	[-]	7,7					
Edge distance			$c_{cr,N}$	[mm]	1,5 h_{ef}					
Axial distance			$s_{cr,N}$	[mm]	2 $c_{cr,N}$					
Splitting failure										
Edge distance	$h/h_{ef} \geq 2,0$	$c_{cr,sp}$	[mm]	1,0 h_{ef}						
	$2,0 > h/h_{ef} > 1,3$			$2 \cdot h_{ef} \left(2,5 - \frac{h}{h_{ef}} \right)$						
	$h/h_{ef} \leq 1,3$			2,4 h_{ef}						
Axial distance			$s_{cr,sp}$	[mm]	2 $c_{cr,sp}$					
Installation factor										
for dry and wet concrete	MAC	γ_{inst}	[-]	1,2			NPA			
	CAC			1,0						
	HDB			1,2						
for flooded bore hole	CAC	1,4								
¹⁾ Fastenings (incl. nut and washer) must comply with the appropriate material and property class of the internal threaded rod. The characteristic tension resistance for steel failure is valid for the internal threaded rod and the fastening element.										
²⁾ For IG-M20 strength class 50 is valid										
TILCA® TIM U-H Injection System for concrete									Annex C 4	
Performances Characteristic values of tension loads under static and quasi-static action										

Table C5: Characteristic values of shear loads under static and quasi-static action									
Anchor size for internal threaded anchor rods				IG-M 6	IG-M 8	IG-M 10	IG-M 12	IG-M 16	IG-M 20
Steel failure without lever arm¹⁾									
Characteristic shear resistance, Steel, strength class	5.8	$V_{Rk,s}^0$	[kN]	5	9	15	21	38	61
	8.8	$V_{Rk,s}^0$	[kN]	8	14	23	34	60	98
Partial factor, strength class 5.8 and 8.8	$\gamma_{Ms,V}$		[-]	1,25					
Characteristic shear resistance, Stainless Steel A4 and HCR, Strength class 70 ²⁾		$V_{Rk,s}^0$	[kN]	7	13	20	30	55	40
	Partial factor	$\gamma_{Ms,V}$	[-]	1,56					2,38
Ductility factor	k_7		[-]	1,0					
Steel failure with lever arm¹⁾									
Characteristic bending moment, Steel, strength class	5.8	$M_{Rk,s}^0$	[Nm]	8	19	37	66	167	325
	8.8	$M_{Rk,s}^0$	[Nm]	12	30	60	105	267	519
Partial factor, strength class 5.8 and 8.8	$\gamma_{Ms,V}$		[-]	1,25					
Characteristic bending moment, Stainless Steel A4 and HCR, Strength class 70 ²⁾		$M_{Rk,s}^0$	[Nm]	11	26	52	92	233	456
	Partial factor	$\gamma_{Ms,V}$	[-]	1,56					2,38
Concrete pry-out failure									
Factor	k_8		[-]	2,0					
Installation factor	γ_{inst}		[-]	1,0					
Concrete edge failure									
Effective length of fastener	l_f		[mm]	$\min(h_{ef}; 12 \cdot d_{nom})$					$\min(h_{ef}; 300\text{mm})$
Outside diameter of fastener	d_{nom}		[mm]	10	12	16	20	24	30
Installation factor	γ_{inst}		[-]	1,0					
¹⁾ Fastenings (incl. nut and washer) must comply with the appropriate material and property class of the internal threaded rod. The characteristic tension resistance for steel failure is valid for the internal threaded rod and the fastening element. ²⁾ For IG-M20 strength class 50 is valid									
TILCA® TIM U-H Injection System for concrete								Annex C 5	
Performances Characteristic values of shear loads under static and quasi-static action									

Table C6: Characteristic values of tension loads under static and quasi-static action													
Anchor size reinforcing bar			Ø 8	Ø 10	Ø 12	Ø 14	Ø 16	Ø 20	Ø 24	Ø 25	Ø 28	Ø 32	
Steel failure													
Characteristic tension resistance	$N_{Rk,s}$	[kN]	$A_s \cdot f_{uk}^{1)}$										
Cross section area	A_s	[mm ²]	50	79	113	154	201	314	452	491	616	804	
Partial factor	$\gamma_{Ms,N}$	[-]	1,4 ²⁾										
Combined pull-out and concrete failure													
Characteristic bond resistance in non-cracked concrete C20/25													
Temperature range	I: 80°C/50°C	Dry, wet concrete and flooded bore hole	$\tau_{Rk,ucr}$	[N/mm ²]	14	14	14	14	13	13	13	13	13
	II: 120°C/72°C		$\tau_{Rk,ucr}$	[N/mm ²]	13	12	12	12	12	11	11	11	11
	III: 160°C/100°C		$\tau_{Rk,ucr}$	[N/mm ²]	9,5	9,5	9,5	9,0	9,0	9,0	9,0	8,5	8,5
Characteristic bond resistance in cracked concrete C20/25													
Temperature range	I: 80°C/50°C	Dry, wet concrete and flooded bore hole	$\tau_{Rk,cr}$	[N/mm ²]	5,5	5,5	6,0	6,5	6,5	6,5	6,5	7,0	7,0
	II: 120°C/72°C		$\tau_{Rk,cr}$	[N/mm ²]	4,5	5,0	5,0	5,5	5,5	5,5	5,5	6,0	6,0
	III: 160°C/100°C		$\tau_{Rk,cr}$	[N/mm ²]	4,0	4,5	4,5	5,0	5,0	5,0	5,0	5,0	5,0
Increasing factors for concrete ψ_c			C25/30	1,02									
			C30/37	1,04									
			C35/45	1,07									
			C40/50	1,08									
			C45/55	1,09									
			C50/60	1,10									
Concrete cone failure													
Non-cracked concrete	$k_{ucr,N}$	[-]	11,0										
Cracked concrete	$k_{cr,N}$	[-]	7,7										
Edge distance	$c_{cr,N}$	[mm]	1,5 h_{ef}										
Axial distance	$s_{cr,N}$	[mm]	2 $c_{cr,N}$										
Splitting													
Edge distance	$h/h_{ef} \geq 2,0$	$c_{cr,sp}$	[mm]	1,0 h_{ef}									
	$2,0 > h/h_{ef} > 1,3$			$2 \cdot h_{ef} \left(2,5 - \frac{h}{h_{ef}} \right)$									
	$h/h_{ef} \leq 1,3$			2,4 h_{ef}									
Axial distance	$s_{cr,sp}$	[mm]	2 $c_{cr,sp}$										
Installation factor													
for dry and wet concrete	MAC	γ_{inst}	[-]	1,2					NPA				
	CAC			1,0									
	HDB			1,2									
for flooded bore hole	CAC	1,4											
¹⁾ f_{uk} shall be taken from the specifications of reinforcing bars ²⁾ in absence of national regulation													
TILCA® TIM U-H Injection System for concrete												Annex C 6	
Performances Characteristic values of tension loads under static and quasi-static action													

Table C7: Characteristic values of shear loads under static and quasi-static action														
Anchor size reinforcing bar			Ø 8	Ø 10	Ø 12	Ø 14	Ø 16	Ø 20	Ø 24	Ø 25	Ø 28	Ø 32		
Steel failure without lever arm														
Characteristic shear resistance	$V_{Rk,s}^0$	[kN]	$0,50 \cdot A_s \cdot f_{uk}^{1)}$											
Cross section area	A_s	[mm ²]	50	79	113	154	201	314	452	491	616	804		
Partial factor	$\gamma_{Ms,V}$	[-]	1,5 ²⁾											
Ductility factor	k_7	[-]	1,0											
Steel failure with lever arm														
Characteristic bending moment	$M_{Rk,s}^0$	[Nm]	$1.2 \cdot W_{el} \cdot f_{uk}^{1)}$											
Elastic section modulus	W_{el}	[mm ³]	50	98	170	269	402	785	896	1534	2155	3217		
Partial factor	$\gamma_{Ms,V}$	[-]	1,5 ²⁾											
Concrete pry-out failure														
Factor	k_8	[-]	2,0											
Installation factor	γ_{inst}	[-]	1,0											
Concrete edge failure														
Effective length of fastener	l_f	[mm]	$\min(h_{ef}; 12 \cdot d_{nom})$						$\min(h_{ef}; 300\text{mm})$					
Outside diameter of fastener	d_{nom}	[mm]	8	10	12	14	16	20	24	25	28	32		
Installation factor	γ_{inst}	[-]	1,0											
¹⁾ f_{uk} shall be taken from the specifications of reinforcing bars ²⁾ in absence of national regulation														
TILCA® TIM U-H Injection System for concrete										Annex C 7				
Performances			Characteristic values of shear loads under static and quasi-static action											

Table C8: Displacements under tension load¹⁾ (threaded rod)										
Anchor size threaded rod			M 8	M 10	M 12	M 16	M 20	M24	M 27	M 30
Non-cracked concrete C20/25 under static and quasi-static action										
Temperature range I: 80°C/50°C	δ_{N0} -factor	[mm/(N/mm ²)]	0,031	0,032	0,034	0,037	0,039	0,042	0,044	0,046
	$\delta_{N\infty}$ -factor	[mm/(N/mm ²)]	0,040	0,042	0,044	0,047	0,051	0,054	0,057	0,060
Temperature range II: 120°C/72°C	δ_{N0} -factor	[mm/(N/mm ²)]	0,032	0,034	0,035	0,038	0,041	0,044	0,046	0,048
	$\delta_{N\infty}$ -factor	[mm/(N/mm ²)]	0,042	0,044	0,045	0,049	0,053	0,056	0,059	0,062
Temperature range III: 160°C/100°C	δ_{N0} -factor	[mm/(N/mm ²)]	0,121	0,126	0,131	0,142	0,153	0,163	0,171	0,179
	$\delta_{N\infty}$ -factor	[mm/(N/mm ²)]	0,124	0,129	0,135	0,146	0,157	0,168	0,176	0,184
Cracked concrete C20/25 under static and quasi-static action										
Temperature range I: 80°C/50°C	δ_{N0} -factor	[mm/(N/mm ²)]	0,081	0,083	0,085	0,090	0,095	0,099	0,103	0,106
	$\delta_{N\infty}$ -factor	[mm/(N/mm ²)]	0,104	0,107	0,110	0,116	0,122	0,128	0,133	0,137
Temperature range II: 120°C/72°C	δ_{N0} -factor	[mm/(N/mm ²)]	0,084	0,086	0,088	0,093	0,098	0,103	0,107	0,110
	$\delta_{N\infty}$ -factor	[mm/(N/mm ²)]	0,108	0,111	0,114	0,121	0,127	0,133	0,138	0,143
Temperature range III: 160°C/100°C	δ_{N0} -factor	[mm/(N/mm ²)]	0,312	0,321	0,330	0,349	0,367	0,385	0,399	0,412
	$\delta_{N\infty}$ -factor	[mm/(N/mm ²)]	0,321	0,330	0,340	0,358	0,377	0,396	0,410	0,424
¹⁾ Calculation of the displacement $\delta_{N0} = \delta_{N0}\text{-factor} \cdot \tau$; τ : action bond stress for tension $\delta_{N\infty} = \delta_{N\infty}\text{-factor} \cdot \tau$;										
Table C9: Displacements under shear load²⁾ (threaded rod)										
Anchor size threaded rod			M 8	M 10	M 12	M 16	M 20	M24	M 27	M 30
Non-cracked and cracked concrete C20/25 under static and quasi-static action										
All temperature ranges	δ_{V0} -factor	[mm/kN]	0,06	0,06	0,05	0,04	0,04	0,03	0,03	0,03
	$\delta_{V\infty}$ -factor	[mm/kN]	0,09	0,08	0,08	0,06	0,06	0,05	0,05	0,05
²⁾ Calculation of the displacement $\delta_{V0} = \delta_{V0}\text{-factor} \cdot V$; V: action shear load $\delta_{V\infty} = \delta_{V\infty}\text{-factor} \cdot V$;										
TILCA® TIM U-H Injection System for concrete									Annex C 8	
Performances Displacements under static and quasi-static action (threaded rods)										

Table C10: Displacements under tension load¹⁾ (Internal threaded rod)

Anchor size Internal threaded rod			IG-M 6	IG-M 8	IG-M 10	IG-M 12	IG-M 16	IG-M 20
Non-cracked concrete C20/25 under static and quasi-static action								
Temperature range I: 80°C/50°C	δ_{N0} -factor	[mm/(N/mm ²)]	0,032	0,034	0,037	0,039	0,042	0,046
	$\delta_{N\infty}$ -factor	[mm/(N/mm ²)]	0,042	0,044	0,047	0,051	0,054	0,060
Temperature range II: 120°C/72°C	δ_{N0} -factor	[mm/(N/mm ²)]	0,034	0,035	0,038	0,041	0,044	0,048
	$\delta_{N\infty}$ -factor	[mm/(N/mm ²)]	0,044	0,045	0,049	0,053	0,056	0,062
Temperature range III: 160°C/100°C	δ_{N0} -factor	[mm/(N/mm ²)]	0,126	0,131	0,142	0,153	0,163	0,179
	$\delta_{N\infty}$ -factor	[mm/(N/mm ²)]	0,129	0,135	0,146	0,157	0,168	0,184
Cracked concrete C20/25 under static and quasi-static action								
Temperature range I: 80°C/50°C	δ_{N0} -factor	[mm/(N/mm ²)]	0,083	0,085	0,090	0,095	0,099	0,106
	$\delta_{N\infty}$ -factor	[mm/(N/mm ²)]	0,170	0,110	0,116	0,122	0,128	0,137
Temperature range II: 120°C/72°C	δ_{N0} -factor	[mm/(N/mm ²)]	0,086	0,088	0,093	0,098	0,103	0,110
	$\delta_{N\infty}$ -factor	[mm/(N/mm ²)]	0,111	0,114	0,121	0,127	0,133	0,143
Temperature range III: 160°C/100°C	δ_{N0} -factor	[mm/(N/mm ²)]	0,321	0,330	0,349	0,367	0,385	0,412
	$\delta_{N\infty}$ -factor	[mm/(N/mm ²)]	0,330	0,340	0,358	0,377	0,396	0,424

¹⁾ Calculation of the displacement

$$\delta_{N0} = \delta_{N0}\text{-factor} \cdot \tau;$$

τ : action bond stress for tension

$$\delta_{N\infty} = \delta_{N\infty}\text{-factor} \cdot \tau;$$

Table C11: Displacements under shear load²⁾ (Internal threaded rod)

Anchor size Internal threaded rod			IG-M 6	IG-M 8	IG-M 10	IG-M 12	IG-M 16	IG-M 20
Non-cracked and cracked concrete C20/25 under static and quasi-static action								
All temperature ranges	δ_{V0} -factor	[mm/kN]	0,07	0,06	0,06	0,05	0,04	0,04
	$\delta_{V\infty}$ -factor	[mm/kN]	0,10	0,09	0,08	0,08	0,06	0,06

²⁾ Calculation of the displacement

$$\delta_{V0} = \delta_{V0}\text{-factor} \cdot V;$$

V: action shear load

$$\delta_{V\infty} = \delta_{V\infty}\text{-factor} \cdot V;$$

TILCA® TIM U-H Injection System for concrete

Performances

Displacements under static and quasi-static action (Internal threaded anchor rod)

Annex C 9

Table C12: Displacements under tension load¹⁾ (rebar)												
Anchor size reinforcing bar			Ø 8	Ø 10	Ø 12	Ø 14	Ø 16	Ø 20	Ø 24	Ø 25	Ø 28	Ø 32
Non-cracked concrete C20/25 under static and quasi-static action												
Temperature range I: 80°C/50°C	δ _{N0} -factor	[mm/(N/mm ²)]	0,031	0,032	0,034	0,035	0,037	0,039	0,042	0,043	0,045	0,048
	δ _{N∞} -factor	[mm/(N/mm ²)]	0,040	0,042	0,044	0,045	0,047	0,051	0,054	0,055	0,058	0,063
Temperature range II: 120°C/72°C	δ _{N0} -factor	[mm/(N/mm ²)]	0,032	0,034	0,035	0,036	0,038	0,041	0,044	0,045	0,047	0,050
	δ _{N∞} -factor	[mm/(N/mm ²)]	0,042	0,044	0,045	0,047	0,049	0,053	0,056	0,057	0,060	0,065
Temperature range III: 160°C/100°C	δ _{N0} -factor	[mm/(N/mm ²)]	0,121	0,126	0,131	0,137	0,142	0,153	0,163	0,164	0,172	0,186
	δ _{N∞} -factor	[mm/(N/mm ²)]	0,124	0,129	0,135	0,141	0,146	0,157	0,168	0,169	0,177	0,192
Cracked concrete C20/25 under static and quasi-static action												
Temperature range I: 80°C/50°C	δ _{N0} -factor	[mm/(N/mm ²)]	0,081	0,083	0,085	0,087	0,090	0,095	0,099	0,099	0,103	0,108
	δ _{N∞} -factor	[mm/(N/mm ²)]	0,104	0,107	0,110	0,113	0,116	0,122	0,128	0,128	0,133	0,141
Temperature range II: 120°C/72°C	δ _{N0} -factor	[mm/(N/mm ²)]	0,084	0,086	0,088	0,090	0,093	0,098	0,103	0,103	0,107	0,113
	δ _{N∞} -factor	[mm/(N/mm ²)]	0,108	0,111	0,114	0,118	0,121	0,127	0,133	0,133	0,138	0,148
Temperature range III: 160°C/100°C	δ _{N0} -factor	[mm/(N/mm ²)]	0,312	0,321	0,330	0,340	0,349	0,367	0,385	0,385	0,399	0,425
	δ _{N∞} -factor	[mm/(N/mm ²)]	0,321	0,330	0,340	0,349	0,358	0,377	0,396	0,396	0,410	0,449
¹⁾ Calculation of the displacement δ _{N0} = δ _{N0} -factor · τ; τ: action bond stress for tension δ _{N∞} = δ _{N∞} -factor · τ;												
Table C13: Displacements under shear load²⁾ (rebar)												
Anchor size reinforcing bar			Ø 8	Ø 10	Ø 12	Ø 14	Ø 16	Ø 20	Ø 24	Ø 25	Ø 28	Ø 32
For concrete C20/25 under static and quasi-static action												
All temperature ranges	δ _{V0} -factor	[mm/kN]	0,06	0,05	0,05	0,04	0,04	0,04	0,03	0,03	0,03	0,03
	δ _{V∞} -factor	[mm/kN]	0,09	0,08	0,08	0,06	0,06	0,05	0,05	0,05	0,04	0,04
²⁾ Calculation of the displacement δ _{V0} = δ _{V0} -factor · V; V: action shear load δ _{V∞} = δ _{V∞} -factor · V;												
TILCA® TIM U-H Injection System for concrete										Annex C 10		
Performances Displacements under static and quasi-static action (rebar)												

Table C14: Characteristic values of tension loads under seismic action (performance category C1+C2)												
Anchor size threaded rod			M 8	M 10	M 12	M 16	M 20	M24	M27	M30		
Steel failure												
Characteristic tension resistance (Seismic C1)		$N_{Rk,s,eq,C1}$	[kN]	$1,0 \cdot N_{Rk,s}$								
Characteristic tension resistance, (Seismic C2) Steel, strength class 8.8 Stainless Steel A4 and HCR, Strength class ≥ 70		$N_{Rk,s,eq,C2}$	[kN]	NPA				$1,0 \cdot N_{Rk,s}$		NPA		
Partial factor		$\gamma_{Ms,N}$	[-]	see Table C1								
Combined pull-out and concrete failure												
Characteristic bond resistance in cracked and non-cracked concrete C20/25												
Temperature range	I: 80°C/50°C	Dry, wet concrete and flooded bore hole	$\tau_{Rk,eq,C1}$	[N/mm ²]	7,0	7,5	8,0	9,0	8,5	7,0	7,0	7,0
			$\tau_{Rk,eq,C2}$	[N/mm ²]	NPA		3,6	3,5	3,3	2,3	NPA	
	II: 120°C/72°C		$\tau_{Rk,eq,C1}$	[N/mm ²]	6,0	6,5	7,0	7,5	7,0	6,0	6,0	6,0
			$\tau_{Rk,eq,C2}$	[N/mm ²]	NPA		3,1	3,0	2,8	2,0	NPA	
	III: 160°C/100°C		$\tau_{Rk,eq,C1}$	[N/mm ²]	5,5	5,5	6,0	6,5	6,0	5,5	5,5	5,5
			$\tau_{Rk,eq,C2}$	[N/mm ²]	NPA		2,5	2,7	2,5	1,8	NPA	
Increasing factors for concrete ψ_c		C25/30 to C50/60		1,0								
Concrete cone failure												
Non-cracked concrete		$k_{ucr,N}$	[-]	11,0								
Cracked concrete		$k_{cr,N}$	[-]	7,7								
Edge distance		$c_{cr,N}$	[mm]	$1,5 h_{ef}$								
Axial distance		$s_{cr,N}$	[mm]	$2 c_{cr,N}$								
Splitting												
Edge distance	$h/h_{ef} \geq 2,0$	$c_{cr,sp}$	[mm]	$1,0 h_{ef}$								
	$2,0 > h/h_{ef} > 1,3$			$2 \cdot h_{ef} \left(2,5 - \frac{h}{h_{ef}} \right)$								
	$h/h_{ef} \leq 1,3$			$2,4 h_{ef}$								
Axial distance		$s_{cr,sp}$	[mm]	$2 c_{cr,sp}$								
Installation factor												
for dry and wet concrete	CAC	γ_{inst}	[-]	1,0								
	HDB			1,2								
for flooded bore hole	CAC			1,4								
TILCA® TIM U-H Injection System for concrete										Annex C 11		
Performances Characteristic values of tension loads under seismic action (performance category C1+C2)												

Table C15: Characteristic values of shear loads under seismic action (performance category C1+C2)											
Anchor size threaded rod			M 8	M 10	M 12	M 16	M 20	M24	M 27	M 30	
Steel failure without lever arm											
Characteristic shear resistance (Seismic C1)	$V_{Rk,s,eq,C1}$	[kN]	$0,70 \cdot V_{Rk,s}^0$								
Characteristic shear resistance (Seismic C2), Steel, strength class 8.8 Stainless Steel A4 and HCR, Strength class ≥ 70	$V_{Rk,s,eq,C2}$	[kN]	NPA			$0,70 \cdot V_{Rk,s}^0$			NPA		
Partial factor	$\gamma_{Ms,V}$	[-]	see Table C1								
Ductility factor	k_7	[-]	1,0								
Steel failure with lever arm											
Characteristic bending moment	$M_{Rk,s,eq,C1}^0$	[Nm]	No Performance Assessed (NPA)								
	$M_{Rk,s,eq,C2}^0$	[Nm]	No Performance Assessed (NPA)								
Concrete pry-out failure											
Factor	k_8	[-]	2,0								
Installation factor	γ_{inst}	[-]	1,0								
Concrete edge failure											
Effective length of fastener	l_f	[mm]	$\min(h_{ef}; 12 \cdot d_{nom})$						$\min(h_{ef}; 300\text{mm})$		
Outside diameter of fastener	d_{nom}	[mm]	8	10	12	16	20	24	27	30	
Installation factor	γ_{inst}	[-]	1,0								
Factor for annular gap	α_{gap}	[-]	$0,5 (1,0)^{1)}$								
¹⁾ Value in brackets valid for filled annular gab between anchor and clearance hole in the fixture. Use of special filling washer Annex A 3 is required											
TILCA® TIM U-H Injection System for concrete									Annex C 12		
Performances Characteristic values of shear loads under seismic action (performance category C1+C2)											

Table C16: Characteristic values of tension loads under seismic action (performance category C1)														
Anchor size reinforcing bar			Ø 8	Ø 10	Ø 12	Ø 14	Ø 16	Ø 20	Ø 24	Ø 25	Ø 28	Ø 32		
Steel failure														
Characteristic tension resistance	$N_{Rk,s,eq}$	[kN]	$1,0 \cdot A_s \cdot f_{uk}^{1)}$											
Cross section area	A_s	[mm ²]	50	79	113	154	201	314	452	491	616	804		
Partial factor	$\gamma_{Ms,N}$	[-]	$1,4^{2)}$											
Combined pull-out and concrete failure														
Characteristic bond resistance in cracked and non-cracked concrete C20/25														
Temperature range	I: 80°C/50°C	Dry, wet concrete and flooded bore hole	$\tau_{Rk,eq}$	[N/mm ²]	5,5	5,5	6,0	6,5	6,5	6,5	6,5	7,0	7,0	7,0
	II: 120°C/72°C		$\tau_{Rk,eq}$	[N/mm ²]	4,5	5,0	5,0	5,5	5,5	5,5	5,5	6,0	6,0	6,0
	III: 160°C/100°C		$\tau_{Rk,eq}$	[N/mm ²]	4,0	4,5	4,5	5,0	5,0	5,0	5,0	5,0	5,0	5,0
Increasing factors for concrete ψ_c		C25/30 to C50/60	1,0											
Concrete cone failure														
Non-cracked concrete	$k_{ucr,N}$	[-]	11,0											
Cracked concrete	$k_{cr,N}$	[-]	7,7											
Edge distance	$c_{cr,N}$	[mm]	$1,5 h_{ef}$											
Axial distance	$s_{cr,N}$	[mm]	$2 c_{cr,N}$											
Splitting														
Edge distance	$h/h_{ef} \geq 2,0$	$c_{cr,sp}$	[mm]	$1,0 h_{ef}$										
	$2,0 > h/h_{ef} > 1,3$			$2 \cdot h_{ef} \left(2,5 - \frac{h}{h_{ef}} \right)$										
	$h/h_{ef} \leq 1,3$			$2,4 h_{ef}$										
Axial distance	$s_{cr,sp}$	[mm]	$2 c_{cr,sp}$											
Installation factor														
for dry and wet concrete	CAC	γ_{inst}	[-]	1,0										
	HDB			1,2										
for flooded bore hole	CAC	1,4												
¹⁾ f_{uk} shall be taken from the specifications of reinforcing bars ²⁾ in absence of national regulation														
TILCA® TIM U-H Injection System for concrete												Annex C 13		
Performances Characteristic values of tension loads under seismic action (performance category C1)														

Table C17: Characteristic values of shear loads under seismic action (performance category C1)														
Anchor size reinforcing bar			Ø 8	Ø 10	Ø 12	Ø 14	Ø 16	Ø 20	Ø 24	Ø 25	Ø 28	Ø 32		
Steel failure without lever arm														
Characteristic shear resistance	$V_{Rk,s,eq}$	[kN]	$0,35 \cdot A_s \cdot f_{uk}^{1)}$											
Cross section area	A_s	[mm ²]	50	79	113	154	201	314	452	491	616	804		
Partial factor	$\gamma_{Ms,V}$	[-]	1,5 ²⁾											
Ductility factor	k_7	[-]	1,0											
Steel failure with lever arm														
Characteristic bending moment	$M_{Rk,s,eq}^0$	[Nm]	No Performance Assessed (NPA)											
Concrete pry-out failure														
Factor	k_8	[-]	2,0											
Installation factor	γ_{inst}	[-]	1,0											
Concrete edge failure														
Effective length of fastener	l_f	[mm]	$\min(h_{ef}; 12 \cdot d_{nom})$							$\min(h_{ef}; 300\text{mm})$				
Outside diameter of fastener	d_{nom}	[mm]	8	10	12	14	16	20	24	25	28	32		
Installation factor	γ_{inst}	[-]	1,0											
Factor for annular gap	α_{gap}	[-]	0,5 (1,0)³⁾											
¹⁾ f_{uk} shall be taken from the specifications of reinforcing bars ²⁾ in absence of national regulation ³⁾ Value in brackets valid for filled annular gap between anchor and clearance hole in the fixture. Use of special filling washer Annex A 3 is required														
TILCA® TIM U-H Injection System for concrete										Annex C 14				
Performances Characteristic values of shear loads under seismic action (performance category C1)														

Table C18: Displacements under tension load¹⁾ (threaded rod)										
Anchor size threaded rod			M 8	M 10	M 12	M 16	M 20	M24	M 27	M 30
Cracked concrete C20/25 under seismic C1 action										
Temperature range I: 80°C/50°C	δ_{N0} -factor	[mm/(N/mm ²)]	0,081	0,083	0,085	0,090	0,095	0,099	0,103	0,106
	$\delta_{N\infty}$ -factor	[mm/(N/mm ²)]	0,104	0,107	0,110	0,116	0,122	0,128	0,133	0,137
Temperature range II: 120°C/72°C	δ_{N0} -factor	[mm/(N/mm ²)]	0,084	0,086	0,088	0,093	0,098	0,103	0,107	0,110
	$\delta_{N\infty}$ -factor	[mm/(N/mm ²)]	0,108	0,111	0,114	0,121	0,127	0,133	0,138	0,143
Temperature range III: 160°C/100°C	δ_{N0} -factor	[mm/(N/mm ²)]	0,312	0,321	0,330	0,349	0,367	0,385	0,399	0,412
	$\delta_{N\infty}$ -factor	[mm/(N/mm ²)]	0,321	0,330	0,340	0,358	0,377	0,396	0,410	0,424

Table C19: Displacements under tension load¹⁾ (rebar)												
Anchor size reinforcing bar			Ø 8	Ø 10	Ø 12	Ø 14	Ø 16	Ø 20	Ø 24	Ø 25	Ø 28	Ø 32
Cracked concrete C20/25 under seismic C1 action												
Temperature range I: 80°C/50°C	δ_{N0} -factor	[mm/(N/mm ²)]	0,081	0,083	0,085	0,087	0,090	0,095	0,099	0,099	0,103	0,108
	$\delta_{N\infty}$ -factor	[mm/(N/mm ²)]	0,104	0,107	0,110	0,113	0,116	0,122	0,128	0,128	0,133	0,141
Temperature range II: 120°C/72°C	δ_{N0} -factor	[mm/(N/mm ²)]	0,084	0,086	0,088	0,090	0,093	0,098	0,103	0,103	0,107	0,113
	$\delta_{N\infty}$ -factor	[mm/(N/mm ²)]	0,108	0,111	0,114	0,118	0,121	0,127	0,133	0,133	0,138	0,148
Temperature range III: 160°C/100°C	δ_{N0} -factor	[mm/(N/mm ²)]	0,312	0,321	0,330	0,340	0,349	0,367	0,385	0,385	0,399	0,425
	$\delta_{N\infty}$ -factor	[mm/(N/mm ²)]	0,321	0,330	0,340	0,349	0,358	0,377	0,396	0,396	0,410	0,449

¹⁾ Calculation of the displacement

$$\delta_{N0} = \delta_{N0}\text{-factor} \cdot \tau;$$

$$\delta_{N\infty} = \delta_{N\infty}\text{-factor} \cdot \tau; (\tau: \text{action bond stress for tension})$$

Table C20: Displacements under shear load²⁾ (threaded rod)										
Anchor size threaded rod			M 8	M 10	M 12	M 16	M 20	M24	M 27	M 30
Non-cracked and cracked concrete C20/25 under seismic C1 action										
All temperature ranges	δ_{V0} -factor	[mm/kN]	0,06	0,06	0,05	0,04	0,04	0,03	0,03	0,03
	$\delta_{V\infty}$ -factor	[mm/kN]	0,09	0,08	0,08	0,06	0,06	0,05	0,05	0,05

Table C21: Displacement under shear load¹⁾ (rebar)												
Anchor size reinforcing bar			Ø 8	Ø 10	Ø 12	Ø 14	Ø 16	Ø 20	Ø 24	Ø 25	Ø 28	Ø 32
For concrete C20/25 under seismic C1 action												
All temperature ranges	δ_{V0} -factor	[mm/kN]	0,06	0,05	0,05	0,04	0,04	0,04	0,03	0,03	0,03	0,03
	$\delta_{V\infty}$ -factor	[mm/kN]	0,09	0,08	0,08	0,06	0,06	0,05	0,05	0,05	0,04	0,04

²⁾ Calculation of the displacement

$$\delta_{V0} = \delta_{V0}\text{-factor} \cdot V;$$

$$\delta_{V\infty} = \delta_{V\infty}\text{-factor} \cdot V; (V: \text{action shear load})$$

TILCA® TIM U-H Injection System for concrete	Annex C 15
Performances Displacements under seismic C1 action (threaded rods and rebar)	

Table C22: Displacements under tension load¹⁾ (threaded rod)

Anchor size threaded rod		M 8	M 10	M 12	M 16	M 20	M 24	M 27	M 30
Cracked concrete C20/25 under seismic C2 action									
All temperature ranges	$\delta_{N,eq(DLS)}$ -factor	[mm/(N/mm ²)]	NPA	0,120	0,100	0,100	0,120	NPA	
	$\delta_{N,eq(ULS)}$ -factor	[mm/(N/mm ²)]		0,140	0,150	0,110	0,150		

¹⁾ Calculation of the displacement

$$\delta_{N,eq(DLS)} = \delta_{N,eq(DLS)\text{-factor}} \cdot \tau;$$

$$\delta_{N,eq(ULS)} = \delta_{N,eq(ULS)\text{-factor}} \cdot \tau; \quad (\tau: \text{action bond stress for tension})$$

Table C23: Displacements under shear load²⁾ (threaded rod)

Anchor size threaded rod		M 8	M 10	M 12	M 16	M 20	M 24	M 27	M 30
Cracked concrete C20/25 under seismic C2 action									
All temperature ranges	$\delta_{V,eq(DLS)}$ -factor	[mm/kN]	NPA	0,27	0,13	0,09	0,06	NPA	
	$\delta_{V,eq(ULS)}$ -factor	[mm/kN]		0,27	0,14	0,10	0,08		

²⁾ Calculation of the displacement

$$\delta_{V,eq(DLS)} = \delta_{V,eq(DLS)\text{-factor}} \cdot V;$$

$$\delta_{V,eq(ULS)} = \delta_{V,eq(ULS)\text{-factor}} \cdot V; \quad (V: \text{action shear load})$$

TILCA® TIM U-H Injection System for concrete

Performances

Displacements under seismic C2 action (threaded rods)

Annex C 16