

Approval body for construction products
and types of construction

Bautechnisches Prüfamt

An institution established by the Federal and
Laender Governments



European Technical Assessment

ETA-98/0001
of 2 October 2019

English translation prepared by DIBt - Original version in German language

General Part

Technical Assessment Body issuing the
European Technical Assessment:

Deutsches Institut für Bautechnik

Trade name of the construction product

Hilti metal expansion anchor HST, HST-R, HST-HCR,
HST3, HST3-R

Product family
to which the construction product belongs

Mechanical fastener for use in concrete

Manufacturer

Hilti Aktiengesellschaft
Business Unit Anchors
9494 Schaan
FÜRSTENTUM LIECHTENSTEIN

Manufacturing plant

Hilti Werke

This European Technical Assessment
contains

62 pages including 3 annexes which form an integral part
of this assessment

This European Technical Assessment is
issued in accordance with Regulation (EU)
No 305/2011, on the basis of

EAD 330232-00-0601

This version replaces

ETA-98/0001 issued on 9 February 2018

The European Technical Assessment is issued by the Technical Assessment Body in its official language. Translations of this European Technical Assessment in other languages shall fully correspond to the original issued document and shall be identified as such.

Communication of this European Technical Assessment, including transmission by electronic means, shall be in full. However, partial reproduction may only be made with the written consent of the issuing Technical Assessment Body. Any partial reproduction shall be identified as such.

This European Technical Assessment may be withdrawn by the issuing Technical Assessment Body, in particular pursuant to information by the Commission in accordance with Article 25(3) of Regulation (EU) No 305/2011.

Specific Part

1 Technical description of the product

The Hilti metal expansion anchor HST, HST-R, HST-HCR, HST3 and HST3-R is an anchor made of galvanized steel (HST, HST3), stainless steel (HST-R, HST3-R) or high corrosion resistant steel (HST-HCR) which is placed into a drilled hole and anchored by torque controlled expansion.

The product description is given in Annex A.

2 Specification of the intended use in accordance with the applicable European Assessment Document

The performances given in Section 3 are only valid if the anchor is used in compliance with the specifications and conditions given in Annex B.

The verifications and assessment methods on which this European Technical Assessment is based lead to the assumption of a working life of the anchor of at least 50 years. The indications given on the working life cannot be interpreted as a guarantee given by the producer, but are to be regarded only as a means for choosing the right products in relation to the expected economically reasonable working life of the works.

3 Performance of the product and references to the methods used for its assessment

3.1 Mechanical resistance and stability (BWR 1)

Essential characteristic	Performance
Characteristic resistance under static and quasi-static loading, displacements	See Annex C1 to C12
Characteristic resistance for seismic performance category C1	See Annex C13 to C16
Characteristic resistance for seismic performance category C2, displacements	See Annex C17 to C22
Durability	See Annex B1

3.2 Safety in case of fire (BWR 2)

Essential characteristic	Performance
Reaction to fire	Class A1
Resistance to fire	See Annex C23 to C32

English translation prepared by DIBt

4 Assessment and verification of constancy of performance (AVCP) system applied, with reference to its legal base

In accordance with the European Assessment Document EAD 330232-00-0601 the applicable European legal act is: [96/582/EC].

The system to be applied is: 1

5 Technical details necessary for the implementation of the AVCP system, as provided for in the applicable EAD

Technical details necessary for the implementation of the AVCP system are laid down in the control plan deposited with Deutsches Institut für Bautechnik.

Issued in Berlin on 2 October 2019 by Deutsches Institut für Bautechnik

Dr.-Ing. Lars Eckfeldt
p. p. Head of Department

beglaubigt:
Lange

Installed condition

Figure A1:

Hilti metal expansion anchor HST, HST-R and HST-HCR

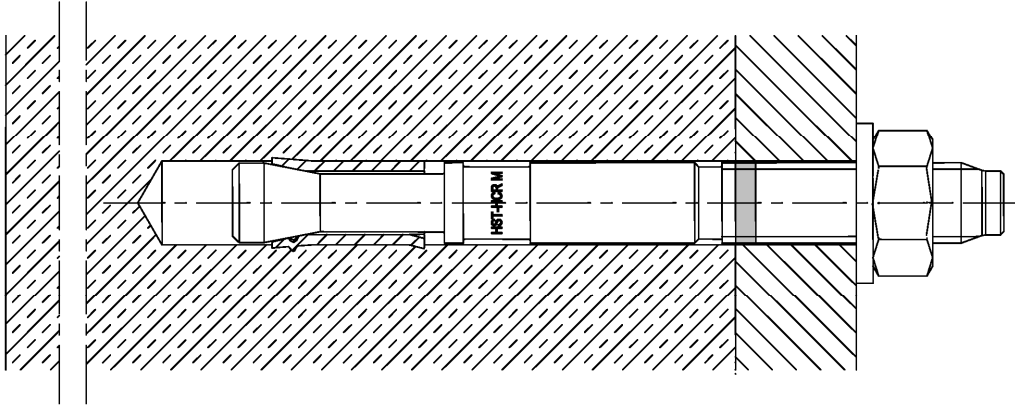
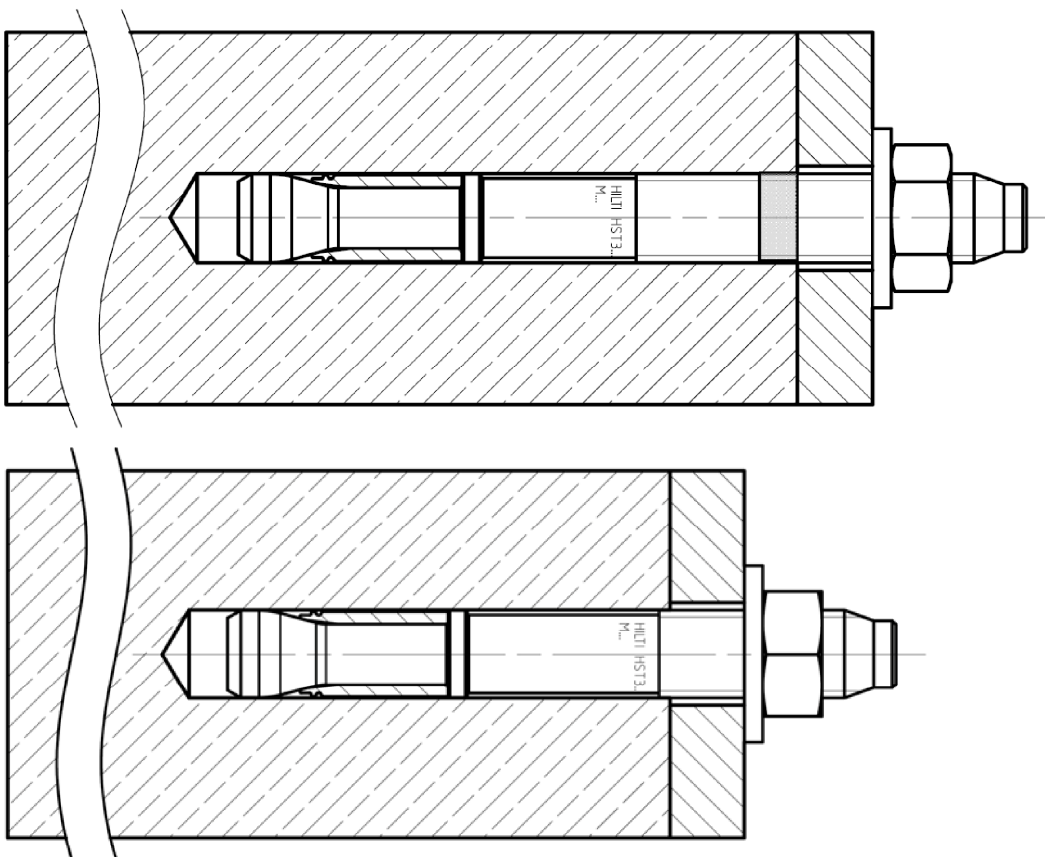

Figure A2:

Hilti metal expansion anchor HST3 and HST3-R with standard and shallow embedment depth



Hilti metal expansion anchor HST, HST-R, HST-HCR, HST3, HST3-R

Product description
Installed condition

Annex A1

Figure A3:

Hilti metal expansion anchor HST3 and HST3-R with Filling Set

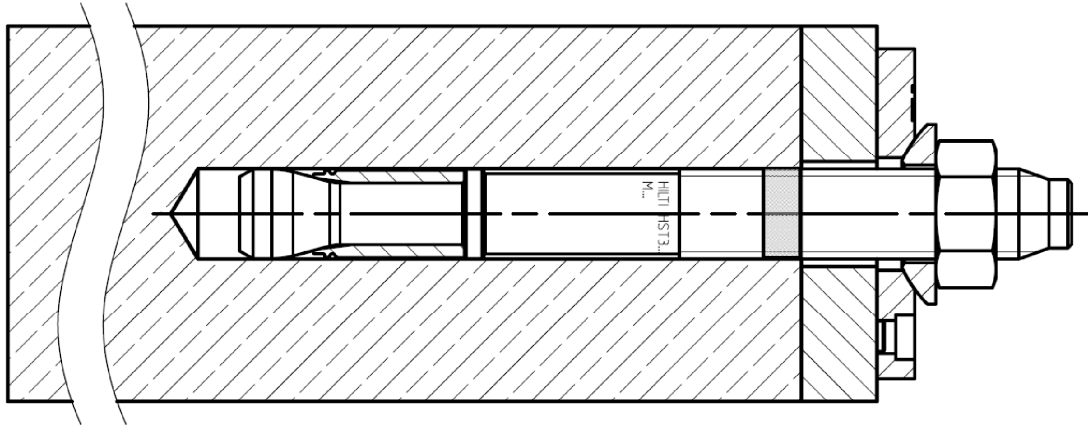

Hilti metal expansion anchor HST, HST-R, HST-HCR, HST3, HST3-R

Product description
Installed condition

Annex A2

Product description: Hilti metal expansion anchor HST, HST-R and HST-HCR

Cold-formed version

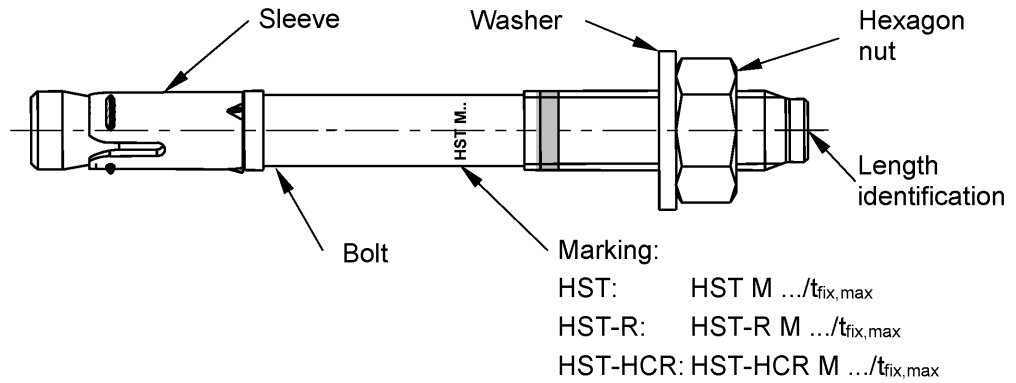

Machined version

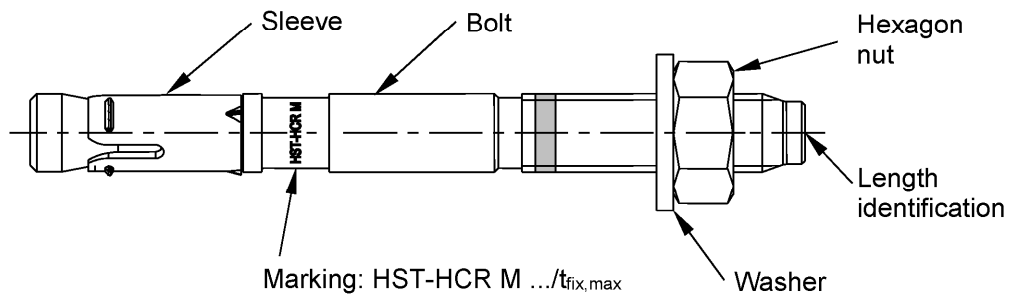

Hilti metal expansion anchor HST, HST-R, HST-HCR, HST3, HST3-R

Product description
Anchor types, marking and identification

Annex A3

Product description: Hilti metal expansion anchor HST3 and HST3-R

Cold-formed version

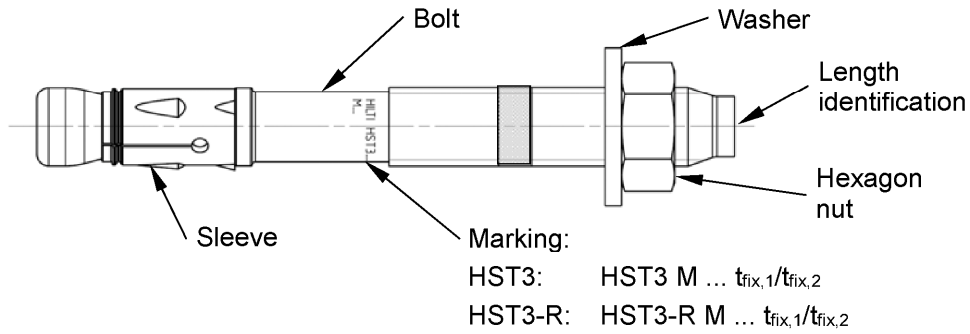

Machined version M8 - M16

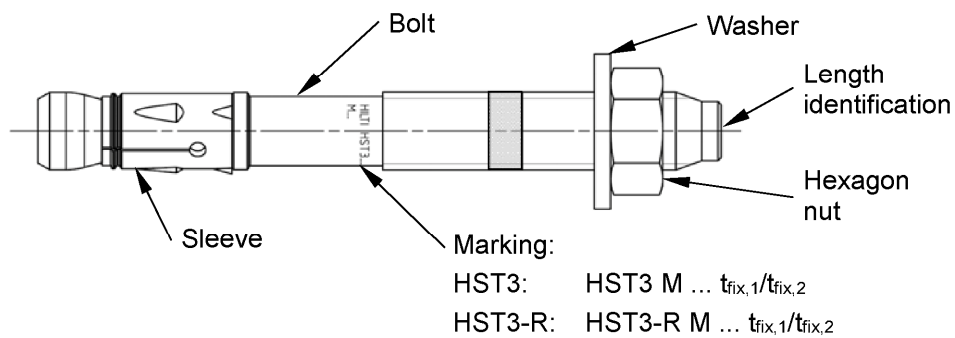

Machined version M20 - M24

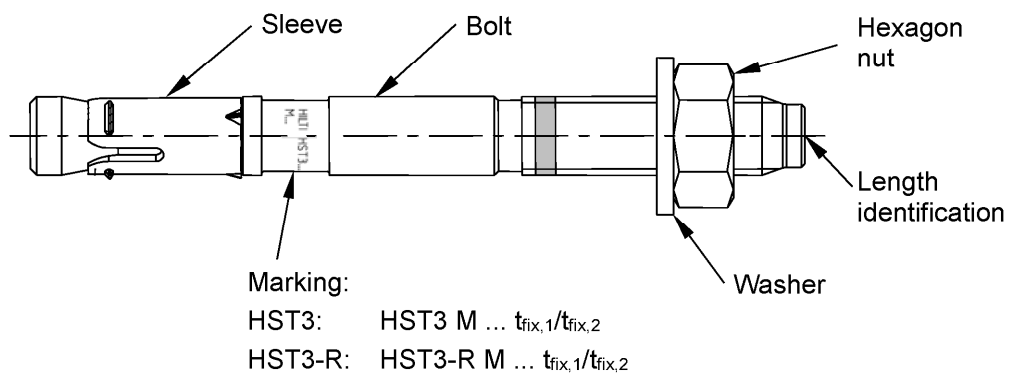

Electronic copy of the ETA by DIBt: ETA-98/0001

Hilti metal expansion anchor HST, HST-R, HST-HCR, HST3, HST3-R

Product description
Anchor types, marking and identification

Annex A4

Table A1: Length identification HST, HST3, HST-R, HST3-R, HST-HCR

Letter		A	B	C	D	E	f	II
Anchor length	≥ [mm]	38,1	50,8	63,5	76,2	88,9	100,0	100,0
	< [mm]	50,8	63,5	76,2	88,9	101,6	100,0	100,0

Letter		F	G	Δ	H	I	J	K
Anchor length	≥ [mm]	101,6	114,3	125,0	127,0	139,7	152,4	165,1
	< [mm]	114,3	127,0	125,0	139,7	152,4	165,1	177,8

Letter		L	M	N	O	P	Q	R
Anchor length	≥ [mm]	177,8	190,5	203,2	215,9	228,6	241,3	254,0
	< [mm]	190,5	203,2	215,9	228,6	241,3	254,0	279,4

Letter		r	S	T	U	V	W	X
Anchor length	≥ [mm]	260,0	279,4	304,8	330,2	355,6	381,0	406,4
	< [mm]	260,0	304,8	330,2	355,6	381,0	406,4	431,8

Letter		Y	Z	AA	BB	CC	DD	EE
Anchor length	≥ [mm]	431,8	457,2	482,6	508,0	533,4	558,8	584,2
	< [mm]	457,2	482,6	508,0	533,4	558,8	584,2	609,6

Letter		FF	GG	HH	II	JJ	KK	LL
Anchor length	≥ [mm]	609,6	635,0	660,4	685,8	711,2	736,6	762,0
	< [mm]	635,0	660,4	685,8	711,2	736,6	762,0	787,4

Letter		MM	NN	OO	PP	QQ	RR	SS
Anchor length	≥ [mm]	787,4	812,8	838,2	863,6	889,0	914,4	939,8
	< [mm]	812,8	838,2	863,6	889,0	914,4	939,8	965,2

Letter		TT	UU	VV
Anchor length	≥ [mm]	965,2	990,6	1016,0
	< [mm]	990,6	1016,0	1041,4

Hilti metal expansion anchor HST, HST-R, HST-HCR, HST3, HST3-R

Product description
Anchor types, marking and identification

Annex A5

Table A2: Materials

Designation	Material
HST (Carbon steel)	
Expansion sleeve	Stainless steel A4
Bolt	Carbon steel, galvanized, coated (transparent), rupture elongation ($l_0 = 5d$) > 8 %
Washer	Carbon steel, galvanized
Hexagon nut	Carbon steel, galvanized
HST-R (Stainless steel)	
Expansion sleeve	Stainless steel A4
Bolt	Stainless steel A4, cone coated (red or transparent), rupture elongation ($l_0 = 5d$) > 8 %
Washer	Stainless steel A4
Hexagon nut	Stainless steel A4, coated
HST-HCR (High corrosion resistance steel)	
Expansion sleeve	Stainless steel A4
Bolt	High corrosion resistance steel, cone coated (red), rupture elongation ($l_0 = 5d$) > 8 %
Washer	High corrosion resistance steel
Hexagon nut	High corrosion resistance steel, coated

Hilti metal expansion anchor HST, HST-R, HST-HCR, HST3, HST3-R

Product description
Materials

Annex A6

Table A2 continued

Designation	Material
HST3 (Carbon steel)	
Expansion sleeve	M10, M16: Carbon steel, galvanized or stainless steel M8, M12, M20, M24: Stainless steel
Bolt	Carbon steel, galvanized, coated (transparent), rupture elongation ($l_0 = 5d$) > 8 %
Washer	Carbon steel, galvanized
Hexagon nut	Carbon steel, galvanized
Filling Set (Carbon steel)	
Sealing washer	Carbon steel, galvanized
Spherical washer	Carbon steel, galvanized
HST3-R (Stainless steel)	
Expansion sleeve	Stainless steel A4
Bolt	Stainless steel A4, cone coated (transparent), rupture elongation ($l_0 = 5d$) > 8 %
Washer	Stainless steel A4
Hexagon nut	Stainless steel A4, coated
Filling Set (Stainless steel)	
Sealing washer	Stainless steel A4
Spherical washer	Stainless steel A4

Hilti metal expansion anchor HST, HST-R, HST-HCR, HST3, HST3-R

Product description
Materials

Annex A7

Injection mortar Hilti HIT-HY 200-A

Hybrid system with resin, hardener, cement and water components
Foil pack 330 ml and 500 ml

Marking:
HILTI HIT
Production number and
production line
Expiry date mm/yyyy



Product name: "Hilti HIT-HY 200-A"

Static mixer Hilti HIT-RE-M



Dispensers



Hilti HDM 330



Hilti HDE 500

Table A3: curing time Hilti HIT-HY 200-A

Temperature of base material / environment	Curing time t_{cure} Hilti HIT-HY 200-A
-10 °C to -5 °C	7 hours
-4 °C to 0 °C	4 hours
1 °C to 5 °C	2 hours
6 °C to 10 °C	75 minutes
11 °C to 20 °C	45 minutes
21 °C to 30 °C	30 minutes
31 °C to 40 °C	30 minutes

Hilti metal expansion anchor HST, HST-R, HST-HCR, HST3, HST3-R

Product description
Injection mortar

Annex A8

Table A4: Dimensions HST, HST-R and HST-HCR

HST, HST-R, HST-HCR			M8	M10	M12	M16	M20 ¹⁾	M24 ¹⁾
Maximum length of anchor	$l_{\max} \leq$	[mm]	260	280	295	350	450	500
Shaft diameter at the cone	d_R	[mm]	5,5	7,2	8,5	11,6	14,6	17,4
Length of expansion sleeve	l_s	[mm]	14,8	18,2	22,7	24,3	28,3	36,0

¹⁾ Only HST and HST-R

HST, HST-R and HST-HCR

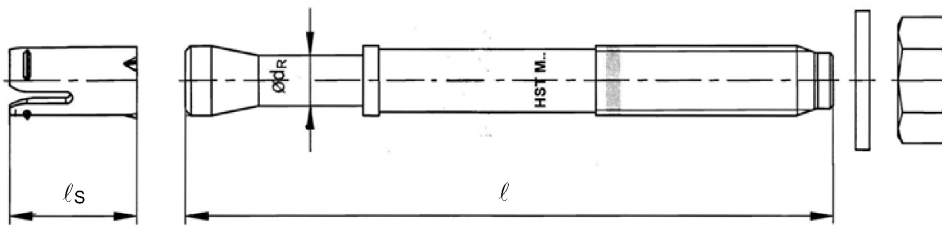
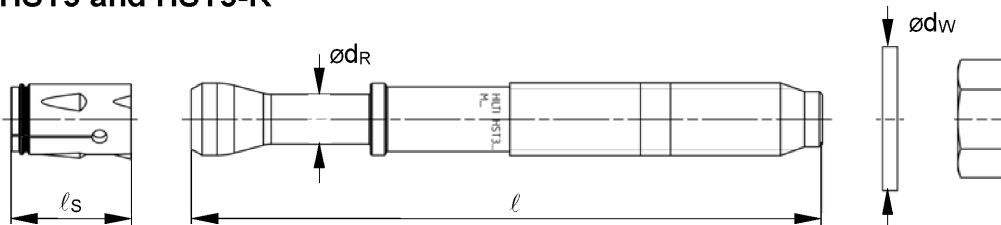

Table A5: Dimensions HST3 and HST3-R

HST3, HST3-R			M8	M10	M12	M16	M20	M24
Maximum length of anchor	$l_{\max} \leq$	[mm]	260	280	350	475	450	500
Shaft diameter at the cone	d_R	[mm]	5,60	6,94	8,22	11,00	14,62	17,4
Length of expansion sleeve	l_s	[mm]	13,6	16,0	20,0	25,0	28,3	36,0
Diameter of washer	$d_w \geq$	[mm]	15,57	19,48	23,48	29,48	36,38	43,38

HST3 and HST3-R



Hilti metal expansion anchor HST, HST-R, HST-HCR, HST3, HST3-R

Product description
Dimensions

Annex A9

Filling Set to fill the annular gap between anchor and fixture

Table A6: Dimensions Filling Set

Filling Set used for HST3, HST3-R			M8	M10	M12	M16	M20
Diameter of sealing washer	d _{vs}	[mm]	38	42	44	52	60
Thickness of sealing washer	h _{vs}	[mm]	5			6	

Sealing washer

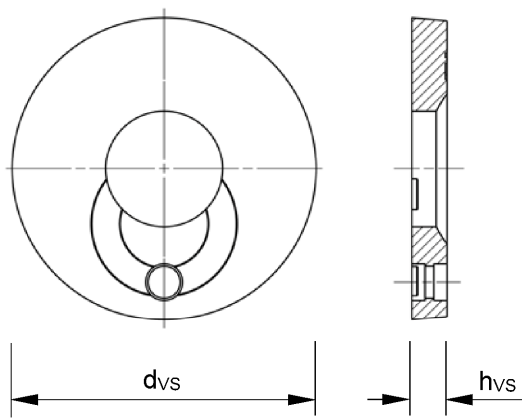

Spherical washer

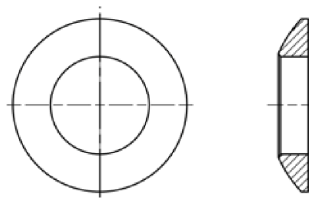

Hilti metal expansion anchor HST, HST-R, HST-HCR, HST3, HST3-R

Product description
Dimensions

Annex A10

Specifications of intended use

Base materials:

- Compacted reinforced or unreinforced normal weight concrete without fibres according to EN 206:2013 + A1:2016.
- Strength classes C20/25 to C50/60 according to EN 206:2013 + A1:2016.
- Cracked and non-cracked concrete

Use conditions (Environmental conditions):

- Hilti metal expansion anchor HST and HST3 made of galvanized steel:
Structures subject to dry internal conditions
- Hilti metal expansion anchor HST-R and HST3-R made of stainless steel A4:
Structures subject to dry internal conditions and also in structures subject to external atmospheric exposure (including industrial and marine environment), or exposure in permanently damp internal conditions, if no particular aggressive conditions exist. Such particular aggressive conditions are e.g. permanent, alternating immersion in seawater or the splash zone of seawater, chloride atmosphere of indoor swimming pools or atmosphere with extreme chemical pollution (e.g. in desulphurization plants or road tunnels where de-icing materials are used).
- Hilti metal expansion anchor HST-HCR made of high corrosion resistance steel:
Structures subject to dry internal conditions and also in structures subject to external atmospheric exposure, in permanently damp internal conditions or in other particular aggressive conditions. Such particular aggressive conditions are e.g. permanent, alternating immersion in seawater or the splash zone of seawater, chloride atmosphere of indoor swimming pools or atmosphere with chemical pollution (e.g. in desulphurization plants or road tunnels where de-icing materials are used).

Design:

- Anchorages are designed under the responsibility of an engineer experienced in anchorages and concrete work.
- Verifiable calculation notes and drawings are prepared taking account of the loads to be anchored. The position of the anchor is indicated on the design drawings (e. g. position of the anchor relative to reinforcement or to supports, etc.).
- Anchorages are designed in accordance with:
EN 1992-4:2018 and EOTA Technical Report TR 055, 12/2016
- In case of requirements to resistance to fire local spalling of the concrete cover must be avoided.

Hilti metal expansion anchor HST, HST-R, HST-HCR, HST3, HST3-R

Specifications of intended use

Annex B1

Installation:

- Anchor installation carried out by appropriately qualified personnel and under the supervision of the person responsible for technical matters of the site.
- The anchor may only be set once.
- Overhead applications are permitted.

Table B1: Drilling technique HST, HST-R and HST-HCR

HST, HST-R and HST-HCR	M8	M10	M12	M16	M20 ¹⁾	M24 ¹⁾
Hammer drilling (HD) 	✓	✓	✓	✓	✓	✓

¹⁾ Only HST and HST-R

Table B2: Drilling technique HST3 and HST3-R







HST3, HST3-R	M8	M10	M12	M16	M20	M24
Hammer drilling (HD) 	✓	✓	✓	✓	✓	✓
Diamond coring (DD) with <ul style="list-style-type: none"> • DD EC-1 coring tool and DD-C ... TS/TL core bits or DD-C ... T2/T4 core bits  • DD 30-W coring tool and C+ ... SPX-T (abrasive) core bits 	✓	✓	✓	✓	✓	✓
Hammer drilling with Hilti hollow drill bit TE-CD/YD ... drilling system (HDB) 	-	-	✓	✓	✓	✓

Table B3: Drill hole cleaning

Manual cleaning (MC): Hilti hand pump for blowing out boreholes 	
Compressed air cleaning (CAC): Air nozzle with an orifice opening of 3,5 mm in diameter 	
Automated cleaning (AC): Cleaning is performed during drilling with Hilti TE-CD and TE-YD drilling system including vacuum cleaner 	

Hilti metal expansion anchor HST, HST-R, HST-HCR, HST3, HST3-R

Specifications of intended use

Annex B2

Table B4: Methods for application of torque moment HST, HST-R and HST-HCR

HST, HST-R and HST-HCR	M8	M10	M12	M16	M20 ¹⁾	M24 ¹⁾
Torque wrench 	✓	✓	✓	✓	✓	✓

¹⁾ Only HST and HST-R

Table B5: Methods for application of torque moment HST3 and HST3-R



HST3, HST3-R	M8	M10	M12	M16	M20	M24
Torque wrench 	✓	✓	✓	✓	✓	✓
Machine torquing with Hilti SIW 6AT-A22 impact wrench and SI-AT-A22 adaptive torque module 	✓	✓	✓	-	-	-

Table B6: Overview use and performance categories HST, HST-R and HST-HCR

Anchorage subject to:	HST, HST-R, HST-HCR
Static and quasi static loading	M8 to M24 (HST and HST-R) M8 to M16 (HST-HCR) Table : C1, C3, C5
Seismic performance category C1/C2	M10 to M16 (HST and HST-R) Table : C7, C9, C11, C12, C15, C16
Static and quasi static loading under fire exposure	M8 to M24 Table : C19, C21

Table B7: Overview use and performance categories HST3 and HST3-R

Anchorage subject to:	HST3, HST3-R
Static and quasi static loading	M10 to M16 (for $h_{ef,1}$) M8 to M24 (for $h_{ef,2}$) Table : C2, C4, C6
Seismic performance category C1/C2	M8 to M20 (for $h_{ef,2}$) M12 (for $h_{ef,1}$) Table : C8, C10, C13, C14, C17, C18
Static and quasi static loading under fire exposure	M10 to M16 (for $h_{ef,1}$) M8 to M24 (for $h_{ef,2}$) Table : C20, C22

Hilti metal expansion anchor HST, HST-R, HST-HCR, HST3, HST3-R

Specifications of intended use

Annex B3

Table B8: Installation parameters for HST, HST-R and HST-HCR

HST, HST-R, HST-HCR			M8	M10	M12	M16	M20 ¹⁾	M24 ¹⁾
Nominal diameter of drill bit	d_0	[mm]	8	10	12	16	20	24
Cutting diameter of drill bit	$d_{cut} \leq$	[mm]	8,45	10,45	12,50	16,50	20,55	24,55
Drill hole depth	$h_1 \geq$	[mm]	65	80	95	115	140	170
Effective embedment depth	h_{ef}	[mm]	47	60	70	82	101	125
Thread engagement length	h_{nom}	[mm]	55	69	80	95	117	143
Maximum diameter of clearance hole in the fixture ²⁾	d_f	[mm]	9	12	14	18	22	26
Installation torque moment	T_{inst}	[Nm]	20	45	60	110	240	300
Maximum thickness of fixture	$t_{fix,max} \leq$	[mm]	195	200	200	235	305	330
Width across flats	SW	[mm]	13	17	19	24	30	36

¹⁾ Only HST and HST-R

²⁾ For bigger clearance holes in the fixture see ETAG 001 Annex C Chapter 4.2.2.1

Hilti metal expansion anchor HST, HST-R, HST-HCR, HST3, HST3-R

Intended use
Installation parameters

Annex B4

Table B9: Installation parameters for HST3 and HST3-R

HST3, HST3-R			M8	M10	M12	M16	M20	M24
Nominal diameter of drill bit	d_0	[mm]	8	10	12	16	20	24
Cutting diameter of drill bit for hammer drilling	$d_{cut} \leq$	[mm]	8,45	10,45	12,50	16,50	20,55	24,55
Drill hole depth ¹⁾	$h_{1,1} \geq$	[mm]	-	53	68	86	-	-
Effective embedment depth	$h_{ef,1}$	[mm]	-	40	50	65	-	-
Thread engagement length	$h_{nom,1}$	[mm]	-	48	60	78	-	-
Drill hole depth ¹⁾	$h_{1,2} \geq$	[mm]	59	73	88	106	124	151
Effective embedment depth	$h_{ef,2}$	[mm]	47	60	70	85	101	125
Thread engagement length	$h_{nom,2}$	[mm]	54	68	80	98	116	143
Maximum diameter of clearance hole in the fixture ²⁾	d_f	[mm]	9	12	14	18	22	26
Installation torque moment	T_{inst}	[Nm]	20	45	60	110	180	300
Maximum thickness of fixture	$t_{fix,max}$	[mm]	195	220	270	370	310	330
Width across flats	SW	[mm]	13	17	19	24	30	36

¹⁾ In case of diamond drilling + 5 mm for M8 to M10 and + 2 mm for M12 to M24

²⁾ For bigger clearance holes in the fixture see ETAG 001 Annex C Chapter 4.2.2.1

Hilti metal expansion anchor HST, HST-R, HST-HCR, HST3, HST3-R

Intended use
Installation parameters

Annex B5

HST, HST-R and HST-HCR

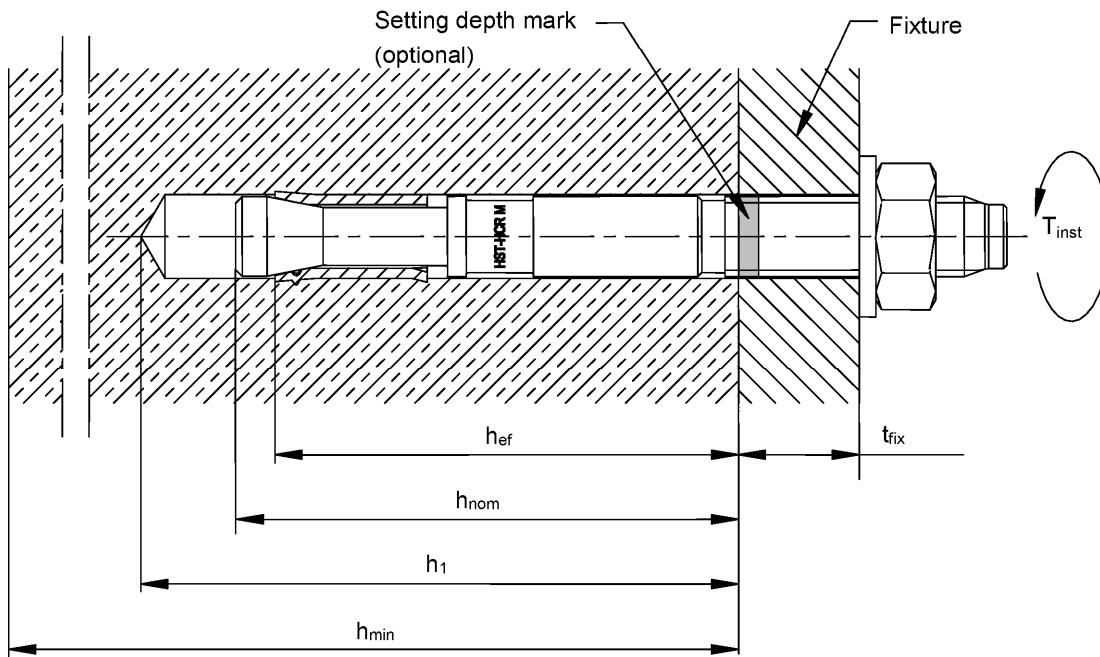

HST3 and HST3-R (standard embedment depth)

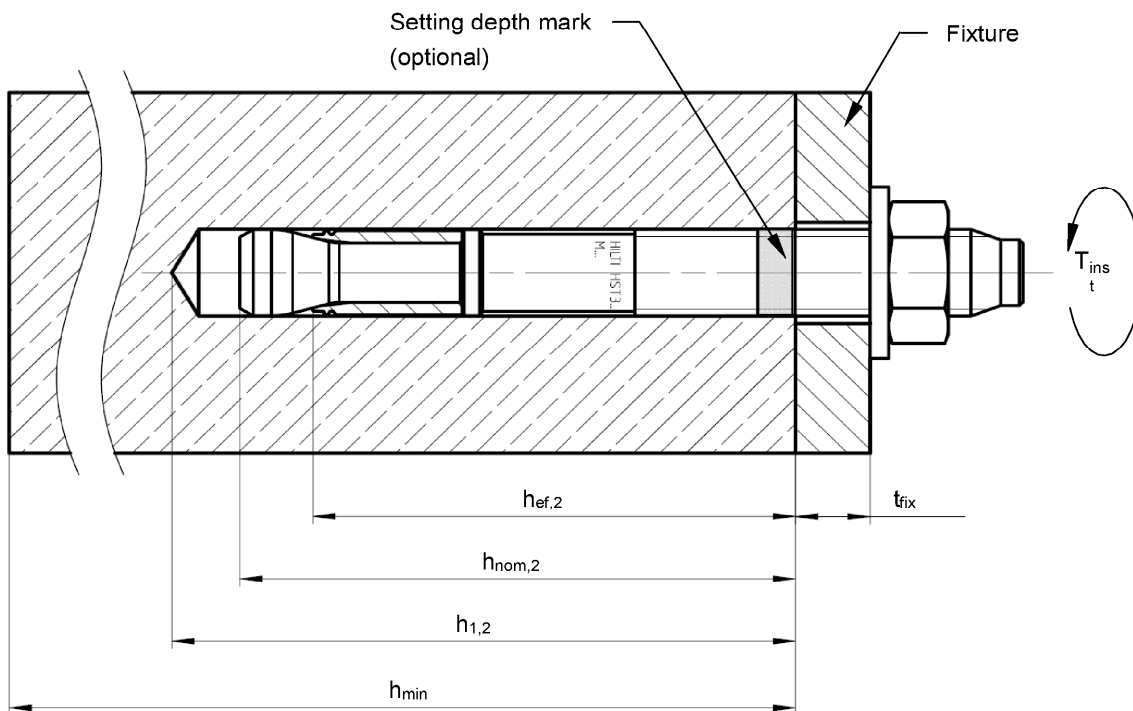

Electronic copy of the ETA by DIBt: ETA-98/0001

Hilti metal expansion anchor HST, HST-R, HST-HCR, HST3, HST3-R

Intended Use
Installation parameters

Annex B6

HST3 and HST3-R (shallow embedment depth)

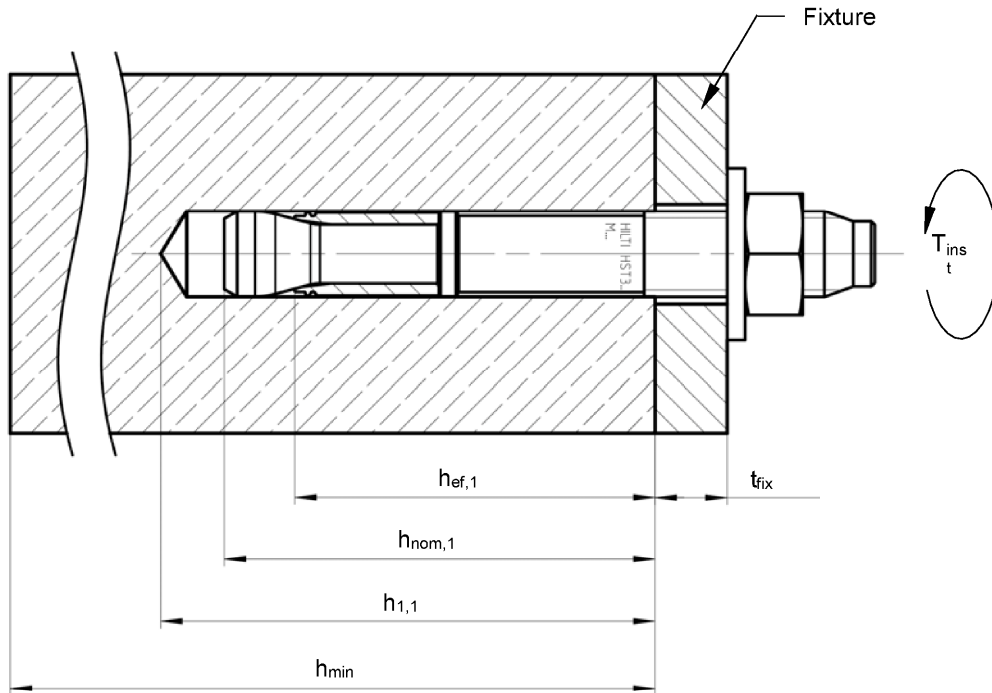

HST3 and HST3-R with Filling Set to fill the annular gap between anchor and fixture

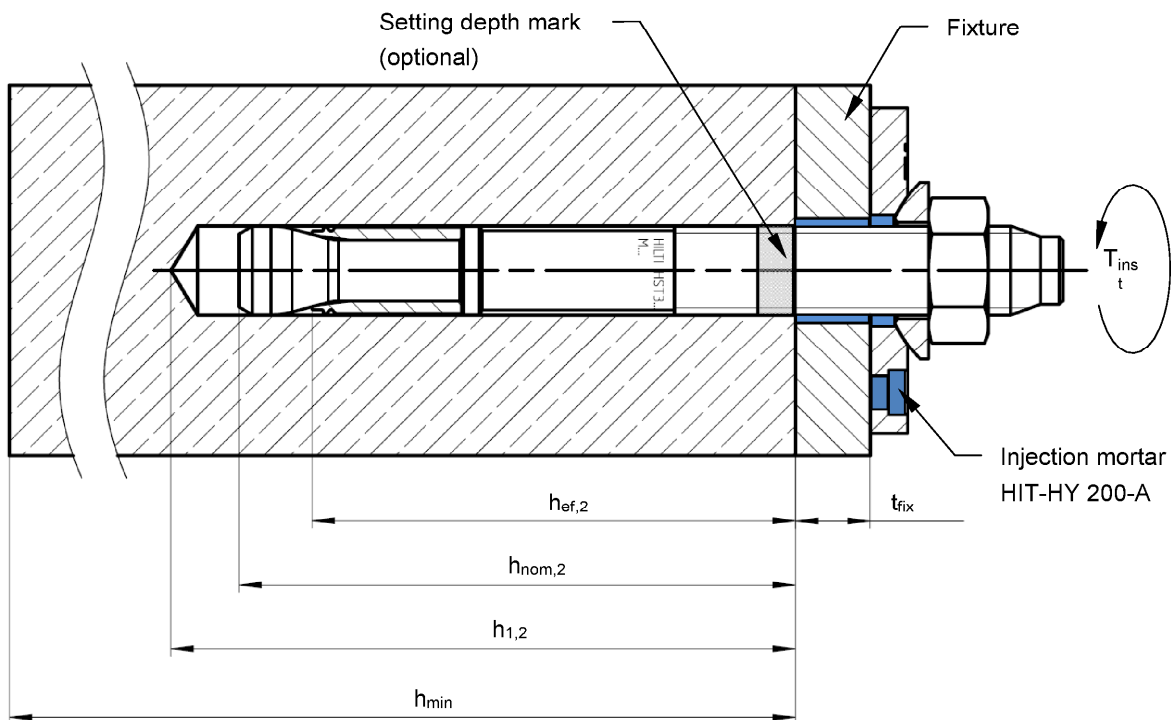

Electronic copy of the ETA by DIBt: ETA-98/0001

Hilti metal expansion anchor HST, HST-R, HST-HCR, HST3, HST3-R

Intended Use
Installation parameters

Annex B7

Table B10: Minimum spacing and edge distance for HST, HST-R and HST-HCR

		M8	M10	M12	M16	M20 ¹⁾	M24 ¹⁾
Minimum thickness of concrete member	h_{min} [mm]	100	120	140	160	200	250
Effective embedment depth	h_{ef} [mm]	47	60	70	82	101	125
Cracked concrete							
HST							
Minimum spacing ²⁾	s_{min} [mm]	40	55	60	70	100	125
	for $c \geq$ [mm]	50	70	75	100	160	180
Minimum edge distance ²⁾	c_{min} [mm]	45	55	55	70	100	125
	for $s \geq$ [mm]	50	90	120	150	225	240
HST-R							
Minimum spacing ²⁾	s_{min} [mm]	40	55	60	70	100	125
	for $c \geq$ [mm]	50	65	75	100	130	130
Minimum edge distance ²⁾	c_{min} [mm]	45	50	55	60	100	125
	for $s \geq$ [mm]	50	90	110	160	160	140
HST-HCR							
Minimum spacing ²⁾	s_{min} [mm]	40	55	60	70	-	-
	for $c \geq$ [mm]	50	70	75	100	-	-
Minimum edge distance ²⁾	c_{min} [mm]	45	50	55	60	-	-
	for $s \geq$ [mm]	50	90	110	160	-	-

¹⁾ Only HST and HST-R

²⁾ Linear interpolation for s_{min} and c_{min} allowed

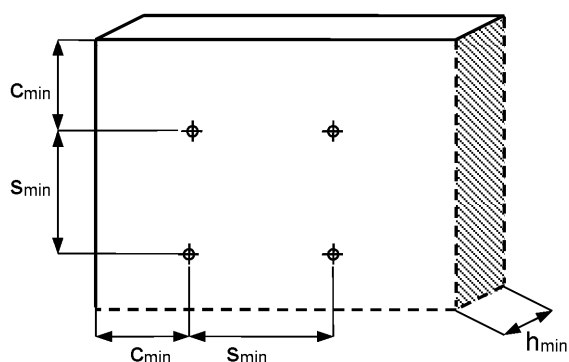

Hilti metal expansion anchor HST, HST-R, HST-HCR, HST3, HST3-R

Intended Use
Minimum spacing and minimum edge distance

Annex B8

Table B10 continued

		M8	M10	M12	M16	M20 ¹⁾	M24 ¹⁾
Minimum thickness of concrete member	h_{min} [mm]	100	120	140	160	200	250
Effective embedment depth	h_{ef} [mm]	47	60	70	82	101	125
Non-cracked concrete							
HST							
Minimum spacing ²⁾	s_{min} [mm]	60	55	60	70	100	125
	for $c \geq$ [mm]	50	80	85	110	225	255
Minimum edge distance ²⁾	c_{min} [mm]	50	55	55	85	140	170
	for $s \geq$ [mm]	60	115	145	150	270	295
HST-R							
Minimum spacing ²⁾	s_{min} [mm]	60	55	60	70	100	125
	for $c \geq$ [mm]	60	70	80	110	195	205
Minimum edge distance ²⁾	c_{min} [mm]	60	50	55	70	140	150
	for $s \geq$ [mm]	60	115	145	160	210	235
HST-HCR							
Minimum spacing ²⁾	s_{min} [mm]	60	55	60	70	-	-
	for $c \geq$ [mm]	50	70	80	110	-	-
Minimum edge distance ²⁾	c_{min} [mm]	60	55	55	70	-	-
	for $s \geq$ [mm]	60	115	145	160	-	-

¹⁾ Only HST and HST-R

²⁾ Linear interpolation for s_{min} and c_{min} allowed

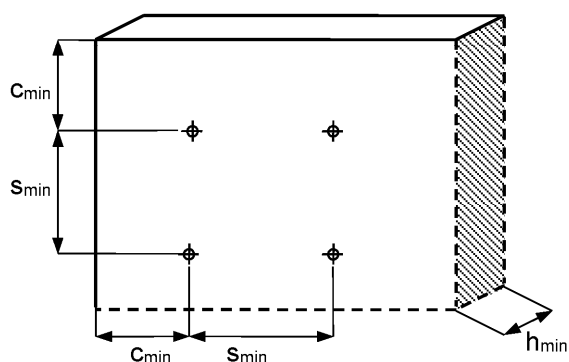

Hilti metal expansion anchor HST, HST-R, HST-HCR, HST3, HST3-R

Intended Use
Minimum spacing and minimum edge distance

Annex B9

Table B11: Minimum spacing and edge distance for HST3 and HST3-R

		M8	M10	M12	M16	M20	M24
Minimum thickness of concrete member	h_{min} [mm]	100	120	140	160	200	250
Effective embedment depth	$h_{ef,2}$ [mm]	47	60	70	85	101	125
Cracked concrete							
HST3							
Minimum spacing ¹⁾	s_{min} [mm]	35	40	50	65	90	125
	for $c \geq$ [mm]	50	55	70	95	130	180
Minimum edge distance ¹⁾	c_{min} [mm]	40	45	55	65	80	125
	for $s \geq$ [mm]	50	80	110	150	180	240
HST3-R							
Minimum spacing ¹⁾	s_{min} [mm]	35	40	50	65	90	125
	for $c \geq$ [mm]	50	55	70	95	130	130
Minimum edge distance ¹⁾	c_{min} [mm]	40	45	55	65	80	125
	for $s \geq$ [mm]	50	80	110	150	180	140

¹⁾ Linear interpolation for s_{min} and c_{min} allowed

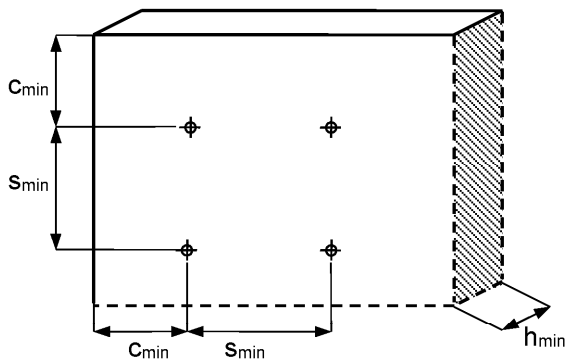

Hilti metal expansion anchor HST, HST-R, HST-HCR, HST3, HST3-R

Intended Use
Minimum spacing and minimum edge distance

Annex B10

Table B11 continued

		M8	M10	M12	M16	M20	M24
Minimum thickness of concrete member	h_{min} [mm]	100	120	140	160	200	250
Effective embedment depth	$h_{ef,2}$ [mm]	47	60	70	85	101	125
Non-cracked concrete							
HST3							
Minimum spacing ¹⁾	s_{min} [mm]	35	40	60	65	90	125
	for $c \geq$ [mm]	50	60	70	95	130	255
Minimum edge distance ¹⁾	c_{min} [mm]	40	50	55	65	80	170
	for $s \geq$ [mm]	50	90	110	150	180	295
HST3-R							
Minimum spacing ¹⁾	s_{min} [mm]	35	40	60	65	90	125
	for $c \geq$ [mm]	50	60	70	95	130	205
Minimum edge distance ¹⁾	c_{min} [mm]	40	50	55	65	80	150
	for $s \geq$ [mm]	50	90	110	150	180	235

¹⁾ Linear interpolation for s_{min} and c_{min} allowed

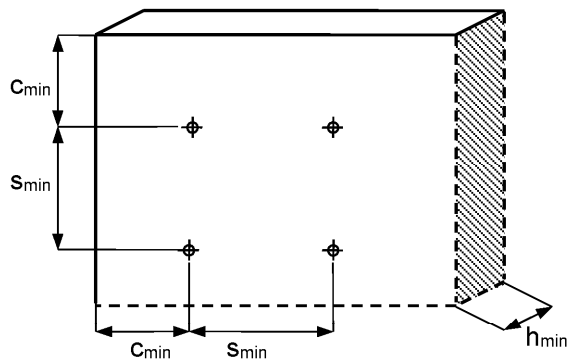

Hilti metal expansion anchor HST, HST-R, HST-HCR, HST3, HST3-R

Intended Use
Minimum spacing and minimum edge distance

Annex B11

English translation prepared by DIBt

Table B11 continued

		M8	M10	M12	M16	M20	M24
Minimum thickness of concrete member	h_{min} [mm]	80	100	120	140	160	-
Effective embedment depth	$h_{ef,2}$ [mm]	47	60	70	85	101	-
Cracked concrete							
HST3 and HST3-R							
Minimum spacing ¹⁾	s_{min} [mm]	35	40	50	80	120	-
	for $c \geq$ [mm]	50	100	90	130	180	-
Minimum edge distance ¹⁾	c_{min} [mm]	40	60	60	65	120	-
	for $s \geq$ [mm]	50	90	120	180	180	-
Non-cracked concrete							
HST3 and HST3-R							
Minimum spacing ¹⁾	s_{min} [mm]	35	40	50	80	120	-
	for $c \geq$ [mm]	55	100	100	130	180	-
Minimum edge distance ¹⁾	c_{min} [mm]	40	60	60	65	120	-
	for $s \geq$ [mm]	60	90	120	180	180	-

¹⁾ Linear interpolation for s_{min} and c_{min} allowed

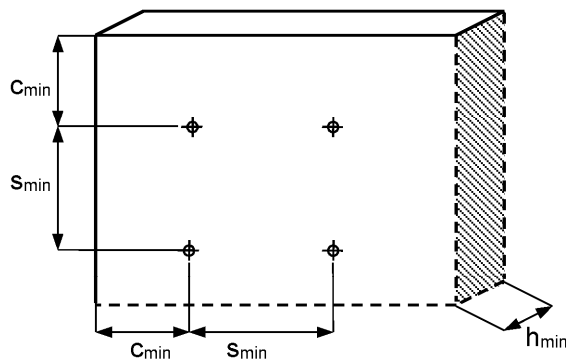

Hilti metal expansion anchor HST, HST-R, HST-HCR, HST3, HST3-R

Intended Use
Minimum spacing and minimum edge distance

Annex B12

Table B11 continued

		M8	M10	M12	M16	M20	M24
Minimum thickness of concrete member	h_{min} [mm]	-	80	100	120	-	-
Effective embedment depth	$h_{ef,1}$ [mm]	-	40	50	65	-	-
Cracked concrete							
HST3 and HST3-R							
Minimum spacing ¹⁾	s_{min} [mm]	-	40	50	65	-	-
	for $c \geq$ [mm]	-	90	105	130	-	-
Minimum edge distance ¹⁾	c_{min} [mm]	-	45	55	65	-	-
	for $s \geq$ [mm]	-	180	210	240	-	-
Non-cracked concrete							
HST3 and HST3-R							
Minimum spacing ¹⁾	s_{min} [mm]	-	50	55	75	-	-
	for $c \geq$ [mm]	-	95	110	140	-	-
Minimum edge distance ¹⁾	c_{min} [mm]	-	50	60	65	-	-
	for $s \geq$ [mm]	-	190	215	240	-	-

¹⁾ Linear interpolation for s_{min} and c_{min} allowed

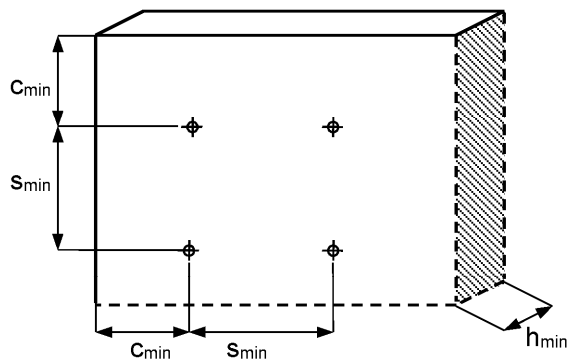

Hilti metal expansion anchor HST, HST-R, HST-HCR, HST3, HST3-R

Intended Use
Minimum spacing and minimum edge distance

Annex B13

Installation instruction HST, HST-R and HST-HCR

Hole drilling and cleaning

- a) Hammer drilling (HD):
M8 to M24

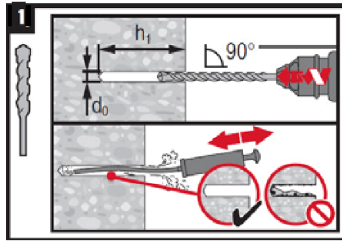

Anchor setting

- a) Hammer setting:
M8 to M24

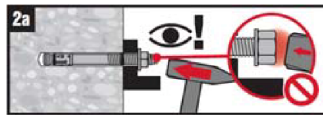

- b) Machine setting (setting tool):
M8 to M24

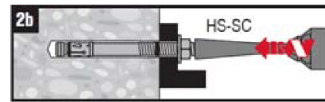

Check setting

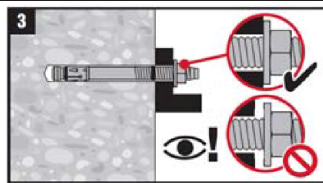

Anchor torquing

- a) Torque wrench:
M8 to M24

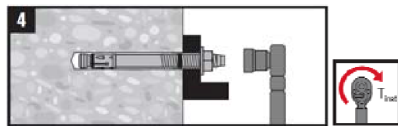

Hilti metal expansion anchor HST, HST-R, HST-HCR, HST3, HST3-R

Intended Use
Installation instructions

Annex B14

Installation instruction HST3 and HST3-R

Hole drilling and cleaning

a) Hammer drilling (HD):
M8 to M24

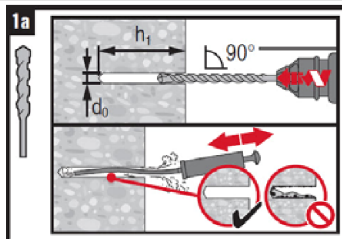

b) Diamond coring (DD):
M8 to M24

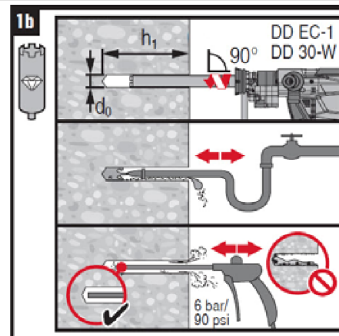

c) Hammer drilling with Hilti hollow drill bit (HDB):
M12 to M24

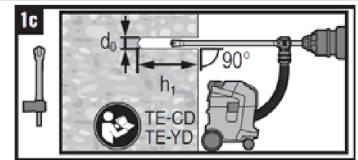

Anchor setting

a) Hammer setting:

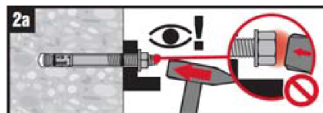

b) Machine setting (setting tool):

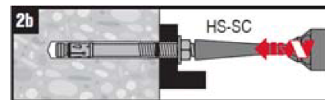

Check setting

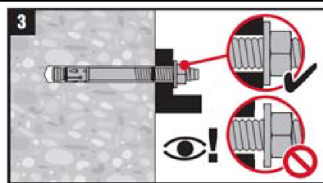

Anchor torquing

a) Torque wrench:
M8 to M24

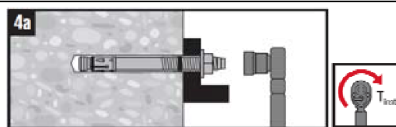

b) Machine torquing:
M8 to M12

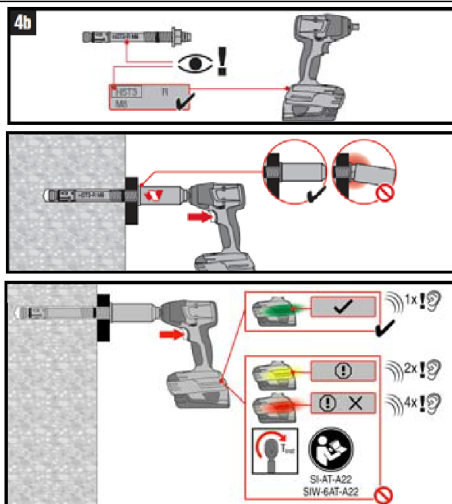

Hilti metal expansion anchor HST, HST-R, HST-HCR, HST3, HST3-R

Intended Use
Installation instructions

Annex B15

Installation instruction HST3 and HST3-R with Filling Set

Installation of sealing washer

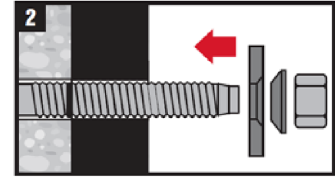
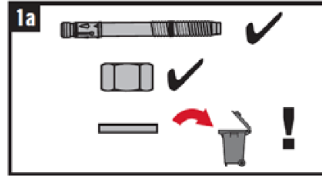
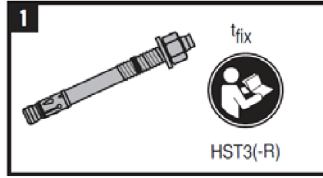

Anchor torquing

a) Torque wrench:
M8 to M20

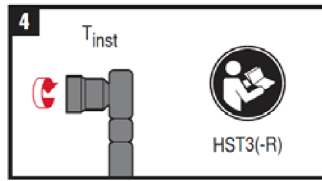
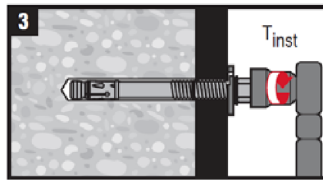

Installation of counter nut

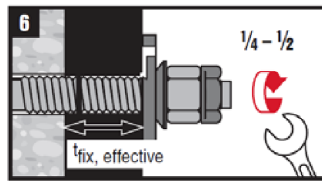
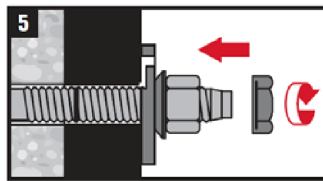

Injection of mortar

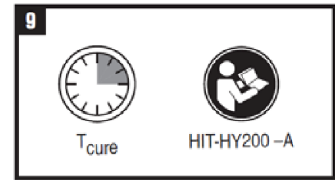
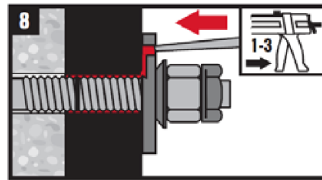
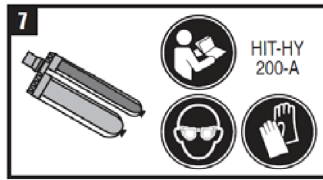

Hilti metal expansion anchor HST, HST-R, HST-HCR, HST3, HST3-R

Intended Use
Installation instructions

Annex B16

Table C1: Characteristic tension resistance for Hilti metal expansion anchor HST, HST-R and HST-HCR in cracked and non-cracked concrete

			M8	M10	M12	M16	M20 ¹⁾	M24 ¹⁾	
Steel failure									
HST									
Characteristic resistance	$N_{Rk,s}$	[kN]	19,0	32,0	45,0	76,0	117,0	127,0	
Partial safety factor	γ_{Ms} ²⁾	[-]	1,50					1,41	
HST-R									
Characteristic resistance	$N_{Rk,s}$	[kN]	17,0	28,0	40,0	69,0	109,0	156,0	
Partial safety factor	γ_{Ms} ²⁾	[-]	1,50			1,56	1,73		
HST-HCR									
Characteristic resistance	$N_{Rk,s}$	[kN]	19,4	32,3	45,7	84,5	-	-	
Partial safety factor	γ_{Ms} ²⁾	[-]	1,50				-	-	
Pullout failure									
HST									
Characteristic resistance in cracked concrete C20/25	$N_{Rk,p}$	[kN]	5,0	9,0	12,0	20,0	30,0	40,0	
Characteristic resistance in non-cracked concrete C20/25	$N_{Rk,p}$	[kN]	9,0	16,0	20,0	35,0	50,0	60,0	
Installation safety factor	γ_{inst}	[-]	1,20	1,00					
HST-R									
Characteristic resistance in cracked concrete C20/25	$N_{Rk,p}$	[kN]	5,0	9,0	12,0	25,0	30,0	40,0	
Characteristic resistance in non-cracked concrete C20/25	$N_{Rk,p}$	[kN]	9,0	16,0	20,0	35,0	50,0	60,0	
Installation safety factor	γ_{inst}	[-]	1,00						
HST-HCR									
Characteristic resistance in cracked concrete C20/25	$N_{Rk,p}$	[kN]	5,0	9,0	12,0	25,0	-	-	
Characteristic resistance in cracked concrete C50/60	$N_{Rk,p}$	[kN]	9,0	16,0	20,0	35,0	-	-	
Installation safety factor	γ_{inst}	[-]	1,00				-	-	

¹⁾ Only HST and HST-R

²⁾ In absence of other national regulations

Hilti metal expansion anchor HST, HST-R, HST-HCR, HST3, HST3-R

Performances

Characteristic values of resistance under tension loading in cracked and non-cracked concrete

Annex C1

Table C1 continued

			M8	M10	M12	M16	M20 ¹⁾	M24 ¹⁾
Pullout failure								
HST, HST-R and HST-HCR								
Increasing factor for cracked and non-cracked concrete	ψ_c	C20/25	1,00					
	ψ_c	C30/37	1,22					
	ψ_c	C40/50	1,41					
	ψ_c	C50/60	1,55					
Concrete cone and splitting failure								
HST, HST-R and HST-HCR								
Effective embedment depth	h_{ef}	[mm]	47	60	70	82	101	125
Installation safety factor	γ_{inst}	[-]	1,20	1,00				
Factor for cracked concrete	$k_1 = k_{cr,N}$	[-]	7,7					
Factor for non-cracked concrete	$k_1 = k_{ucr,N}$	[-]	11,0					
Spacing	$s_{cr,N}$ $s_{cr,sp}$	[mm]	3 h_{ef}					
Edge distance	$c_{cr,N}$ $c_{cr,sp}$	[mm]	1,5 h_{ef}					

¹⁾ Only HST and HST-R

Hilti metal expansion anchor HST, HST-R, HST-HCR, HST3, HST3-R

Performances

Characteristic values of resistance under tension loading in cracked and non-cracked concrete

Annex C2

Table C2: Characteristic tension resistance for Hilti metal expansion anchor HST3 and HST3-R in cracked and non-cracked concrete

			M8	M10	M12	M16	M20	M24	
Steel failure									
HST3									
Characteristic resistance	$N_{Rk,s}$	[kN]	19,7	32,5	45,1	76,0	124,2	127,0	
Partial safety factor	$\gamma_{Ms}^{1)}$	[-]	1,40					1,41	
HST3-R									
Characteristic resistance	$N_{Rk,s}$	[kN]	17,7	28,7	42,5	69,4	115,8	156,0	
Partial safety factor	$\gamma_{Ms}^{1)}$	[-]	1,40					1,56	
Pullout failure									
HST3									
Effective embedment depth	$h_{ef,2}$	[mm]	47	60	70	85	101	125	
Characteristic resistance in cracked concrete C20/25	$N_{Rk,p}$	[kN]	8,0	15,0	20,0	2)	2)	40,0	
Characteristic resistance in non-cracked concrete C20/25	$N_{Rk,p}$	[kN]	12,0	22,0	25,0	2)	2)	60,0	
Installation safety factor	γ_{inst}	[-]	1,00						
HST3-R									
Effective embedment depth	$h_{ef,2}$	[mm]	47	60	70	85	101	125	
Characteristic resistance in cracked concrete C20/25	$N_{Rk,p}$	[kN]	8,5	15,0	20,0	2)	2)	40,0	
Characteristic resistance in non-cracked concrete C20/25	$N_{Rk,p}$	[kN]	12,0	22,0	25,0	2)	2)	60,0	
Installation safety factor	γ_{inst}	[-]	1,00						
HST3 and HST3-R									
Effective embedment depth	$h_{ef,1}$	[mm]	-	40	50	65	-	-	
Characteristic resistance in cracked concrete C20/25	$N_{Rk,p}$	[kN]	-	2)	2)	2)	-	-	
Characteristic resistance in non-cracked concrete C20/25	$N_{Rk,p}$	[kN]	-	2)	2)	2)	-	-	
Installation safety factor	γ_{inst}	[-]	1,00						

¹⁾ In absence of other national regulations

²⁾ Pullout failure not decisive

Hilti metal expansion anchor HST, HST-R, HST-HCR, HST3, HST3-R

Performances

Characteristic values of resistance under tension loading in cracked and non-cracked concrete

Annex C3

Table C2 continued

			M8	M10	M12	M16	M20	M24
Pull out Failure								
HST3 und HST3-R								
Increasing factor for cracked and non-cracked concrete	ψ_c	C20/25	1,00					
	ψ_c	C30/37	1,22					
	ψ_c	C40/50	1,41					
	ψ_c	C50/60	1,55					
Concrete cone and splitting failure								
HST3 und HST3-R								
Effective embedment depth	$h_{ef,2}$	[mm]	47	60	70	85	101	125
Installation safety factor	γ_{inst}	[-]	1,00					
Factor for cracked concrete	$k_1 = k_{Cr,N}$	[-]	7,7					
Factor for non-cracked concrete	$k_1 = k_{Ucr,N}$	[-]	11,0					
Spacing	$s_{cr,N}$	[mm]	3 h_{ef}					
Edge distance	$c_{cr,N}$	[mm]	1,5 h_{ef}					
Spacing	$s_{cr,sp}$	[mm]	3 h_{ef}				3,8 h_{ef}	3 h_{ef}
Edge distance	$c_{cr,sp}$	[mm]	1,5 h_{ef}				1,9 h_{ef}	1,5 h_{ef}
HST3 und HST3-R								
Effective embedment depth	$h_{ef,1}$	[mm]	-	40	50	65	-	-
Installation safety factor	γ_{inst}	[-]	1,00					
Factor for cracked concrete	$k_1 = k_{Cr,N}$	[-]	-	7,7			-	-
Factor for non-cracked concrete	$k_1 = k_{Ucr,N}$	[-]	-	11,0			-	-
Spacing	$s_{cr,N}$	[mm]	-	3 h_{ef}			-	-
Edge distance	$c_{cr,N}$	[mm]	-	1,5 h_{ef}			-	-
Spacing	$s_{cr,sp}$	[mm]	-	4,2 h_{ef}	3,6 h_{ef}	3,2 h_{ef}	-	-
Edge distance	$c_{cr,sp}$	[mm]	-	2,1 h_{ef}	1,8 h_{ef}	1,6 h_{ef}	-	-

Hilti metal expansion anchor HST, HST-R, HST-HCR, HST3, HST3-R

Performances

Characteristic values of resistance under tension loading in cracked and non-cracked concrete

Annex C4

Table C3: Characteristic shear resistance for Hilti metal expansion anchor HST, HST-R and HST-HCR in cracked and non-cracked concrete

			M8	M10	M12	M16	M20 ¹⁾	M24 ¹⁾	
Steel failure without lever arm									
HST									
Characteristic resistance	$V_{Rk,s}$	[kN]	14,0	23,5	35,0	55,0	84,0	94,0	
Partial safety factor	γ_{Ms} ²⁾	[-]	1,25					1,50	
Ductility factor	k_7	[-]	1,00						
HST-R									
Characteristic resistance	$V_{Rk,s}$	[kN]	13,0	20,0	30,0	50,0	80,0	115,0	
Partial safety factor	γ_{Ms} ²⁾	[-]	1,25			1,30	1,44		
Ductility factor	k_7	[-]	1,00						
HST-HCR									
Characteristic resistance	$V_{Rk,s}$	[kN]	13,0	20,0	30,0	55,0	-	-	
Partial safety factor	γ_{Ms} ²⁾	[-]	1,25				-	-	
Ductility factor	k_7	[-]	1,00			-	-		
Steel failure with lever arm									
HST									
Characteristic resistance	$M^0_{Rk,s}$	[Nm]	30	60	105	240	454	595	
Partial safety factor	γ_{Ms} ²⁾	[-]	1,25					1,50	
HST-R									
Characteristic resistance	$M^0_{Rk,s}$	[Nm]	27	53	92	216	422	730	
Partial safety factor	γ_{Ms} ²⁾	[-]	1,25			1,30	1,44		
HST-HCR									
Characteristic resistance	$M^0_{Rk,s}$	[Nm]	30	60	105	266	-	-	
Partial safety factor	γ_{Ms} ²⁾	[-]	1,25				-	-	

¹⁾ Only HST and HST-R

²⁾ In absence of other national regulations

Hilti metal expansion anchor HST, HST-R, HST-HCR, HST3, HST3-R

Performances

Characteristic values of resistance under shear loading in cracked and non-cracked concrete

Annex C5

Table C3 continued

			M8	M10	M12	M16	M20 ¹⁾	M24 ¹⁾
Concrete pryout failure								
HST, HST-R and HST-HCR								
Installation safety factor	γ_{inst}	[-]	1,00					
Pryout factor	k_8	[-]	2,0	2,0	2,2	2,5	2,5	2,5
Concrete edge failure								
HST, HST-R and HST-HCR								
Effective length of anchor in shear loading	l_f	[mm]	47	60	70	82	101	125
Diameter of anchor	d_{nom}	[mm]	8	10	12	16	20	24
Installation safety factor	γ_{inst}	[-]	1,00					

¹⁾ Only HST and HST-R

Hilti metal expansion anchor HST, HST-R, HST-HCR, HST3, HST3-R

Performances

Characteristic values of resistance under shear loading in cracked and non-cracked concrete

Annex C6

Table C4: Characteristic shear resistance for Hilti metal expansion anchor HST3 and HST3-R in cracked and non-cracked concrete

			M8	M10	M12	M16	M20	M24
Steel failure without lever arm								
HST3								
Effective embedment depth	$h_{ef,2}$	[mm]	47	60	70	85	101	125
Characteristic resistance	$V_{Rk,s}$	[kN]	13,8	23,6	35,4	55,3	83,9	94,0
Characteristic resistance using Filling Set	$V_{Rk,s}$	[kN]	16,6	25,8	39,0	60,9	100,4	-
Partial safety factor	$\gamma_{Ms}^{1)}$	[-]	1,25					1,50
Ductility factor	k_7	[-]	1,00					
HST3-R								
Effective embedment depth	$h_{ef,2}$	[mm]	47	60	70	85	101	125
Characteristic resistance	$V_{Rk,s}$	[kN]	15,7	25,3	36,7	63,6	97,2	115,0
Characteristic resistance using Filling Set	$V_{Rk,s}$	[kN]	19,5	28,4	44,3	70,2	102,7	-
Partial safety factor	$\gamma_{Ms}^{1)}$	[-]	1,25					1,30
Ductility factor	k_7	[-]	1,00					
HST3								
Effective embedment depth	$h_{ef,1}$	[mm]	-	40	50	65	-	-
Characteristic resistance	$V_{Rk,s}$	[kN]	-	21,9	34,0	54,5	-	-
Partial safety factor	$\gamma_{Ms}^{1)}$	[-]	-	1,25			-	-
Ductility factor	k_7	[-]	-	1,00			-	-
HST3-R								
Effective embedment depth	$h_{ef,1}$	[mm]	-	40	50	65	-	-
Characteristic resistance	$V_{Rk,s}$	[kN]	-	25,6	31,1	48,6	-	-
Partial safety factor	$\gamma_{Ms}^{1)}$	[-]	-	1,25			-	-
Ductility factor	k_7	[-]	-	1,00			-	-

¹⁾ In absence of other national regulations

Hilti metal expansion anchor HST, HST-R, HST-HCR, HST3, HST3-R

Performances

Characteristic values of resistance under shear loading in cracked and non-cracked concrete

Annex C7

Table C4 continued

		M8	M10	M12	M16	M20	M24
Steel failure with lever arm							
HST3							
Characteristic resistance	$M_{Rk,s}^0$ [Nm]	30	60	105	240	457	595
Partial safety factor	$\gamma_{Ms}^{1)}$ [-]	1,25					1,50
HST3-R							
Characteristic resistance	$M_{Rk,s}^0$ [Nm]	27	53	93	216	425	730
Partial safety factor	$\gamma_{Ms}^{1)}$ [-]	1,25					1,30
Concrete pryout failure							
HST3 and HST3-R							
Effective embedment depth	$h_{ef,2}$ [mm]	47	60	70	85	101	125
Installation safety factor	γ_{inst} [-]	1,00					
Pryout factor	k_8 [-]	2,62	2,67	2,78	3,41	3,20	2,50
HST3 and HST3-R							
Effective embedment depth	$h_{ef,1}$ [mm]	-	40	50	65	-	-
Installation safety factor	γ_{inst} [-]	1,00					
Pryout factor	k_8 [-]	-	2,67	2,78	3,41	-	-
Concrete edge failure							
HST3 and HST3-R							
Effective length of anchor in shear loading	$l_{f,2}$ [mm]	47	60	70	85	101	125
Effective length of anchor in shear loading with shallow embedment depth	$l_{f,1}$ [mm]	-	40	50	65	-	-
Diameter of anchor	d_{nom} [mm]	8	10	12	16	20	24
Installation safety factor	γ_{inst} [-]	1,00					

¹⁾ In absence of other national regulations

Hilti metal expansion anchor HST, HST-R, HST-HCR, HST3, HST3-R

Performances

Characteristic values of resistance under shear loading in cracked and non-cracked concrete

Annex C8

Table C5: Displacements under tension and shear loads for Hilti metal expansion anchor HST, HST-R and HST-HCR for static and quasi static loading

			M8	M10	M12	M16	M20 ¹⁾	M24 ¹⁾
Displacements under tension loading								
HST								
Tension load in cracked concrete	N	[kN]	2,0	4,3	5,7	9,5	14,3	19,0
Corresponding displacement	δ_{N0}	[mm]	1,3	0,2	0,1	0,5	1,9	2,2
	$\delta_{N\infty}$	[mm]	1,2	1,0	1,2	1,2	2,3	2,5
Tension load in non-cracked concrete	N	[kN]	3,6	7,6	9,5	16,7	23,8	28,6
Corresponding displacement	δ_{N0}	[mm]	0,2	0,1	0,1	0,4	0,6	0,5
	$\delta_{N\infty}$	[mm]	1,1	1,1	1,1	1,1	1,4	1,4
HST-R and HST-HCR								
Tension load in cracked concrete	N	[kN]	2,4	4,3	5,7	11,9	14,3	19,0
Corresponding displacement	δ_{N0}	[mm]	0,6	0,2	0,8	1,0	1,1	0,8
	$\delta_{N\infty}$	[mm]	1,5	1,2	1,4	1,2	1,2	1,7
Tension load in non-cracked concrete	N	[kN]	4,3	7,6	9,5	16,7	23,8	28,6
Corresponding displacement	δ_{N0}	[mm]	0,1	0,1	0,1	0,1	0,5	0,8
	$\delta_{N\infty}$	[mm]	1,5	1,2	1,4	1,2	1,2	1,7
Displacements under shear loading								
HST								
Shear load in cracked and non-cracked concrete	V	[kN]	8,0	13,4	20,0	31,4	48,0	45,0
Corresponding displacement	δ_{V0}	[mm]	2,5	2,5	3,7	4,0	2,7	2,0
	$\delta_{V\infty}$	[mm]	3,8	3,7	5,5	6,0	4,1	3,0
HST-R and HST-HCR								
Shear load in cracked and non-cracked concrete	V	[kN]	7,4	11,0	17,0	27,5	40,0	57,0
Corresponding displacement	δ_{V0}	[mm]	1,6	3,3	4,9	2,2	2,5	2,5
	$\delta_{V\infty}$	[mm]	2,4	4,9	7,4	3,3	3,7	3,7

¹⁾ Only HST and HST-R

Hilti metal expansion anchor HST, HST-R, HST-HCR, HST3, HST3-R

Performances
Displacements under tension and shear loading

Annex C9

Table C6: Displacements under tension and shear loads for Hilti metal expansion anchor HST3 and HST3-R for static and quasi static loading

			M8	M10	M12	M16	M20	M24
Displacements under tension loading								
HST3								
Effective embedment depth	$h_{ef,2}$	[mm]	47	60	70	85	101	125
Tension load in cracked concrete	N	[kN]	3,6	5,7	9,5	13,4	17,4	19,0
Corresponding displacement	δ_{N0}	[mm]	0,6	0,6	0,8	1,8	1,3	2,2
	$\delta_{N\infty}$	[mm]	1,1	1,3	1,6	1,7	1,8	2,5
Tension load in non-cracked concrete	N	[kN]	5,7	9,5	11,9	18,9	24,4	28,6
Corresponding displacement	δ_{N0}	[mm]	0,2	0,3	0,2	0,8	0,5	0,5
	$\delta_{N\infty}$	[mm]	0,4	0,5	0,4	1,5	0,9	1,4
HST3-R								
Effective embedment depth	$h_{ef,2}$	[mm]	47	60	70	85	101	125
Tension load in cracked concrete	N	[kN]	3,6	5,7	9,5	13,4	17,4	19,0
Corresponding displacement	δ_{N0}	[mm]	0,6	0,6	0,8	1,8	1,3	0,8
	$\delta_{N\infty}$	[mm]	1,1	1,3	1,6	1,7	1,8	1,7
Tension load in non-cracked concrete	N	[kN]	5,7	9,5	11,9	18,9	24,4	28,6
Corresponding displacement	δ_{N0}	[mm]	0,2	0,3	0,2	0,8	0,5	0,8
	$\delta_{N\infty}$	[mm]	0,4	0,5	0,4	1,5	0,9	1,7
HST3 and HST3-R								
Effective embedment depth	$h_{ef,1}$	[mm]	-	40	50	65	-	-
Tension load in cracked concrete	N	[kN]	-	4,3	6,1	9,0	-	-
Corresponding displacement	δ_{N0}	[mm]	-	0,6	0,4	0,6	-	-
	$\delta_{N\infty}$	[mm]	-	1,3	1,6	1,7	-	-
Tension load in non-cracked concrete	N	[kN]	-	6,1	8,5	12,6	-	-
Corresponding displacement	δ_{N0}	[mm]	-	0,2	0,7	0,8	-	-
	$\delta_{N\infty}$	[mm]	-	0,4	1,2	1,5	-	-

Hilti metal expansion anchor HST, HST-R, HST-HCR, HST3, HST3-R

Performances
Displacements under tension and shear loading

Annex C10

Table C6 continued

			M8	M10	M12	M16	M20	M24
Displacements under shear loading								
HST3								
Effective embedment depth	$h_{ef,2}$	[mm]	47	60	70	85	101	125
Shear load in cracked and non-cracked concrete	V	[kN]	7,9	13,5	20,2	31,6	47,9	45,0
Corresponding displacement	δ_{V0}	[mm]	2,8	2,5	3,8	4,3	2,7	2,0
	$\delta_{V\infty}$	[mm]	4,2	3,7	5,6	6,4	4,1	3,0
Shear load in cracked and non-cracked concrete using Filling Set	V	[kN]	9,5	14,7	22,3	34,8	57,4	-
Corresponding displacement	δ_{V0}	[mm]	2,9	2,3	2,0	2,3	5,9	-
	$\delta_{V\infty}$	[mm]	4,4	3,4	3,0	3,5	8,8	-
HST3-R								
Effective embedment depth	$h_{ef,2}$	[mm]	47	60	70	85	101	125
Shear load in cracked and non-cracked concrete	V	[kN]	8,9	14,5	21,0	36,3	55,6	57,0
Corresponding displacement	δ_{V0}	[mm]	7,1	2,3	3,3	5,7	3,2	2,5
	$\delta_{V\infty}$	[mm]	10,7	3,4	4,9	8,5	4,8	3,7
Shear load in cracked and non-cracked concrete using Filling Set	V	[kN]	11,1	16,2	25,3	40,1	58,7	-
Corresponding displacement	δ_{V0}	[mm]	1,9	2,0	2,3	3,4	4,9	-
	$\delta_{V\infty}$	[mm]	2,9	3,0	3,4	5,0	7,3	-

Hilti metal expansion anchor HST, HST-R, HST-HCR, HST3, HST3-R

Performances
Displacements under tension and shear loading

Annex C11

Table C6 continued

			M8	M10	M12	M16	M20	M24
Displacements under shear loading								
HST3								
Effective embedment depth	$h_{ef,1}$	[mm]	-	40	50	65	-	-
Shear load in cracked and non-cracked concrete	V	[kN]	-	12,5	19,4	31,1	-	-
Corresponding displacement	δ_{v0}	[mm]	-	4,2	3,1	4,4	-	-
	$\delta_{v\infty}$	[mm]	-	6,3	4,7	6,6	-	-
HST3-R								
Effective embedment depth	$h_{ef,1}$	[mm]	-	40	50	65	-	-
Shear load in cracked and non-cracked concrete	V	[kN]	-	14,6	17,8	27,8	-	-
Corresponding displacement	δ_{v0}	[mm]	-	3,7	3,9	3,5	-	-
	$\delta_{v\infty}$	[mm]	-	5,6	5,8	5,3	-	-

Hilti metal expansion anchor HST, HST-R, HST-HCR, HST3, HST3-R

Performances
Displacements under tension and shear loading

Annex C12

Table C7: Characteristic tension resistance for seismic loading for Hilti metal expansion anchor HST and HST-R, performance category C1

		M8	M10	M12	M16	M20	M24
Steel failure							
HST							
Characteristic resistance	$N_{Rk,s,seis}$ [kN]	-	32,0	45,0	76,0	-	-
Partial safety factor	$\gamma_{Ms,seis}^{1)}$ [-]	-	1,50		-	-	-
HST-R							
Characteristic resistance	$N_{Rk,s,seis}$ [kN]	-	28,0	40,0	69,0	-	-
Partial safety factor	$\gamma_{Ms,seis}^{1)}$ [-]	-	1,50	1,56	-	-	-
Pullout failure							
HST and HST-R							
Characteristic resistance	$N_{Rk,p,seis}$ [kN]	-	8,0	10,7	18,0	-	-
Installation safety factor	γ_{inst} [-]	-	1,00		-	-	-
Concrete cone failure ²⁾							
HST and HST-R							
Installation safety factor	γ_{inst} [-]	-	1,00		-	-	-
Splitting failure ²⁾							
HST and HST-R							
Installation safety factor	γ_{inst} [-]	-	1,00		-	-	-

¹⁾ In absence of other national regulations

²⁾ For concrete cone failure and splitting failure see EN 1992-4:2018

Hilti metal expansion anchor HST, HST-R, HST-HCR, HST3, HST3-R

Performances

Characteristic tension resistance for performance category C1

Annex C13

Table C8: Characteristic tension resistance for seismic loading for Hilti metal expansion anchor HST3 and HST3-R, performance category C1

		M8	M10	M12	M16	M20	M24
Steel failure							
HST3							
Effective embedment depth	$h_{ef,2}$ [mm]	47	60	70	85	101	-
Characteristic resistance	$N_{Rk,s,seis}$ [kN]	19,7	32,5	45,1	76,0	124,2	-
Partial safety factor	$\gamma_{Ms,seis}^{1)}$ [-]	1,40					-
HST3-R							
Effective embedment depth	$h_{ef,2}$ [mm]	47	60	70	85	101	-
Characteristic resistance	$N_{Rk,s,seis}$ [kN]	17,7	28,7	42,5	69,4	115,8	-
Partial safety factor	$\gamma_{Ms,seis}^{1)}$ [-]	1,40					-
Pullout failure							
HST3							
Effective embedment depth	$h_{ef,2}$ [mm]	47	60	70	85	101	-
Characteristic resistance	$N_{Rk,p,seis}$ [kN]	8,0	15,0	20,0	27,0	35,0	-
Installation safety factor	γ_{inst} [-]	1,00					-
HST3-R							
Effective embedment depth	$h_{ef,2}$ [mm]	47	60	70	85	101	-
Characteristic resistance	$N_{Rk,p,seis}$ [kN]	8,5	15,0	20,0	27,0	35,0	-
Installation safety factor	γ_{inst} [-]	1,00					-
Concrete cone failure ²⁾							
HST3 and HST3-R							
Effective embedment depth	$h_{ef,2}$ [mm]	47	60	70	85	101	-
Installation safety factor	γ_{inst} [-]	1,00					-
Splitting failure ²⁾							
HST3 and HST3-R							
Effective embedment depth	$h_{ef,2}$ [mm]	47	60	70	85	101	-
Installation safety factor	γ_{inst} [-]	1,00					-

¹⁾ In absence of other national regulations

²⁾ For concrete cone failure and splitting failure see EN 1992-4:2018

Hilti metal expansion anchor HST, HST-R, HST-HCR, HST3, HST3-R

Performances

Characteristic tension resistance for performance category C1

Annex C14

Table C9: Characteristic shear resistance for seismic loading for Hilti metal expansion anchor HST and HST-R, performance category C1

			M8	M10	M12	M16	M20	M24
Steel failure								
HST								
Characteristic resistance	$V_{Rk,s,seis}$	[kN]	-	16,0	27,0	41,3	-	-
Partial safety factor	$\gamma_{Ms,seis}^{1)}$	[-]	-	1,25			-	-
HST-R								
Characteristic resistance	$V_{Rk,s,seis}$	[kN]	-	13,6	23,1	37,5	-	-
Partial safety factor	$\gamma_{Ms,seis}^{1)}$	[-]	-	1,25		1,30	-	-
Concrete pryout failure ²⁾								
HST and HST-R								
Installation safety factor	γ_{inst}	[-]	-	1,00			-	-
Concrete edge failure ²⁾								
HST and HST-R								
Installation safety factor	γ_{inst}	[-]	-	1,00			-	-

¹⁾ In absence of other national regulations

²⁾ For concrete pryout failure and concrete edge failure see EN 1992-4:2018

Hilti metal expansion anchor HST, HST-R, HST-HCR, HST3, HST3-R

Performances

Characteristic shear resistance for performance category C1

Annex C15

Table C10: Characteristic shear resistance for seismic loading for Hilti metal expansion anchor HST3 and HST3-R, performance category C1

		M8	M10	M12	M16	M20	M24
Steel failure							
HST3							
Effective embedment depth	$h_{ef,2}$ [mm]	47	60	70	85	101	-
Characteristic resistance	$V_{Rk,s,seis}$ [kN]	12,5	21,4	32,2	48,7	77,6	-
Characteristic resistance using Filling Set	$V_{Rk,s,seis}$ [kN]	16,6	25,8	39,0	60,9	100,4	-
Partial safety factor	$\gamma_{Ms,seis}^{1)}$ [-]	1,25					-
HST3-R							
Effective embedment depth	$h_{ef,2}$ [mm]	47	60	70	85	101	-
Characteristic resistance	$V_{Rk,s,seis}$ [kN]	15,0	22,8	36,6	60,4	56,7	-
Characteristic resistance using Filling Set	$V_{Rk,s,seis}$ [kN]	19,5	28,4	44,3	70,2	102,7	-
Partial safety factor	$\gamma_{Ms,seis}^{1)}$ [-]	1,25					-
Concrete pryout failure ²⁾							
HST3 and HST3-R							
Effective embedment depth	$h_{ef,2}$ [mm]	47	60	70	85	101	-
Installation safety factor	γ_{inst} [-]	1,00					-
Concrete edge failure ²⁾							
HST3 and HST3-R							
Effective embedment depth	$h_{ef,2}$ [mm]	47	60	70	85	101	-
Installation safety factor	γ_{inst} [-]	1,00					-

¹⁾ In absence of other national regulations

²⁾ For concrete pryout failure and concrete edge failure see EN 1992-4:2018

Hilti metal expansion anchor HST, HST-R, HST-HCR, HST3, HST3-R

Performances
Characteristic shear resistance for performance category C1

Annex C16

Table C11: Characteristic tension resistance for seismic loading for Hilti metal expansion anchor HST and HST-R, performance category C2

		M8	M10	M12	M16	M20	M24
Steel failure							
HST							
Characteristic resistance	$N_{Rk,s,seis}$ [kN]	-	32,0	45,0	76,0	-	-
Partial safety factor	$\gamma_{Ms,seis}^{1)}$ [-]	-	1,50		-	-	-
HST-R							
Characteristic resistance	$N_{Rk,s,seis}$ [kN]	-	28,0	40,0	69,0	-	-
Partial safety factor	$\gamma_{Ms,seis}^{1)}$ [-]	-	1,50		1,56	-	-
Pullout failure							
HST and HST-R							
Characteristic resistance	$N_{Rk,p,seis}$ [kN]	-	3,3	10,0	12,8	-	-
Installation safety factor	γ_{inst} [-]	-	1,00		-	-	-
Concrete cone failure ²⁾							
HST and HST-R							
Installation safety factor	γ_{inst} [-]	-	1,00		-	-	-
Splitting failure ²⁾							
HST and HST-R							
Installation safety factor	γ_{inst} [-]	-	1,00		-	-	-

¹⁾ In absence of other national regulations

²⁾ For concrete cone failure and splitting failure see EN 1992-4:2018

Table C12: Displacements under tension loads for seismic loading for Hilti metal expansion anchor HST and HST-R, performance category C2

		M8	M10	M12	M16	M20	M24
HST and HST-R							
Displacement DLS	$\delta_{N,seis}$ [mm]	-	1,4	6,7	4,0	-	-
Displacement ULS	$\delta_{N,seis}$ [mm]	-	8,6	15,9	13,3	-	-

Hilti metal expansion anchor HST, HST-R, HST-HCR, HST3, HST3-R

Performances

Characteristic tension resistance and displacements under tension loads for performance category C2

Annex C17

Table C13: Characteristic tension resistance for seismic loading for Hilti metal expansion anchor HST3 and HST3-R, performance category C2

			M8	M10	M12	M16	M20	M24
Steel failure								
HST3								
Effective embedment depth	$h_{ef,2}$	[mm]	47	60	70	85	101	-
Effective embedment depth	$h_{ef,1}$	[mm]	-	-	50	-	-	-
Characteristic resistance	$N_{Rk,s,seis}$	[kN]	19,7	32,5	45,1	76,0	124,2	-
Partial safety factor	$\gamma_{Ms,seis}^{1)}$	[-]	1,40					-
HST3-R								
Effective embedment depth	$h_{ef,2}$	[mm]	47	60	70	85	101	-
Characteristic resistance	$N_{Rk,s,seis}$	[kN]	17,7	28,7	42,5	69,4	115,8	-
Partial safety factor	$\gamma_{Ms,seis}^{1)}$	[-]	1,40					-
Pullout failure								
HST3								
Effective embedment depth	$h_{ef,2}$	[mm]	47	60	70	85	101	-
Characteristic resistance	$N_{Rk,p,seis}$	[kN]	3,0	10,4	19,5	27,0	35,0	-
Installation safety factor	γ_{inst}	[-]	1,00					-
Effective embedment depth	$h_{ef,1}$	[mm]	-	-	50	-	-	-
Characteristic resistance	$N_{Rk,p,seis}$	[kN]	-	-	11,4	-	-	-
Installation safety factor	γ_{inst}	[-]	1,00					-
HST3-R								
Effective embedment depth	$h_{ef,2}$	[mm]	47	60	70	85	101	-
Characteristic resistance	$N_{Rk,p,seis}$	[kN]	3,4	10,4	19,5	27,0	35,0	-
Installation safety factor	γ_{inst}	[-]	1,00					-
Concrete cone failure ²⁾								
HST3 and HST3-R								
Effective embedment depth	$h_{ef,2}$	[mm]	47	60	70	85	101	-
Effective embedment depth	$h_{ef,1}$	[mm]	-	-	50	-	-	-
Installation safety factor	γ_{inst}	[-]	1,00					-

¹⁾ In absence of other national regulations

²⁾ For concrete cone failure and splitting failure see EN 1992-4:2018

Hilti metal expansion anchor HST, HST-R, HST-HCR, HST3, HST3-R

Performances

Characteristic tension resistance for performance category C2

Annex C18

Table C13 continued

			M8	M10	M12	M16	M20	M24
Splitting failure ²⁾								
HST3 and HST3-R								
Effective embedment depth	$h_{ef,2}$	[mm]	47	60	70	85	101	-
Effective embedment depth	$h_{ef,1}$	[mm]	-	-	50	-	-	-
Installation safety factor	γ_{inst}	[-]	1,00					-

²⁾ For concrete cone failure and splitting failure see EN 1992-4:2018

Table C14: Displacements under tension loads for seismic loading for Hilti metal expansion anchor HST3 and HST3-R, performance category C2

			M8	M10	M12	M16	M20	M24
HST3 and HST3-R								
Effective embedment depth	$h_{ef,2}$	[mm]	47	60	70	85	101	-
Displacement DLS	$\delta_{N,seis}$	[mm]	2,7	3,9	5,2	5,2	6,9	-
Displacement ULS	$\delta_{N,seis}$	[mm]	10,5	13,7	13,9	11,9	18,4	-
HST3								
Effective embedment depth	$h_{ef,1}$	[mm]	-	-	50	-	-	-
Displacement DLS	$\delta_{N,seis}$	[mm]	-	-	1,2	-	-	-
Displacement ULS	$\delta_{N,seis}$	[mm]	-	-	2,5	-	-	-

Hilti metal expansion anchor HST, HST-R, HST-HCR, HST3, HST3-R

Performances

Characteristic tension resistance and displacements under tension loads for performance category C2

Annex C19

Table C15: Characteristic shear resistance for seismic loading for Hilti metal expansion anchor HST and HST-R, performance category C2

		M8	M10	M12	M16	M20	M24
Steel failure							
HST							
Characteristic resistance	$V_{Rk,s,seis}$ [kN]	-	14,3	21,0	41,3	-	-
Partial safety factor	$\gamma_{Ms,seis}^{1)}$ [-]	-	1,25			-	-
HST-R							
Characteristic resistance	$V_{Rk,s,seis}$ [kN]	-	12,0	18,0	37,5	-	-
Partial safety factor	$\gamma_{Ms,seis}^{1)}$ [-]	-	1,25		1,30	-	-
Concrete pryout failure ²⁾							
HST and HST-R							
Installation safety factor	γ_{inst} [-]	-	1,00			-	-
Concrete edge failure ²⁾							
HST and HST-R							
Installation safety factor	γ_{inst} [-]	-	1,00			-	-

¹⁾ In absence of other national regulations

²⁾ For concrete pryout failure and concrete edge failure see EN 1992-4:2018

Table C16: Displacements under shear loads for seismic loading for Hilti metal expansion anchor HST and HST-R, performance category C2

		M8	M10	M12	M16	M20	M24
HST and HST-R							
Displacement DLS	$\delta_{V,seis}$ [mm]	-	4,2	5,3	5,7	-	-
Displacement ULS	$\delta_{V,seis}$ [mm]	-	7,5	7,9	8,9	-	-

Hilti metal expansion anchor HST, HST-R, HST-HCR, HST3, HST3-R

Performances

Characteristic shear resistance and displacements under shear loads for performance category C2

Annex C20

Table C17: Characteristic shear resistance for seismic loading for Hilti metal expansion anchor HST3 and HST3-R, performance category C2

		M8	M10	M12	M16	M20	M24
Steel failure							
HST3							
Effective embedment depth	$h_{ef,2}$ [mm]	47	60	70	85	101	-
Characteristic resistance	$V_{Rk,s,seis}$ [kN]	9,5	16,1	26,1	42,4	66,9	-
Characteristic resistance using Filling Set	$V_{Rk,s,seis}$ [kN]	9,9	19,0	28,6	48,5	84,3	-
Partial safety factor	$\gamma_{Ms,seis}^{1)}$ [-]	1,25					-
Effective embedment depth	$h_{ef,1}$ [mm]	-	-	50	-	-	-
Characteristic resistance	$V_{Rk,s,seis}$ [kN]	-	-	15,6	-	-	-
Partial safety factor	$\gamma_{Ms,seis}^{1)}$ [-]	1,25					-
HST3-R							
Effective embedment depth	$h_{ef,2}$ [mm]	47	60	70	85	101	-
Characteristic resistance	$V_{Rk,s,seis}$ [kN]	8,1	15,7	22,4	42,6	49,5	-
Characteristic resistance using Filling Set	$V_{Rk,s,seis}$ [kN]	9,9	17,2	27,6	42,5	67,4	-
Partial safety factor	$\gamma_{Ms,seis}^{1)}$ [-]	1,25					-
Concrete pryout failure ²⁾							
HST3 and HST3-R							
Effective embedment depth	$h_{ef,2}$ [mm]	47	60	70	85	101	-
Effective embedment depth	$h_{ef,1}$ [mm]	-	-	50	-	-	-
Installation safety factor	γ_{inst} [-]	1,00					-
Concrete edge failure ²⁾							
HST3 and HST3-R							
Effective embedment depth	$h_{ef,2}$ [mm]	47	60	70	85	101	-
Effective embedment depth	$h_{ef,1}$ [mm]	-	-	50	-	-	-
Installation safety factor	γ_{inst} [-]	1,00					-

¹⁾ In absence of other national regulations

²⁾ For concrete cone failure and splitting failure see EN 1992-4:2018

Hilti metal expansion anchor HST, HST-R, HST-HCR, HST3, HST3-R

Performances
Characteristic shear resistance for performance category C2

Annex C21

Table C18: Displacements under shear loads for seismic loading for Hilti metal expansion anchor HST3 and HST3-R, performance category C2

		M8	M10	M12	M16	M20	M24
HST3							
Effective embedment depth	$h_{ef,2}$ [mm]	47	60	70	85	101	-
Displacement DLS	$\delta_{V,seis}$ [mm]	3,4	4,0	4,6	4,8	5,2	-
Displacement DLS using Filling Set	$\delta_{V,seis}$ [mm]	1,4	1,6	2,5	1,7	1,9	-
Displacement ULS	$\delta_{V,seis}$ [mm]	4,9	6,2	8,1	8,2	10,0	-
Displacement ULS using Filling Set	$\delta_{V,seis}$ [mm]	4,3	4,4	7,2	3,9	5,3	-
Effective embedment depth	$h_{ef,1}$ [mm]	-	-	50	-	-	-
Displacement DLS	$\delta_{V,seis}$ [mm]	-	-	5,2	-	-	-
Displacement ULS	$\delta_{V,seis}$ [mm]	-	-	8,4	-	-	-
HST3-R							
Effective embedment depth	$h_{ef,2}$ [mm]	47	60	70	85	101	-
Displacement DLS	$\delta_{V,seis}$ [mm]	3,5	5,0	6,0	5,8	3,9	-
Displacement DLS using Filling Set	$\delta_{V,seis}$ [mm]	1,6	1,6	2,0	1,9	2,2	-
Displacement ULS	$\delta_{V,seis}$ [mm]	7,5	9,1	10,1	12,3	7,0	-
Displacement ULS using Filling Set	$\delta_{V,seis}$ [mm]	5,0	7,6	6,8	4,7	5,8	-

Hilti metal expansion anchor HST, HST-R, HST-HCR, HST3, HST3-R

Performances
Displacements under shear loads for performance category C2

Annex C22

Table C19: Characteristic tension resistance under fire exposure for Hilti metal expansion anchor HST, HST-R and HST-HCR in cracked and non-cracked concrete

				M8	M10	M12	M16	M20 ¹⁾	M24 ¹⁾
Steel failure									
HST									
Characteristic resistance	R30	$N_{Rk,s,fi}$	[kN]	0,9	2,5	5,0	9,0	15,0	20,0
	R60	$N_{Rk,s,fi}$	[kN]	0,7	1,5	3,5	6,0	10,0	15,0
	R90	$N_{Rk,s,fi}$	[kN]	0,6	1,0	2,0	3,5	6,0	8,0
	R120	$N_{Rk,s,fi}$	[kN]	0,5	0,7	1,0	2,0	3,5	5,0
HST-R and HST HCR									
Characteristic resistance	R30	$N_{Rk,s,fi}$	[kN]	4,9	11,8	17,2	32,0	49,9	71,9
	R60	$N_{Rk,s,fi}$	[kN]	3,6	8,4	12,2	22,8	35,5	51,2
	R90	$N_{Rk,s,fi}$	[kN]	2,4	5,0	7,3	13,5	21,1	30,4
	R120	$N_{Rk,s,fi}$	[kN]	1,7	3,3	4,8	8,9	13,9	20,0
Pullout failure									
HST									
Characteristic resistance in concrete $\geq C20/25$	R30	$N_{Rk,p,fi}$	[kN]	1,3	2,3	3,0	5,0	7,5	10,0
	R60	$N_{Rk,p,fi}$	[kN]						
	R90	$N_{Rk,p,fi}$	[kN]						
	R120	$N_{Rk,p,fi}$	[kN]	1,0	1,8	2,4	4,0	6,0	8,0
HST-R and HST-HCR									
Characteristic resistance in concrete $\geq C20/25$	R30	$N_{Rk,p,fi}$	[kN]	1,3	2,3	3,0	6,3	7,5	10,0
	R60	$N_{Rk,p,fi}$	[kN]						
	R90	$N_{Rk,p,fi}$	[kN]						
	R120	$N_{Rk,p,fi}$	[kN]	1,0	1,8	2,4	5,0	6,0	8,0

¹⁾ Only HST and HST-R

In absence of other national regulations the partial safety factor for resistance under fire exposure $\gamma_{M,fi} = 1,0$ is recommended.

Hilti metal expansion anchor HST, HST-R, HST-HCR, HST3, HST3-R

Performances

Characteristic values of resistance under tension loading under fire exposure in cracked and non-cracked concrete

Annex C23

Table C19 continued

			M8	M10	M12	M16	M20 ¹⁾	M24 ¹⁾
Concrete cone failure								
HST, HST-R and HST-HCR								
Characteristic resistance in concrete \geq C20/25	R30	$N^{0}_{Rk,c,fi}$ [kN]	2,7	5,0	7,4	11,0	18,5	31,4
	R60	$N^{0}_{Rk,c,fi}$ [kN]						
	R90	$N^{0}_{Rk,c,fi}$ [kN]						
	R120	$N^{0}_{Rk,c,fi}$ [kN]						
Spacing	$s_{cr,N}$	[mm]	4 h_{ef}					
	s_{min}	[mm]	40	55	60	70	100	125
Edge distance	$c_{cr,N}$	[mm]	2 h_{ef}					
	c_{min}	[mm]	Fire attack from one side: 2 h_{ef} Fire attack from more than one side: \geq 300					

¹⁾ Only HST and HST-R

In absence of other national regulations the partial safety factor for resistance under fire exposure $\gamma_{M,fi} = 1,0$ is recommended.

Hilti metal expansion anchor HST, HST-R, HST-HCR, HST3, HST3-R

Performances

Characteristic values of resistance under tension loading under fire exposure in cracked and non-cracked concrete

Annex C24

Table C20: Characteristic tension resistance under fire exposure for Hilti metal expansion anchor HST3 and HST3-R in cracked and non-cracked concrete

			M8	M10	M12	M16	M20	M24
Steel failure								
HST3								
Effective embedment depth	$h_{ef,2}$	[mm]	47	60	70	85	101	125
Characteristic resistance	R30	$N_{Rk,s,fi}$ [kN]	0,9	2,4	5,2	9,7	15,2	21,9
	R60	$N_{Rk,s,fi}$ [kN]	0,8	1,8	3,7	6,8	10,6	15,3
	R90	$N_{Rk,s,fi}$ [kN]	0,7	1,2	2,1	3,9	6,0	8,7
	R120	$N_{Rk,s,fi}$ [kN]	0,6	0,9	1,3	2,4	3,8	5,4
HST3-R								
Effective embedment depth	$h_{ef,2}$	[mm]	47	60	70	85	101	125
Characteristic resistance	R30	$N_{Rk,s,fi}$ [kN]	4,9	11,8	17,1	31,9	49,8	71,8
	R60	$N_{Rk,s,fi}$ [kN]	3,6	8,4	12,2	22,8	35,5	51,2
	R90	$N_{Rk,s,fi}$ [kN]	2,4	5,0	7,3	13,6	21,2	30,6
	R120	$N_{Rk,s,fi}$ [kN]	1,7	3,3	4,8	9,0	14,1	20,3
HST3								
Effective embedment depth	$h_{ef,1}$	[mm]	-	40	50	65	-	-
Characteristic resistance	R30	$N_{Rk,s,fi}$ [kN]	-	1,5	2,3	4,4	-	-
	R60	$N_{Rk,s,fi}$ [kN]	-	1,2	1,7	3,2	-	-
	R90	$N_{Rk,s,fi}$ [kN]	-	0,9	1,1	2,1	-	-
	R120	$N_{Rk,s,fi}$ [kN]	-	0,8	0,8	1,5	-	-
HST3-R								
Effective embedment depth	$h_{ef,1}$	[mm]	-	40	50	65	-	-
Characteristic resistance	R30	$N_{Rk,s,fi}$ [kN]	-	5,2	9,1	16,9	-	-
	R60	$N_{Rk,s,fi}$ [kN]	-	3,7	6,8	12,6	-	-
	R90	$N_{Rk,s,fi}$ [kN]	-	2,5	4,5	8,4	-	-
	R120	$N_{Rk,s,fi}$ [kN]	-	2,0	3,3	6,2	-	-

In absence of other national regulations the partial safety factor for resistance under fire exposure $\gamma_{M,fi} = 1,0$ is recommended.

Hilti metal expansion anchor HST, HST-R, HST-HCR, HST3, HST3-R

Performances

Characteristic values of resistance under tension loading under fire exposure in cracked and non-cracked concrete

Annex C25

Table C20 continued

			M8	M10	M12	M16	M20	M24
Pullout failure								
HST3 and HST3-R								
Effective embedment depth	$h_{ef,2}$	[mm]	47	60	70	85	101	125
Characteristic resistance in concrete $\geq C20/25$	R30	$N_{Rk,p,fi}$ [kN]	1,9	3,0	5,0	7,1	9,1	12,6
	R60	$N_{Rk,p,fi}$ [kN]						
	R90	$N_{Rk,p,fi}$ [kN]						
	R120	$N_{Rk,p,fi}$ [kN]						
HST3 and HST3-R								
Effective embedment depth	$h_{ef,1}$	[mm]	-	40	50	65	-	-
Characteristic resistance in concrete $\geq C20/25$	R30	$N_{Rk,p,fi}$ [kN]	-	2,3	3,2	4,7	-	-
	R60	$N_{Rk,p,fi}$ [kN]						
	R90	$N_{Rk,p,fi}$ [kN]						
	R120	$N_{Rk,p,fi}$ [kN]						

In absence of other national regulations the partial safety factor for resistance under fire exposure $\gamma_{M,fi} = 1,0$ is recommended.

Hilti metal expansion anchor HST, HST-R, HST-HCR, HST3, HST3-R

Performances

Characteristic values of resistance under tension loading under fire exposure in cracked and non-cracked concrete

Annex C26

Table C20 continued

			M8	M10	M12	M16	M20	M24
Concrete cone failure								
HST3 and HST3-R								
Effective embedment depth	$h_{ef,2}$	[mm]	47	60	70	85	101	125
Characteristic resistance in concrete \geq C20/25	R30	$N^0_{RK,c,fi}$ [kN]	2,7	5,0	7,4	12,0	18,5	31,4
	R60	$N^0_{RK,c,fi}$ [kN]						
	R90	$N^0_{RK,c,fi}$ [kN]						
	R120	$N^0_{RK,c,fi}$ [kN]						
Spacing	$s_{cr,N}$	[mm]	4 h_{ef}					
	s_{min}	[mm]	35	40	50	65	90	125
Edge distance	$c_{cr,N}$	[mm]	2 h_{ef}					
	c_{min}	[mm]	Fire attack from one side: 2 h_{ef} Fire attack from more than one side: \geq 300					
HST3 and HST3-R								
Effective embedment depth	$h_{ef,1}$	[mm]	-	40	50	65	-	-
Characteristic resistance in concrete \geq C20/25	R30	$N^0_{RK,c,fi}$ [kN]	-	1,8	3,2	6,1	-	-
	R60	$N^0_{RK,c,fi}$ [kN]						
	R90	$N^0_{RK,c,fi}$ [kN]						
	R120	$N^0_{RK,c,fi}$ [kN]						
Spacing	$s_{cr,N}$	[mm]	-	4 h_{ef}			-	-
	s_{min}	[mm]	-	40	50	65	-	-
Edge distance	$c_{cr,N}$	[mm]	-	2 h_{ef}			-	-
	c_{min}	[mm]	Fire attack from one side: 2 h_{ef} Fire attack from more than one side: \geq 300					

In absence of other national regulations the partial safety factor for resistance under fire exposure $\gamma_{M,fi} = 1,0$ is recommended.

Hilti metal expansion anchor HST, HST-R, HST-HCR, HST3, HST3-R

Performances

Characteristic values of resistance under tension loading under fire exposure in cracked and non-cracked concrete

Annex C27

Table C21: Characteristic shear resistance under fire exposure for Hilti metal expansion anchor HST, HST-R and HST-HCR in cracked and non-cracked concrete

				M8	M10	M12	M16	M20 ¹⁾	M24 ¹⁾
Steel failure without lever arm									
HST									
Characteristic resistance	R30	$V_{Rk,s,fi}$	[kN]	0,9	2,5	5,0	9,0	15,0	20,0
	R60	$V_{Rk,s,fi}$	[kN]	0,7	1,5	3,5	6,0	10,0	15,0
	R90	$V_{Rk,s,fi}$	[kN]	0,6	1,0	2,0	3,5	6,0	8,0
	R120	$V_{Rk,s,fi}$	[kN]	0,5	0,7	1,0	2,0	3,5	5,0
HST-R and HST HCR									
Characteristic resistance	R30	$V_{Rk,s,fi}$	[kN]	4,9	11,8	17,2	32,0	49,9	71,9
	R60	$V_{Rk,s,fi}$	[kN]	3,6	8,4	12,2	22,8	35,5	51,2
	R90	$V_{Rk,s,fi}$	[kN]	2,4	5,0	7,3	13,5	21,1	30,4
	R120	$V_{Rk,s,fi}$	[kN]	1,7	3,3	4,8	8,9	13,9	20,0
Steel failure with lever arm									
HST									
Characteristic resistance	R30	$M^0_{Rk,s,fi}$	[Nm]	1,0	3,3	8,1	20,6	40,2	69,5
	R60	$M^0_{Rk,s,fi}$	[Nm]	0,8	2,4	5,7	14,4	28,1	48,6
	R90	$M^0_{Rk,s,fi}$	[Nm]	0,7	1,6	3,2	8,2	16,0	27,7
	R120	$M^0_{Rk,s,fi}$	[Nm]	0,6	1,2	2,0	5,1	9,9	17,2
HST-R and HST HCR									
Characteristic resistance	R30	$M^0_{Rk,s,fi}$	[Nm]	5,0	15,2	26,6	67,7	132,3	228,6
	R60	$M^0_{Rk,s,fi}$	[Nm]	3,7	10,8	19,0	48,2	94,1	162,6
	R90	$M^0_{Rk,s,fi}$	[Nm]	2,4	6,4	11,3	28,6	55,9	96,6
	R120	$M^0_{Rk,s,fi}$	[Nm]	1,8	4,2	7,4	18,9	36,8	63,7

¹⁾ Only HST and HST-R

In absence of other national regulations the partial safety factor for resistance under fire exposure $\gamma_{M,fi} = 1,0$ is recommended.

Hilti metal expansion anchor HST, HST-R, HST-HCR, HST3, HST3-R

Performances

Characteristic values of resistance under shear loading under fire exposure in cracked and non-cracked concrete

Annex C28

Table C21 continued

			M8	M10	M12	M16	M20 ¹⁾	M24 ¹⁾
Concrete pryout failure								
HST, HST-R and HST-HCR								
Pryout factor	k_8	[-]	2,00	2,00	2,20	2,50	2,50	2,50
Characteristic resistance in concrete \geq C20/25	R30	$V_{Rk,cp,fi}^0$ [kN]	5,4	10,0	16,0	27,2	49,4	84,5
	R60	$V_{Rk,cp,fi}^0$ [kN]						
	R90	$V_{Rk,cp,fi}^0$ [kN]						
	R120	$V_{Rk,cp,fi}^0$ [kN]						
Concrete edge failure								
HST, HST-R and HST-HCR								
The initial value $V_{Rk,c,fi}^0$ of the characteristic resistance in concrete C20/25 to C50/60 under fire exposure may be determined by: $V_{Rk,c,fi}^0 = 0,25 \times V_{Rk,c}^0$ (\leq R90) $V_{Rk,c,fi}^0 = 0,20 \times V_{Rk,c}^0$ (R120) with $V_{Rk,c}^0$ initial value of the characteristic resistance in cracked concrete C20/25 under normal temperature.								

¹⁾ Only HST and HST-R

In absence of other national regulations the partial safety factor for resistance under fire exposure $\gamma_{M,fi} = 1,0$ is recommended.

Hilti metal expansion anchor HST, HST-R, HST-HCR, HST3, HST3-R

Performances

Characteristic values of resistance under shear loading under fire exposure in cracked and non-cracked concrete

Annex C29

Table C22: Characteristic shear resistance under fire exposure for Hilti metal expansion anchor HST3 and HST3-R in cracked and non-cracked concrete

			M8	M10	M12	M16	M20	M24
Steel failure without lever arm								
HST3								
Effective embedment depth	$h_{ef,2}$	[mm]	47	60	70	85	101	125
Characteristic resistance	R30	$V_{Rk,s,fi}$ [kN]	0,9	2,4	5,2	9,7	15,2	21,9
	R60	$V_{Rk,s,fi}$ [kN]	0,8	1,8	3,7	6,8	10,6	15,3
	R90	$V_{Rk,s,fi}$ [kN]	0,7	1,2	2,1	3,9	6,0	8,7
	R120	$V_{Rk,s,fi}$ [kN]	0,6	0,9	1,3	2,4	3,8	5,4
HST3-R								
Effective embedment depth	$h_{ef,2}$	[mm]	47	60	70	85	101	125
Characteristic resistance	R30	$V_{Rk,s,fi}$ [kN]	4,9	11,8	17,1	31,9	49,8	71,8
	R60	$V_{Rk,s,fi}$ [kN]	3,6	8,4	12,2	22,8	35,5	51,2
	R90	$V_{Rk,s,fi}$ [kN]	2,4	5,0	7,3	13,6	21,2	30,6
	R120	$V_{Rk,s,fi}$ [kN]	1,7	3,3	4,8	9,0	14,1	20,3
HST3								
Effective embedment depth	$h_{ef,1}$	[mm]	-	40	50	65	-	-
Characteristic resistance	R30	$V_{Rk,s,fi}$ [kN]		1,5	2,3	4,4		
	R60	$V_{Rk,s,fi}$ [kN]		1,2	1,7	3,2		
	R90	$V_{Rk,s,fi}$ [kN]		0,9	1,1	2,1		
	R120	$V_{Rk,s,fi}$ [kN]		0,8	0,8	1,5		
HST3-R								
Effective embedment depth	$h_{ef,1}$	[mm]	-	40	50	65	-	-
Characteristic resistance	R30	$V_{Rk,s,fi}$ [kN]		5,2	9,1	16,9		
	R60	$V_{Rk,s,fi}$ [kN]		3,7	6,8	12,6		
	R90	$V_{Rk,s,fi}$ [kN]		2,5	4,5	8,4		
	R120	$V_{Rk,s,fi}$ [kN]		2,0	3,3	6,2		

In absence of other national regulations the partial safety factor for resistance under fire exposure $\gamma_{M,fi} = 1,0$ is recommended.

Hilti metal expansion anchor HST, HST-R, HST-HCR, HST3, HST3-R

Performances

Characteristic values of resistance under shear loading under fire exposure in cracked and non-cracked concrete

Annex C30

Table C22 continued

			M8	M10	M12	M16	M20	M24
Steel failure with lever arm								
HST3								
Effective embedment depth	$h_{ef,2}$	[mm]	47	60	70	85	101	125
Characteristic resistance	R30	$M^0_{Rk,s,fi}$ [Nm]	0,9	3,1	8,1	20,6	40,2	69,5
	R60	$M^0_{Rk,s,fi}$ [Nm]	0,8	2,4	5,7	14,4	28,1	48,6
	R90	$M^0_{Rk,s,fi}$ [Nm]	0,7	1,6	3,2	8,2	16,0	27,7
	R120	$M^0_{Rk,s,fi}$ [Nm]	0,6	1,2	2,0	5,1	10,0	17,2
HST3-R								
Effective embedment depth	$h_{ef,2}$	[mm]	47	60	70	85	101	125
Characteristic resistance	R30	$M^0_{Rk,s,fi}$ [Nm]	5,0	15,2	26,6	67,6	132,0	228,2
	R60	$M^0_{Rk,s,fi}$ [Nm]	3,7	10,8	19,0	48,2	94,1	162,7
	R90	$M^0_{Rk,s,fi}$ [Nm]	2,4	6,5	11,3	28,8	56,3	97,2
	R120	$M^0_{Rk,s,fi}$ [Nm]	1,8	4,3	7,5	19,1	37,3	64,5
HST3								
Effective embedment depth	$h_{ef,1}$	[mm]	-	40	50	65	-	-
Characteristic resistance	R30	$M^0_{Rk,s,fi}$ [Nm]	-	2,0	3,6	9,3	-	-
	R60	$M^0_{Rk,s,fi}$ [Nm]	-	1,6	2,7	6,9	-	-
	R90	$M^0_{Rk,s,fi}$ [Nm]	-	1,2	1,8	4,5	-	-
	R120	$M^0_{Rk,s,fi}$ [Nm]	-	1,0	1,3	3,3	-	-
HST3-R								
Effective embedment depth	$h_{ef,1}$	[mm]	-	40	50	65	-	-
Characteristic resistance	R30	$M^0_{Rk,s,fi}$ [Nm]	-	6,7	14,1	35,9	-	-
	R60	$M^0_{Rk,s,fi}$ [Nm]	-	4,8	10,5	26,8	-	-
	R90	$M^0_{Rk,s,fi}$ [Nm]	-	3,2	7,0	17,7	-	-
	R120	$M^0_{Rk,s,fi}$ [Nm]	-	2,6	5,2	13,2	-	-

In absence of other national regulations the partial safety factor for resistance under fire exposure $\gamma_{M,fi} = 1,0$ is recommended.

Hilti metal expansion anchor HST, HST-R, HST-HCR, HST3, HST3-R

Performances

Characteristic values of resistance under shear loading under fire exposure in cracked and non-cracked concrete

Annex C31

Table C22 continued

			M8	M10	M12	M16	M20	M24
Concrete pryout failure								
HST3 and HST3-R								
Effective embedment depth	$h_{ef,2}$	[mm]	47	60	70	85	101	125
Pryout factor	k_8	[-]	2,62	2,67	2,78	3,41	3,20	2,50
Characteristic resistance in concrete \geq C20/25	R30	$V^0_{Rk,cp,fi}$ [kN]	7,0	13,0	20,7	40,8	37,0	62,8
	R60	$V^0_{Rk,cp,fi}$ [kN]						
	R90	$V^0_{Rk,cp,fi}$ [kN]						
	R120	$V^0_{Rk,cp,fi}$ [kN]						
HST3 and HST3-R								
Effective embedment depth	$h_{ef,1}$	[mm]	-	40	50	65	-	-
Pryout factor	k_8	[-]	-	2,67	2,78	3,41	-	-
Characteristic resistance in concrete \geq C20/25	R30	$V^0_{Rk,cp,fi}$ [kN]	-	4,7	8,9	20,8	-	-
	R60	$V^0_{Rk,cp,fi}$ [kN]						
	R90	$V^0_{Rk,cp,fi}$ [kN]						
	R120	$V^0_{Rk,cp,fi}$ [kN]						
Concrete edge failure								
HST3 and HST3-R								
The initial value $V^0_{Rk,c,fi}$ of the characteristic resistance in concrete C20/25 to C50/60 under fire exposure may be determined by: $V^0_{Rk,c,fi} = 0,25 \times V^0_{Rk,c}$ (\leq R90) $V^0_{Rk,c,fi} = 0,20 \times V^0_{Rk,c}$ (R120) with $V^0_{Rk,c}$ initial value of the characteristic resistance in cracked concrete C20/25 under normal temperature.								

In absence of other national regulations the partial safety factor for resistance under fire exposure $\gamma_{M,fi} = 1,0$ is recommended.

Hilti metal expansion anchor HST, HST-R, HST-HCR, HST3, HST3-R

Performances

Characteristic values of resistance under shear loading under fire exposure in cracked and non-cracked concrete

Annex C32