

Approval body for construction products
and types of construction

Bautechnisches Prüfamt

An institution established by the Federal and
Laender Governments



European Technical Assessment

ETA-07/0337
of 6 November 2020

English translation prepared by DIBt - Original version in German language

General Part

Technical Assessment Body issuing the
European Technical Assessment:

Deutsches Institut für Bautechnik

Trade name of the construction product

Multifunction frame plug MFR

Product family
to which the construction product belongs

Plastic anchors for redundant non-structural systems in
concrete and masonry

Manufacturer

CELO Befestigungssysteme GmbH
Industriestraße 6
86551 Aichach
DEUTSCHLAND

Manufacturing plant

CELO Werk I
Industriestrasse 6
D-86551 Aichach
Germany

This European Technical Assessment
contains

27 pages including 3 annexes which form an integral part
of this assessment

This European Technical Assessment is
issued in accordance with Regulation (EU)
No 305/2011, on the basis of

ETAG 020 Edition 2012, used
as EAD according to Article 66 Paragraph 3 of Regulation
(EU) No 305/2011

This version replaces

ETA-07/0337 issued on 4 September 2019

The European Technical Assessment is issued by the Technical Assessment Body in its official language. Translations of this European Technical Assessment in other languages shall fully correspond to the original issued document and shall be identified as such.

Communication of this European Technical Assessment, including transmission by electronic means, shall be in full. However, partial reproduction may only be made with the written consent of the issuing Technical Assessment Body. Any partial reproduction shall be identified as such.

This European Technical Assessment may be withdrawn by the issuing Technical Assessment Body, in particular pursuant to information by the Commission in accordance with Article 25(3) of Regulation (EU) No 305/2011.

Specific Part

1 Technical description of the product

The Multifunction frame plug in the range of MFR 8, MFR 10, MFR 10-60 and MFR 14 is a plastic anchor consisting of a plastic sleeve made of polyamide and an accompanying specific screw of galvanised steel or stainless steel.

The plastic sleeve is expanded by screwing in the specific screw which presses the sleeve against the wall of the drilled hole.

The product description is given in Annex A.

2 Specification of the intended use in accordance with the applicable European Assessment Document

The performances given in Section 3 are only valid if the anchor is used in compliance with the specifications and conditions given in Annex B.

The verifications and assessment methods on which this European Technical Assessment is based lead to the assumption of a working life of the anchors of at least 50 years. The indications given on the working life cannot be interpreted as a guarantee given by the producer, but are to be regarded only as a means for choosing the right products in relation to the expected economically reasonable working life of the works.

3 Performance of the product and references to the methods used for its assessment

3.1 Safety in case of fire (BWR 2)

Essential characteristic	Performance
Reaction to fire	Class A 1
Resistance to fire	See Annex C 3

3.2 Mechanical resistance and stability (BWR 4)

Essential characteristic	Performance
Resistance to steel failure under tension loading	See Annex C 1
Resistance to steel or polymer failure under shear loading	See Annex C 1
Resistance to pull-out or concrete failure or polymer failure under tension loading (use category a)	See Annex C 2
Resistance in any load direction without lever arm (use category b, c and d)	See Annexes C 4 – C 6 and C 9
Edge distance and spacing (use category a)	See Annex B 3
Edge distance and spacing (use category b, c and d)	See Annex B 4 – B 5
Displacements under short-term and long-term loading	See Annex C 7 - C8

English translation prepared by DIBt

4 Assessment and verification of constancy of performance (AVCP) system applied, with reference to its legal base

In accordance with guideline for European technical approval ETAG 020, March 2012 used as European Assessment Document (EAD) according to Article 66 Paragraph 3 of Regulation (EU) No 305/2011 the applicable European legal act is: 97/463/EC.

The system to be applied is: 2+

5 Technical details necessary for the implementation of the AVCP system, as provided for in the applicable European Assessment Document

Technical details necessary for the implementation of the AVCP system are laid down in the control plan deposited at Deutsches Institut für Bautechnik.

Issued in Berlin on 6 November 2020 by Deutsches Institut für Bautechnik

Dipl.-Ing. Beatrix Wittstock
Head of Section

beglaubigt:
Aksünger

Intended use in hollow brick

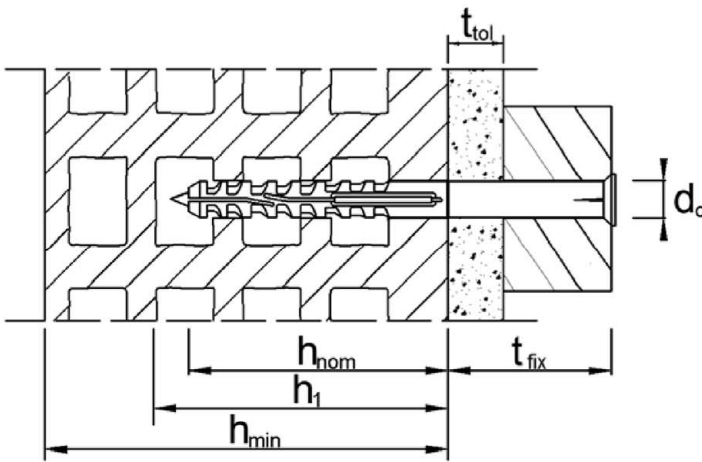

Intended use in concrete or solid base material

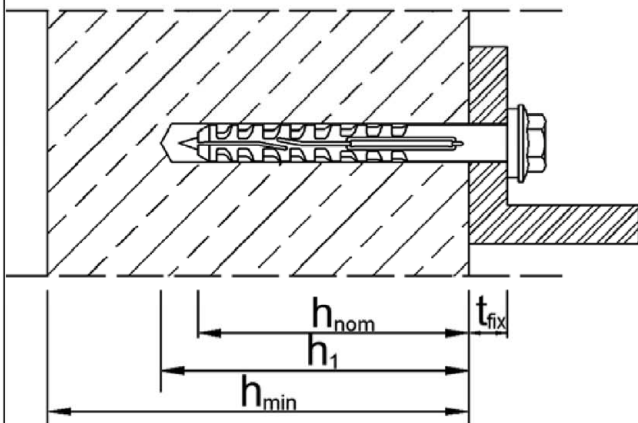

Intended use in precast prestressed hollow core slabs

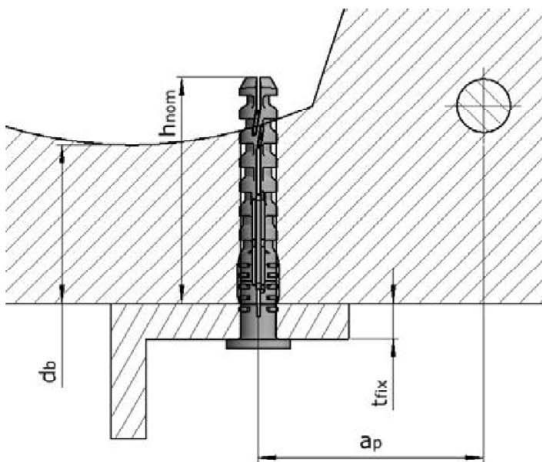

- h_{nom} = overall plastic anchor embedment depth in the base material
- h_1 = depth of drilled hole to deepest point
- h_{min} = Minimum thickness of member
- t_{fix} = thickness of fixture
- t_{tol} = thickness of layer or non-load bearing coating
- d_b = mirror thickness
- a_p = distance between plug and reinforcement

CELO Multifunction frame plug MFR

Product description
Installed condition

Annex A1

Anchor sleeve MFR 8

Sleeve with flat head (FB) or countersunk head (SB)

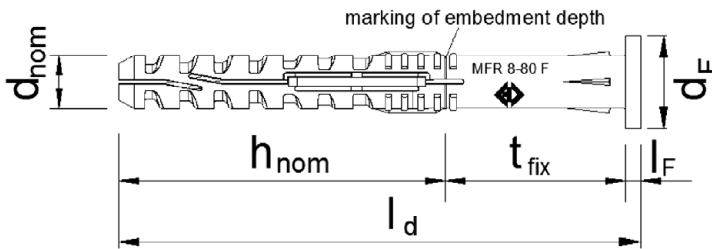

MFR 8 FB

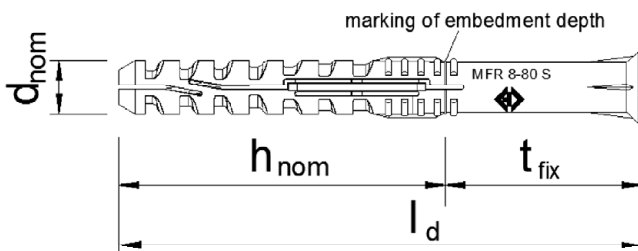

MFR 8 SB

Marking:	Brand	Type	diameter (d_{nom}) - length (l_d)	head form (optional)
Example:	CELO (or Logo)	MFR	8 - 80	F or S (F = FB) (S = SB)

Special screw (for MFR 8)

Screw head with different tool fittings

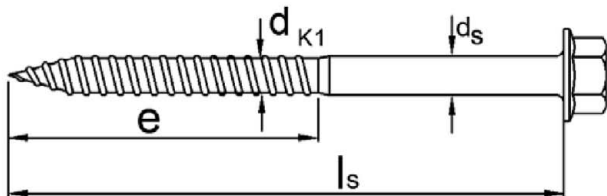

Type SSKS (or SSKS A4)
galvanised steel or
stainless steel (A4)



Type SSK (or SSK A4)
galvanised steel or stainless
steel (A4)



Type TX (or TX A4)
galvanised steel or
stainless steel (A4)

Marking:	Brand	Code No screw length	manufacturer code
Example:	X	12	1

CELO Multifunction frame plug MFR

Product description
MFR 8 – Anchor types, screw specification, marking

Annex A2

English translation prepared by DIBt

Anchor sleeve MFR 10

Sleeve with flat head (FB) or countersunk head (SB)

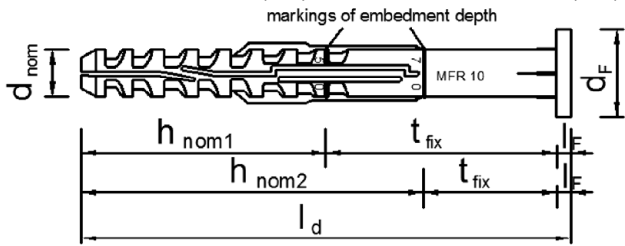

MFR 10 FB

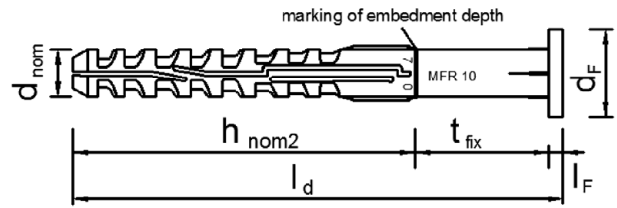

MFR 10 FB (alternative)

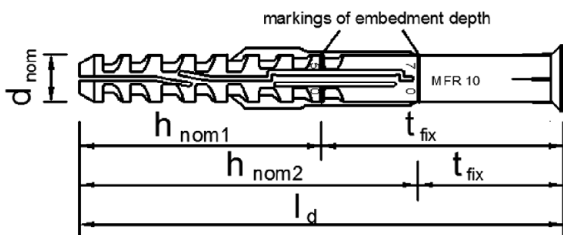

MFR 10 SB

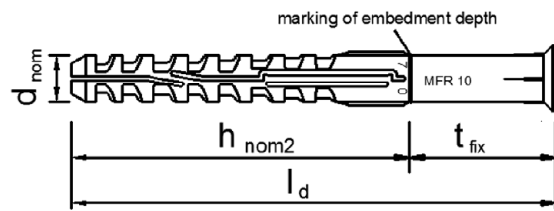

MFR 10 SB (alternative)

Marking:	Brand	Type	diameter (d_{nom}) - length (l_d)	head form (optional)
Example:	CELO (or Logo)	MFR	10 100	F or S (F = FB) (S = SB)

Special screw (for MFR 10)

Screw head with different tool fittings

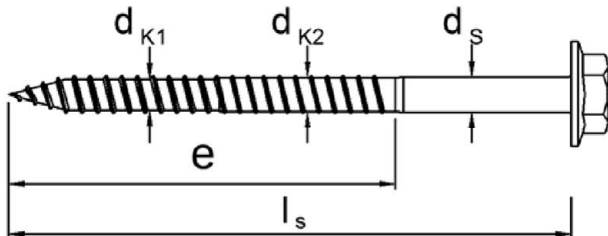

Type SSKS (or SSKS A4)
galvanised steel or
stainless steel (A4)



Type SSK (or SSK A4)
galvanised steel or
stainless steel (A4)

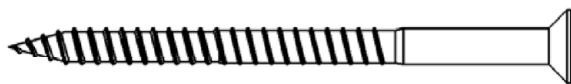

Type TX (or TX A4)
galvanised steel or
stainless steel (A4)

Marking:	Brand	Code No screw length	manufacturer code
Example:	X	12	1

CELO Multifunction frame plug MFR

Product description
MFR 10 – Anchor types, screw specification, marking

Annex A3

Anchor sleeve MFR 10-60

Sleeve with flat head (FB) or countersunk head (SB)

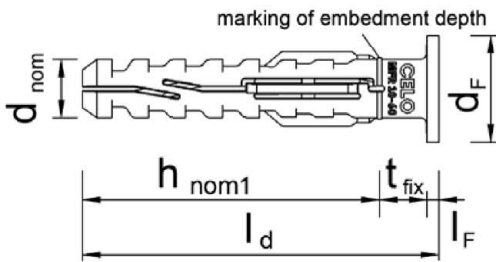

MFR 10-60 FB

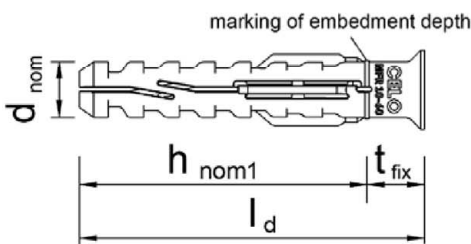

MFR 10-60 SB

Marking:	Brand	Type	diameter (d_{nom}) - length (l_d)		head form (optional)
Example:	CELO (or Logo)	MFR	10	60	F or S

Special screw (for MFR 10-60)

Screw head with different tool fittings

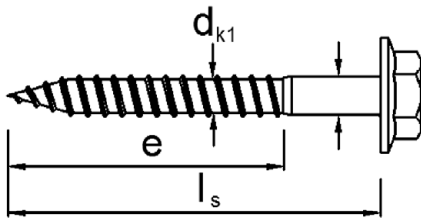

Type SSKS (or SSKS A4)
galvanised steel or
stainless steel (A4)

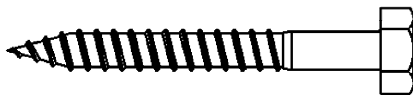

Type SSK (or SSK A4)
galvanised steel or
stainless steel (A4)



Type TX (or TX A4)
galvanised steel or
stainless steel (A4)

Marking:	Brand	Code No	screw length	manufacturer code
Example:	X	6	1	

CELO Multifunction frame plug MFR

Product description
MFR 10-60 – Anchor types, screw specification, marking

Annex A4

Anchor sleeve MFR 14

Sleeve with flat head (FB) or countersunk head (SB)

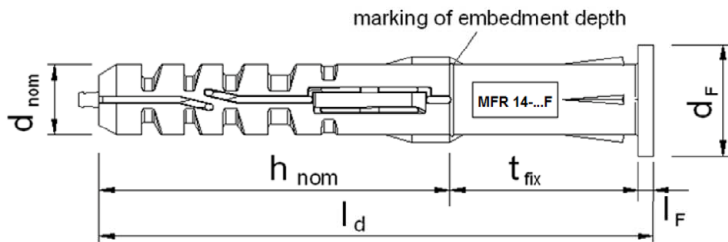

MFR 14 FB

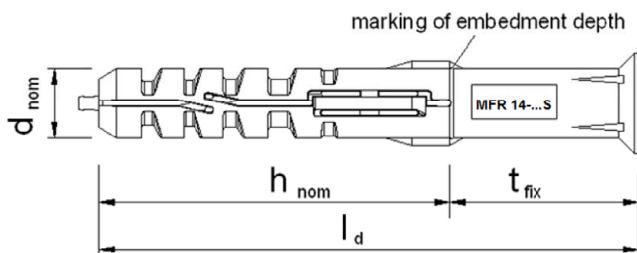

MFR 14 SB

Marking:	Brand	Type	diameter (d_{nom}) - length (l_d)		head form (optional)
Example:	MEA (or CELO or Logo)	MFR	14	- 110	F or S (F = FB) (S = SB)

Special screw (for MFR 14)

Screw head with different tool fittings

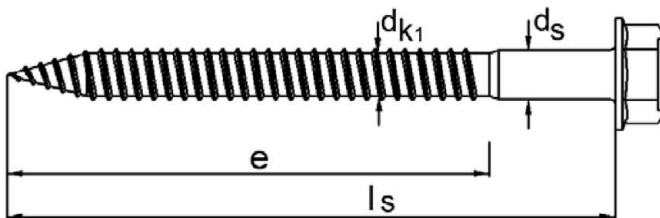

Type SSKS (or SSKS A4)
galvanised steel or stainless
steel (A4), optional with glide
coating



Type TX (or TX A4)
galvanised steel or stainless
steel (A4), optional with glide
coating

Marking:	Brand	Code No screw length	manufacturer code
Example:	X	11	1

CELO Multifunction frame plug MFR

Product description
Installed condition

Annex A5

Table A5.1: Dimension [mm]

Anchor sleeve								
	l_d	$\varnothing d_{nom}$	$t_{fix\ min}$	$t_{fix\ max}$	h_{nom1}	h_{nom2}	l_F ²⁾	$\varnothing d_F$
MFR 8	≥ 60	8	≥ 1	110	50		2,3	14
MFR 10	≥ 80	10	≥ 1	500	50	70	3	18
MFR 10-60	60	10	≥ 1	10	50		2	18
MFR 14	≥ 80	14	≥ 1	500	70		3	22

Special screw					
	l_s ¹⁾	$\varnothing d_s$	$\varnothing d_{k1}$	$\varnothing d_{k2}$	e
for MFR 8	≥ 65	6	5,2	-	48
for MFR 10	≥ 85	7	5,8	6,3	75
for MFR 10-60	65	7	5,8	-	48
for MFR 14	≥ 85	10	8,4	-	75

¹⁾ To insure, that the screw penetrates the anchor sleeve, l_s must be $l_d + 5$ mm

²⁾ only valid for plan head version

Table A5.2: Materials

Designation	Material
anchor sleeve	Polyamid PA 6
special screw (steel, zinc plated)	Steel, zinc plated galvanised $\geq 5\ \mu\text{m}$ acc. EN ISO 4042:1999 $f_{yk} \geq 480\ \text{N/mm}^2$, $f_{uk} \geq 600\ \text{N/mm}^2$ (≥ 6.8 screw)
special screw (stainless steel)	Stainless steel A4 according to EN 10088-3:2014, material 1.4401 or 1.4571 $f_{yk} \geq 450\ \text{N/mm}^2$, $f_{uk} \geq 700\ \text{N/mm}^2$ strength class 70

CELO Multifunction frame plug MFR

Product description
Dimensions and materials

Annex A6

Specifications of intended use

Anchorage subject to:

- Static and quasi-static loads.
- Multiple fixing of non-structural applications

Base materials:

- Reinforced or unreinforced normal weight concrete with strength classes \geq C12/15 (use category a) according to EN 206:2013, Annex C2.
- Precast prestressed hollow core slabs with strength classes \geq C20/25 (use category a) according to Annex C2
- Solid brick masonry (use category b) according to Annex C4-C6
Note: The characteristic resistance is also valid for larger brick sizes and higher compressive strength of the masonry unit.
- Hollow brick masonry (use category c) according to Annex C4-C6
- Aerated concrete (use category d) according to Annex C10
- Mortar strength class of the masonry \geq M2,5 according to EN 998-2:2010.
- For other base materials of the use categories a, b, c or d the characteristic resistance of the anchor may be determined by job site tests according to ETAG 020, Annex C, Edition March 2012.

Temperature Range for use:

- a: - 40° C to + 40° C (max. short term temperature + 40° C and max long term temperature + 24° C)
- b: - 40° C to + 80° C (max. short term temperature + 80° C and max long term temperature + 50° C)

Use conditions (Environmental conditions):

- Structures subject to dry internal conditions (screw with zinc coated steel, stainless steel)
- The specific screw made of galvanised steel may also be used in structures to external atmospheric exposure, if the area of the head of the screw is protected against moisture and driving rain after mounting of the fixing unit in this way, that intrusion of moisture into the anchor shaft is prevented. Therefore there shall be an external cladding or a ventilated rainscreen mounted in front of the head of the screw and the head of the screw itself shall be coated with a soft plastic, permanently elastic bitumen-oil-combination coating (e. g. undercoating or body cavity protection for cars)
- Structures subject to external atmospheric exposure (including industrial and marine environment) and to permanently damp internal condition, if no particular aggressive conditions exist (stainless steel).

Note: Particular aggressive conditions are e.g. permanent, alternating immersion in seawater or the splash zone of seawater, chloride atmosphere of indoor swimming pools or atmosphere with extreme chemical pollution (e.g. in desulphurization plants or road tunnels where de-icing materials are used).

Design:

- The anchorages are to be designed in accordance with ETAG 020, Annex C, Edition March 2012 under the responsibility of an engineer experienced in anchorages and masonry work.
- Verifiable calculation notes and drawings shall be prepared taking account of the loads to be anchored, the nature and strength of the base materials and the dimensions of the anchorage members as well as of the relevant tolerances. The position of the anchor is indicated on the design drawings.
- Fasteners are only to be used for multiple use for non-structural application according to ETAG 020, Annex C, Edition March 2012.

Installation:

- Hole drilling by the drill methods according to Annex C4, C5 or C6 for base material group b and c, hammer drilling is to use for base material group a.
- Anchor installation carried out by appropriately qualified personnel and under the supervision of the person responsible for technical matters of the site.
- Temperature of the plug at installation from 0°C to + 50°C.
- Exposure to UV due to solar radiation of the anchor not protected \leq 6 weeks.

CELO Multifunction frame plug MFR	Annex B1
Intended use Specification of intended use	

Table B2.1: Installation parameter in concrete, masonry and AAC

Anchor type			MFR 8	MFR 10-60/ MFR 10	MFR 10	MFR 14
Overall plastic anchor embedment depth in the base material ^{1), 2)}	$h_{nom} \geq$	[mm]	50	50	70	70
Drill hole diameter	$d_0 <$	[mm]	8	10		14
Cutting diameter of drill bit	$d_{cut} \leq$	[mm]	8,45	10,45		14,50
Depth of drill hole to the deepest point ¹⁾	$h_1 \geq$	[mm]	60	60	80	80
Diameter of clearance hole in the fixture	$d_f \leq$	[mm]	9,0	10,5		15

¹⁾ See Annex A1

²⁾ For hollow and perforated masonry the influence of
 $h_{nom} > 50$ mm (MFR 8)
 $h_{nom1} > 50$ mm respectively $h_{nom2} > 70$ mm (MFR 10)
 $h_{nom} > 70$ mm (MFR 14)
has to be detected by job site tests.

Table B2.2: Installation parameter in precast prestressed hollow core slabs

Anchor type			MFR 8	MFR 10-60/ MFR 10 $h_{nom1}=50$ mm	MFR 10 $h_{nom2}=70$ mm
Drill hole diameter	$d_0 <$	[mm]	8	10	10
Cutting diameter of drill bit	$d_{cut} \leq$	[mm]	8,45	10,45	10,45
Depth of drill hole to the deepest point ¹⁾	$h_1 \geq$	[mm]	60	60	80
Overall plastic anchor embedment depth in the concrete core slab	$h_{nom} \geq$	[mm]	50	50	70
Diameter of clearance hole in the fixture	$d_f \leq$	[mm]	9,0	10,5	10,5
Bottom flange thickness	$d_b \geq$	[mm]	35	35	35
Distance between plug position and prestressing steel	$a_p \geq$	[mm]	50	50	50

¹⁾ See Annex A1

CELO Multifunction frame plug MFR

Product description

Installation parameters in concrete, masonry, AAC and hollow core slabs

Annex B2

Table B3.1: Minimum thickness of member, edge distance and anchor spacing in concrete

- MFR 8:** Fixing points with a spacing $a \leq 55$ mm are considered as a group with a max. characteristic resistance $N_{Rk,p}$ acc. to Table C2.1. For $a > 55$ mm the anchors are considered as single anchors, each with a characteristic resistance $N_{Rk,p}$ acc. to Table C2.1. and C2.2.
- MFR 10:** Fixing points with a spacing $a \leq 75$ mm are considered as a group with a max. characteristic resistance $N_{Rk,p}$ acc. to Table C2.1. For $a > 75$ mm the anchors are considered as single anchors, each with a characteristic resistance $N_{Rk,p}$ acc. to Table C2.1. and C2.2.
- MFR 14:** Fixing points with a spacing $a \leq 80$ mm are considered as a group with a max. characteristic resistance $N_{Rk,p}$ acc. to Table C2.1. For $a > 80$ mm the anchors are considered as single anchors, each with a characteristic resistance $N_{Rk,p}$ acc. to Table C2.1.

	Minimum thickness h_{min} [mm]	Characteristic edge distance $c_{cr,N}$ [mm]	Minimum edge distances c_{min} [mm]	Minimum spacing s_{min} [mm]
MFR 8				
Concrete \geq C16/20	100	50	60	50
Concrete C12/15	100	70	85	70
MFR 10-60/ MFR 10 $h_{nom1} = 50$ mm				
Concrete \geq C16/20	100	50	50	50
Concrete \geq C12/15	100	70	70	70
MFR 10 $h_{nom2} = 70$ mm				
Concrete \geq C16/20	110	70	60	50
Concrete C12/15	110	100	85	70
MFR 14				
Concrete \geq C16/20	120	80	100	100
Concrete C12/15	120	112	140	140

Table B3.2: Minimum thickness of member, edge distance and anchor spacing in precast prestressed hollow core slabs

	Minimum thickness h_{min} [mm]	Characteristic edge distance $c_{cr,N}$ [mm]	Minimum edge distances c_{min} [mm]	Minimum spacing s_{min} [mm]
MFR 8				
Concrete \geq C45/55	200	50	60	50
MFR 10/ MFR 10-60 $h_{nom1}=50$ mm				
Concrete \geq C20/25	200	70	60	50
MFR 10 $h_{nom2}=70$ mm				
Concrete \geq C45/55	200	70	60	50

CELO Multifunction frame plug MFR

Intended use

Minimum thickness, spacing, edge distance in concrete and hollow core slabs

Annex B3

Table B4: Minimum thickness of member, edge distance and anchor spacing in masonry

Base material ¹⁾	Minimum thickness of member h_{min} [mm]	Minimum edge distance c_{min} [mm]	Single anchor a_{min} [mm]	Minimum spacing	
				Anchor Group ²⁾	
				perpendicular to free edge s_{1,min} [mm]	parallel to free edge s_{2,min} [mm]
MFR 8					
Clay brick Mz-1.8 - NF	115	100	250	200	400
Sand-lime solid brick KS - NF	115	100	250	200	400
Hollow clay brick HLz 12-1.0 - 12DF	240	100	250	200	400
Hollow sandlime brick KSL 12-1.4 - 3DF	175	100	250	200	400
Hollow light concrete bl. Hbl 2-0.8 - 16DF	240	100	250	200	400
Hollow concrete block Hbn 1.4 - 12DF	240	100	250	200	400
MFR 10-60/ MFR 10 h_{nom1} = 50 mm					
Clay brick Mz-1.8 2DF	115	100	250	200	400
Sand-lime solid brick KS - 3DF	175	100	250	200	400
Hollow clay brick HLz 12-1.0 - 12DF	240	100	250	200	400
Hollow sandlime brick KSL 12-1.4 - 8DF	240	100	250	200	400
Hollow concrete block Hbn 1.4 - 12DF	240	100	250	200	400
MFR 10 h_{nom2} = 70 mm					
Clay brick Mz-1.8 - 2DF	115	100	250	200	400
Sand-lime solid brick KS - 2DF	115	100	250	200	400
Hollow clay brick HLz 12-1.0 - 2DF	115	100	250	200	400
Hollow sandlime brick KSL 12-1.4 - 8DF	240	100	250	200	400
Hollow clay brick Brique Creuse C 3-0.7	200	100	250	200	400
Hollow concrete block Hbn 1.4 - 12DF	240	100	250	200	400
MFR 14					
Clay brick Mz-1.8 NF	115	100	250	200	400
Sand-lime solid brick KS - 8DF	240	100	250	200	400
Sand-lime solid brick KS - 2DF	115	100	250	200	400
Hollow clay brick HLz 12-1.0 - 2DF	115	120	250	240	480
Hollow sandlime brick KSL 12-1.4 - 8DF	240	100	250	200	400

¹⁾ Information for base material masonry: see Annex C4, Table C4

²⁾ The design method is valid for single anchors and anchor groups with two or four anchors.

CELO Multifunction frame plug MFR

Intended use
Minimum thickness, spacing, edge distance in masonry

Annex B4

**Table B5: Minimum thickness of member, edge distance and anchor spacing in AAC
(Autoclaved aerated concrete)**

MFR 10 and MFR 14 $h_{nom2}=70$ mm	Minimum thickness of member	Minimum edge distance	Minimum spacing		
			Single anchor	Anchor Group ¹⁾	
				perpendicular to free edge	parallel to free edge
Base material	h_{min} [mm]	c_{min} [mm]	a_{min} [mm]	$s_{1,min}$ [mm]	$s_{2,min}$ [mm]
EN 771-4 AAC 2	100	50	250	100	200
EN 771-4 AAC 4	100	75	250	150	300
EN 771-4 AAC 6	100	150	250	200	400

¹⁾ The design method is valid for single anchors and anchor groups with two or four anchors.

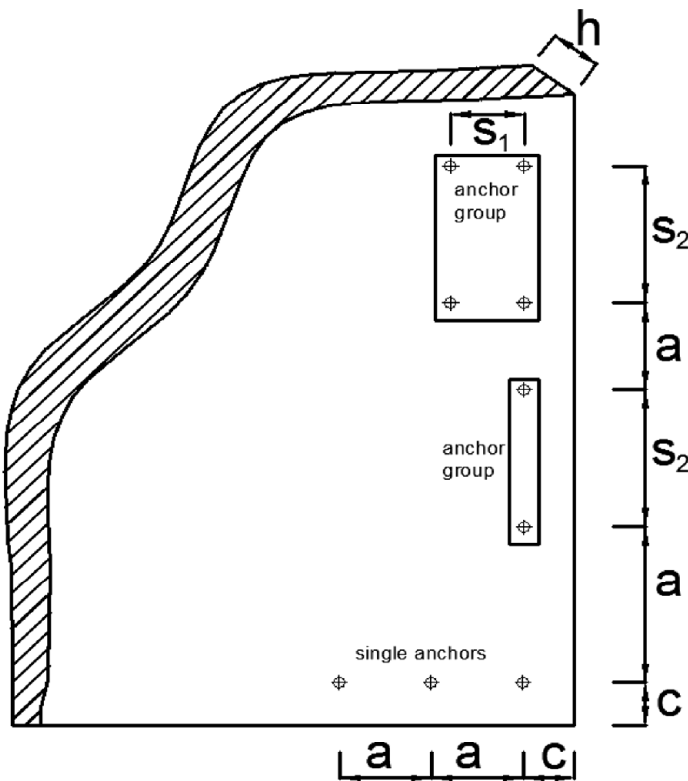

CELO Multifunction frame plug MFR

Intended use
Minimum thickness, spacing, edge distance in AAC

Annex B5

Table B6: Geometry of stones

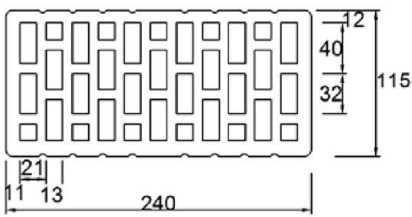

Fig. 1 HLZ 12 2DF

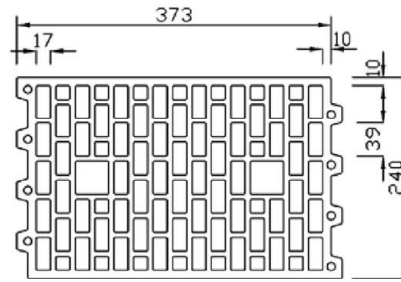

Fig. 2 HLZ 12 12DF

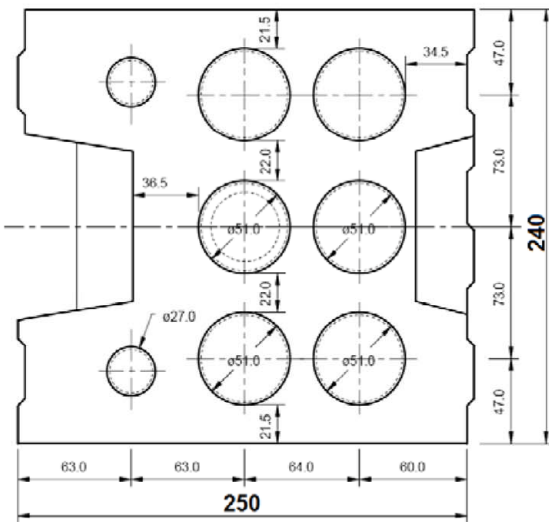

Fig. 3 KSL 12 8DF

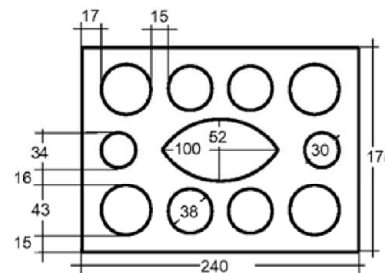

Fig. 4 KSL 12-1.4 - 3DF

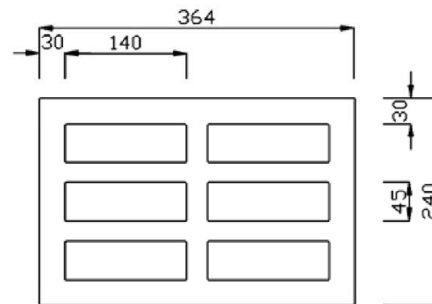

Fig. 6 HBN 1,4 12DF

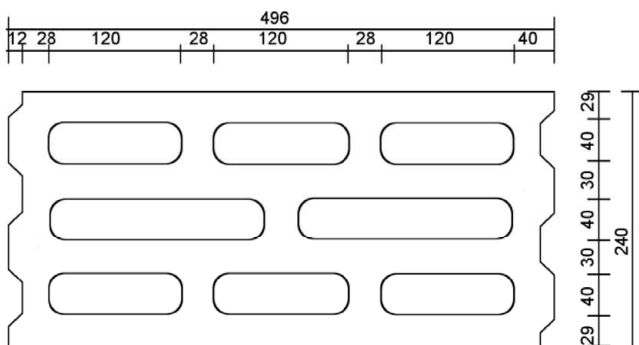

Fig. 5 HBL 2-0,8 16DF

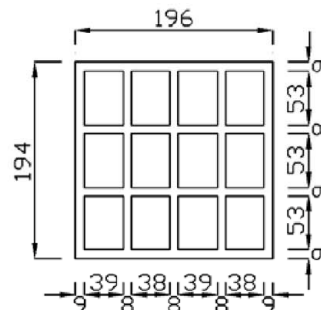

Fig. 7 Brique Creuse C

CELO Multifunction frame plug MFR

Intended use
Geometry of stones

Annex B6

Installation instruction MFR

**in concrete or in
hollow core slabs**

in masonry

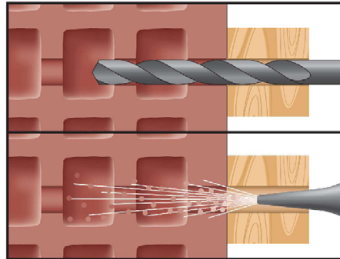
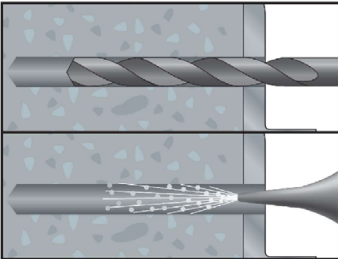

1. Drill the borehole and clean the hole.
Drilling method:
Concrete: hammer drill
Masonry: According Tab. C4, C5, C6

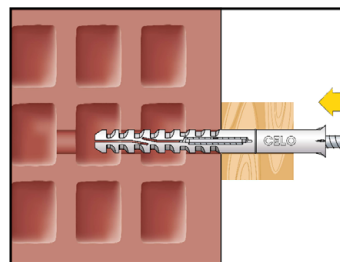
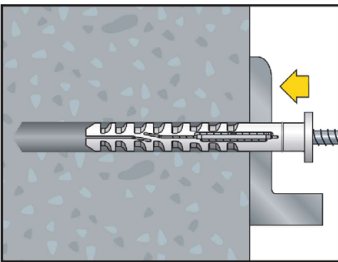

2. Hammer in the plug slightly through the fixture part till the plug is flush to this. Minimum setting depth (50 mm or 70 mm) must be observed.

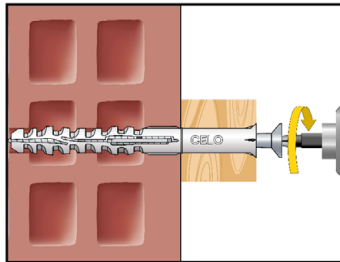
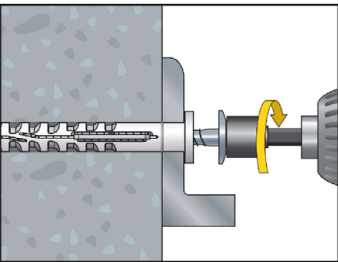

3. Tighten the screw with screw driver till the screw touches the collar of the sleeve. The screw must fit tight on the surface of the fixture part.

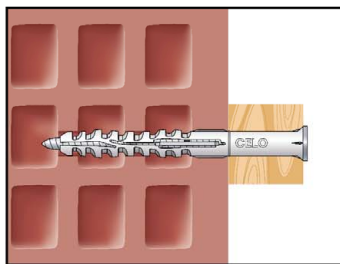
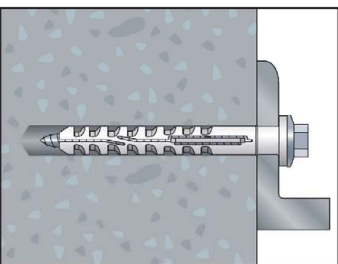

4. Correctly installed plug with screw in concrete or in masonry.

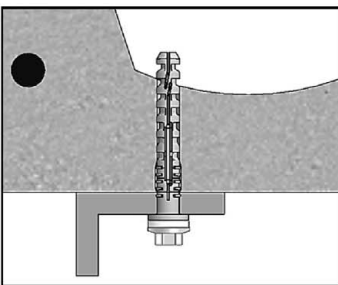

4. Correctly installed plug with screw in hollow concrete core slab.

Electronic copy of the ETA by DIBt: ETA-07/0337

CELO Multifunction frame plug MFR

Intended use
Installation instruction

Annex B7

Table C1.1: Characteristic bending resistance of the screw

Screw Ø 6 mm for MFR 8		galvanised steel	stainless steel
Characteristic bending resistance	$M_{Rk,s}$ [Nm]	8,8	10,3
Partial safety factor	γ_{Ms} ¹⁾	1,25	1,56
Screw Ø 7 mm for MFR 10-60/ MFR 10		galvanised steel	stainless steel
Characteristic bending resistance	$M_{Rk,s}$ [Nm]	15,3	17,8
Partial safety factor	γ_{Ms} ¹⁾	1,25	1,56
Screw Ø 10 mm for MFR 14		galvanised steel	stainless steel
Characteristic bending resistance	$M_{Rk,s}$ [Nm]	36,7	42,9
Partial safety factor	γ_{Ms} ¹⁾	1,25	1,56

¹⁾ in absence of other national regulations

Table C1.2: Characteristic resistance of the screw

Failure of expansion element (special screw)			
		galvanised steel	stainless steel
Special screw Ø 6 mm for MFR 8			
Characteristic tension resistance	$N_{Rk,s}$ [kN]	11,7	13,7
Partial safety factor	γ_{Ms} ¹⁾	1,5	1,87
Characteristic shear resistance	$V_{Rk,s}$ [kN]	5,8	6,8
Partial safety factor	γ_{Ms} ¹⁾	1,25	1,56
Special screw Ø 7 mm for MFR 10-60/ MFR 10		galvanised steel	stainless steel
Characteristic tension resistance	$N_{Rk,s}$ [kN]	17,0	19,8
Partial safety factor	γ_{Ms} ¹⁾	1,5	1,87
Characteristic shear resistance	$V_{Rk,s}$ [kN]	8,5	9,9
Partial safety factor	γ_{Ms} ¹⁾	1,25	1,56
Special screw Ø 10 mm for MFR 14		galvanised steel	stainless steel
Characteristic tension resistance	$N_{Rk,s}$ [kN]	30,5	35,5
Partial safety factor	γ_{Ms} ¹⁾	1,5	1,87
Characteristic shear resistance	$V_{Rk,s}$ [kN]	15,2	17,8
Partial safety factor	γ_{Ms} ¹⁾	1,25	1,56

¹⁾ in absence of other national regulations

CELO Multifunction frame plug MFR

Performances

Characteristic resistance and characteristic bending resistance of the screw

Annex C1

Table C2.1: Characteristic resistance for use in cracked and uncracked concrete

(use category "a")

Pull-out failure (plastic sleeve)			Concrete ≥ C16/20		Concrete C12/15	
			ϑ = 24/40 °C	ϑ = 50/80 °C	ϑ = 24/40 °C	ϑ = 50/80 °C
MFR 8						
Characteristic resistance	$N_{Rk,p}$	[kN]	2,5	2,5	1,5	1,5
Partial safety factor	$\gamma_{Mc}^{1)}$		1,8	1,8	1,8	1,8
MFR 10-60/ MFR 10 $h_{nom1} = 50$ mm						
Characteristic resistance	$N_{Rk,p}$	[kN]	2,5	2,0	1,5	1,5
Partial safety factor	$\gamma_{Mc}^{1)}$		1,8	1,8	1,8	1,8
MFR 10 $h_{nom2} = 70$ mm						
Characteristic resistance	$N_{Rk,p}$	[kN]	4,0	3,0	2,5	2,0
Partial safety factor	$\gamma_{Mc}^{1)}$		1,8	1,8	1,8	1,8
MFR 14						
Characteristic resistance	$N_{Rk,p}$	[kN]	4,5	3,0	3,0	2,0
Partial safety factor	$\gamma_{Mc}^{1)}$		1,8	1,8	1,8	1,8

¹⁾ In absence of other national regulations

Table C2.2: Characteristic resistance for use in precast prestressed hollow core slabs

(use category "a", temperature range a (+24°/ +40°) and b (+50°/ +80°))

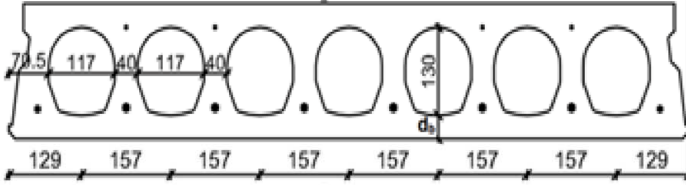
Pull-out failure (plastic sleeve)			Precast prestressed hollow core slabs	
			Producer: DW Systembau, D-29640 Schneverdingen or ANC TEC Leipzig	
MFR 8			Bottom flange thickness	
Concrete ≥ C45/55			$d_b \geq 35$ mm	3,50
Characteristic resistance	$N_{Rk,p}$	[kN]		
Partial safety factor	$\gamma_{Mc}^{1)}$			1,8
MFR 10-60/ MFR 10 $h_{nom1} = 50$ mm				
Concrete ≥ C20/25			$d_b \geq 35$ mm	2,00
Characteristic resistance	$N_{Rk,p}$	[kN]		
Partial safety factor	$\gamma_{Mc}^{1)}$			1,8
MFR 10 $h_{nom1} = 70$ mm				
Concrete ≥ C45/55			$d_b \geq 35$ mm	1,20
Characteristic resistance	$N_{Rk,p}$	[kN]		
Partial safety factor	$\gamma_{Mc}^{1)}$			1,8

¹⁾ In absence of other national regulations

CELO Multifunction frame plug MFR

Performances

Characteristic resistance for use in concrete and in precast hollow core slabs

Annex C2

Table C3.1: Displacements under tension and shear loading in concrete

Concrete \geq C16/20	Tension load			Shear load		
	N ¹⁾	δ_{N0}	$\delta_{N\infty}$	V ¹⁾	δ_{V0}	$\delta_{V\infty}$
MFR 8	[kN]	[mm]	[mm]	[kN]	[mm]	[mm]
temperature $\vartheta = 24/40$ °C	0,99	0,25	0,05	2,47	0,80	1,20
temperature $\vartheta = 50/80$ °C	0,99	0,25	0,06	2,47	0,80	1,20
MFR 10-60/ MFR 10 $h_{nom1} = 50$ mm						
temperature $\vartheta = 24/40$ °C	0,99	0,17	0,34	1,04	0,81	1,22
temperature $\vartheta = 50/80$ °C	0,79	0,14	0,29	0,83	0,69	1,04
MFR 10 $h_{nom2} = 70$ mm						
temperature $\vartheta = 24/40$ °C	1,59	0,12	0,15	3,37	2,20	3,30
temperature $\vartheta = 50/80$ °C	1,19	0,11	0,15	3,37	2,20	3,30
MFR 14						
temperature $\vartheta = 24/40$ °C	1,79	0,30	0,60	6,04	2,50	3,75
temperature $\vartheta = 50/80$ °C	1,19	0,25	0,50	6,04	2,50	3,75

¹⁾ Intermediate values by linear interpolation

Table C 3.2: Value under fire exposure in concrete C20/25 to C50/60 in any load direction, no permanent centric tension load and without lever arm, fastening of facade systems

Anchor type	Fire resistance class	$F_{RK,fi,90}$
MFR 10	R 90	0,8 kN
MFR 14	R 90	0,8 kN

CELO Multifunction frame plug MFR

Performances

Displacement under tension and shear loading in concrete,
Value under fire exposure

Annex C3

Table C4 : Characteristic resistance F_{Rk} [kN] in solid and hollow or perforated masonry
(use category "b" + "c") for MFR 8

MFR 8	Bulk density class ρ	Minimum compressive Strength f_b	Minimum DF or minimum size (L x W x H)	figure/ geometry	drill method H= hammer R= rotary	Characteristic resistance F_{Rk} ¹⁾ [kN] $\vartheta = 24/40$ °C $\vartheta = 50/80$ °C
Base material	[kg/dm ³]	[N/mm ²]	[mm]			
Clay brick Mz EN 771-1:2011+A1:2015	$\geq 1,8$	≥ 20	NF (240*115*71)		H	1,50
Clay brick Mz EN 771-1:2011+A1:2015	$\geq 1,8$	$10 \leq f_b < 20$	NF (240*116*71)		H	0,90
Sand-lime solid brick KS EN 771-2:2011+A1:2015	$\geq 1,8$	≥ 20	2DF (240*115*113)		H	3,00
Sand-lime solid brick KS EN 771-2:2011+A1:2015	$\geq 1,8$	$10 \leq f_b < 20$	2DF (240*115*113)		H	2,00
Hollow clay brick HLz EN 771-1:2011+A1:2015	1,0	12	12 DF (373*240*249)	Annex B6 figure 2	R only	0,50
Hollow Sand-lime brick KSL EN 771-2:2011+A1:2015	$\geq 1,4$	17	3 DF (240*175*113)	Annex B6 figure 4	R	1,20
		12				0,75
Hollow light concrete block Hbl EN 771-3:2011+A1:2015	$\geq 0,8$	2	16 DF 500*240*248	Annex B6 figure 5	R	0,30
Hollow concrete block Hbn EN 771-3:2011+A1:2015	$\geq 1,4$	25	12 DF 365*240*238	Annex B6 figure 6	H	1,20
Partial safety factor ²⁾					γ_{Mm}	2,5

¹⁾ Characteristic resistance for tension, shear or combined tension and shear loading

²⁾ In absence of other national regulations

CELO Multifunction frame plug MFR

Performances
MFR 8 – Characteristic resistance for use in masonry

Annex C4

Table C5: Characteristic resistance F_{Rk} [kN] in solid and hollow or perforated masonry
(use category "b" + "c") for MFR 10 and MFR 10-60

MFR 10-60/ MFR 10	Bulk density class ρ	Minimum compressive strength f_b	Minimum DF or minimum size (L x W x H)	figure/geo-metry	drill method	Characteristic resistance		Characteristic resistance	
						$F_{Rk}^{1)}$ [kN]		$F_{Rk}^{1)}$ [kN]	
						$h_{nom1} = 50$ mm		$h_{nom2} = 70$ mm	
Base material	[kg/dm ³]	[N/mm ²]	[mm]		H=hammer R=rotary	$\vartheta = 24/40$ °C	$\vartheta = 50/80$ °C	$\vartheta = 24/40$ °C	$\vartheta = 50/80$ °C
Clay brick Mz EN 771-1:2011+A1:2015	≥ 1,8	≥ 20	2DF (240*116*113)		H	3,0	2,5	3,0	2,5
Clay brick Mz EN 771-1:2011+A1:2015	≥ 1,8	10 ≤ f_b < 20	2DF (240*116*113)		H	2,0	1,5	2,0	1,5
Sand-lime solid brick KS EN 771-2:2011+A1:2015	≥ 1,8	≥ 20	2DF (240*115*113)		H	4,0	3,5	3,0	2,5
Sand-lime solid brick KS EN 771-2:2011+A1:2015	≥ 1,8	10 ≤ f_b < 20	2DF (240*115*113)		H	2,5	2,5	2,0	2,0
Hollow clay brick HLz EN 771-1:2011+A1:2015	≥ 1,0	12	2 DF (235*112*115)	Annex B6 figure 1	R only	3)	3)	0,75	0,60
Hollow clay brick HLz EN 771-1:2011+A1:2015	≥ 1,0	12	12 DF (373*240*249)	Annex B6 figure 2	R only	1,2	1,0	3)	3)
Hollow Sand-lime brick KSL EN 771-2:2011+A1:2015	≥ 1,4	12	8 DF (250*240*237)	Annex B6 figure 3	R	1,5	1,2	0,9	0,6
Hollow concrete block Hbn EN 771-3:2011+A1:2015	≥ 1,4	25	12 DF (365*240*238)	Annex B6 figure 6	H	2,5	2,0	0,75	0,75
Hollow clay brick Brique Creuse C LD 3-0,7-500x200x200 EN 771-1:2011+A1:2015	≥ 0,7	3	(496*196*194)	Annex B6 figure 7	R only	3)	3)	0,30	0,30
Partial safety factor ²⁾					γ_{Mm}	2,5			

- 1) Characteristic resistance for tension, shear or combined tension and shear loading
 2) In absence of other national regulations
 3) No performance assessed

CELO Multifunction frame plug MFR

Performances
MFR 10 – Characteristic resistance for use in masonry

Annex C5

**Table C6: Characteristic resistance F_{Rk} [kN] in solid and hollow or perforated masonry
(use category "b" + "c") for MFR 14**

MFR 14 Base material	Bulk density class ρ [kg/dm ³]	Minimum Compressive strength f_b [N/mm ²]	Minimum DF or minimum size (L x W x H) [mm]	figure/ geometry	drill method H= hammer R= rotary	Characteristic resistance F_{Rk} ¹⁾ [kN]	
						$\vartheta = 24/40$ °C	$\vartheta = 50/80$ °C
Clay brick Mz EN 771-1:2011+A1:2015	$\geq 1,8$	≥ 20	NF (240*116*71)		H	4,5	3,0
Clay brick Mz EN 771-1:2011+A1:2015	$\geq 1,8$	$10 \leq f_b < 20$	NF (240*116*71)		H	3,0	2,0
Sand-lime solid brick KS EN 771-2:2011+A1:2015	$\geq 1,8$	≥ 20	8 DF (250*240*237)		H	5,0	4,5
Sand-lime solid brick KS EN 771-2:2011+A1:2015	$\geq 1,8$	$10 \leq f_b < 20$	8 DF (250*240*237)		H	3,5	3,0
Sand-lime solid brick KS EN 771-2:2011+A1:2015	$\geq 1,8$	≥ 20	2 DF (240*115*113)		H	4,5	4,0
Sand-lime solid brick KS EN 771-2:2011+A1:2015	$\geq 1,8$	$10 \leq f_b < 20$	2 DF (240*115*113)		H	3,0	2,5
Hollow clay brick HLz EN 771-1:2011+A1:2015	$\geq 1,0$	12	2 DF (235*115*113)	Annex B6 figure 1	R only	0,75	0,5
Hollow Sand-lime brick KSL EN 771-2:2011+A1:2015	$\geq 1,4$	12	8 DF (250*240*237)	Annex B6 figure 3	R	1,2	0,75
Partial safety factor ²⁾					γ_{Mm}	2,5	

1) Characteristic resistance for tension, shear or combined tension and shear loading

2) In absence of other national regulations

CELO Multifunction frame plug MFR

Performances
MFR 14 – Characteristic resistance for use in masonry

Annex C6

**Table C7: Displacements under tension and shear loading in masonry
for temperature $\vartheta = 24/40$ °C**

Base material	Displacements			Displacements		
	Tension load			Shear load		
	N	δ_{NO}	$\delta_{N\infty}$	V	δ_{VO}	$\delta_{V\infty}$
	[kN]	[mm]	[mm]	[kN]	[mm]	[mm]
MFR 8						
Clay brick Mz - NF	0,26	0,02	0,04	0,26	0,22	0,33
Sand-lime solid brick KS – 2 DF	0,57	0,33	0,66	0,57	0,48	0,72
Hollow clay brick HLz 12	0,14	0,01	0,02	0,42	0,08	0,12
Hollow Sand-lime brick KSL 12	0,25	0,11	0,22	0,20	0,37	0,55
Hollow light concrete block Hbl 2	0,09	0,02	0,04	0,13	0,02	0,03
Hollow concrete block Hbn	0,08	0,02	0,04	0,09	0,08	0,11
MFR 10-60/ MFR 10 $h_{nom1} = 50$ mm						
Clay brick Mz – 2DF	0,86	0,08	0,15	0,86	0,71	1,06
Sand-lime solid brick KS – 2DF	1,57	0,13	0,26	1,57	1,11	1,67
Hollow clay brick HLz 12-1.0	0,34	0,02	0,04	0,34	0,21	0,31
Hollow Sand-lime brick KS L 12-1,4	0,43	0,08	0,17	0,43	0,29	0,43
Hollow concrete block Hbn	0,71	0,29	0,58	0,71	0,62	0,93
MFR 10 $h_{nom2} = 70$ mm						
Clay brick Mz – 2DF	0,86	0,2	0,4	0,86	0,71	1,07
Sand-lime solid brick KS – 2DF	0,86	0,2	0,4	0,86	0,71	1,07
Hollow clay brick HLz 12-1.0	0,21	0,1	0,2	0,21	0,43	0,64
Hollow Sand-lime brick KSL 12-1,4	0,26	0,1	0,2	0,26	0,51	0,77
Brique Creuse C LD 3-0,7	0,09	0,2	0,4	0,09	0,17	0,26
Hollow concrete block Hbn	0,08	0,01	0,02	0,23	0,16	0,23
MFR 14						
Clay brick Mz - NF	1,29	0,2	0,4	1,29	1,07	1,61
Sand-lime solid brick KS - 8 DF	1,43	0,2	0,4	1,43	1,19	1,79
Sand-lime solid brick KS - 2 DF	1,29	0,2	0,4	1,29	1,07	1,61
Hollow clay brick HLz 12 - 1.0	0,21	0,1	0,2	0,21	0,43	0,64
Hollow Sand-lime brick KS L 12 - 1,4	0,34	0,1	0,2	0,34	0,69	1,03

CELO Multifunction frame plug MFR

Performances

Displacement for use in masonry, temperature $\vartheta = 24/40$ °C

Annex C7

Table C8: Displacements under tension and shear loading in masonry
for temperature $\vartheta = 50/80$ °C

Base material	Displacements			Displacements		
	Tension load			Shear load		
	N	δ_{N0}	$\delta_{N\infty}$	V	δ_{V0}	$\delta_{V\infty}$
	[kN]	[mm]	[mm]	[kN]	[mm]	[mm]
MFR 8						
Clay brick Mz - NF	0,26	0,02	0,04	0,26	0,22	0,33
Sand-lime solid brick KS – 2 DF	0,57	0,33	0,66	0,57	0,48	0,72
Hollow clay brick HLz 12	0,14	0,01	0,02	0,42	0,08	0,12
Hollow Sand-lime brick KSL 12	0,25	0,11	0,22	0,20	0,37	0,55
Hollow light concrete block Hbl 2	0,09	0,02	0,04	0,13	0,02	0,03
Hollow concrete block Hbn	0,08	0,02	0,04	0,09	0,08	0,11
MFR 10-60/ MFR 10 $h_{nom1} = 50$ mm						
Clay brick Mz – 2DF	0,71	0,06	0,13	0,71	0,62	0,93
Sand-lime solid brick KS – 2DF	1,29	0,10	0,20	1,29	0,96	1,44
Hollow clay brick HLz 12-1.0	0,34	0,27	0,56	0,34	0,28	0,42
Hollow Sand-lime brick KS L 12-1,4	0,34	0,27	0,56	0,34	0,28	0,42
Hollow concrete block Hbn	0,57	0,27	0,55	0,57	0,52	0,77
MFR 10 $h_{nom2} = 70$ mm						
Clay brick Mz – 2DF	0,71	0,2	0,4	0,71	0,60	0,89
Sand-lime solid brick KS – 2DF	0,71	0,2	0,4	0,71	0,60	0,89
Hollow clay brick HLz 12-1.0	0,17	0,1	0,2	0,17	0,34	0,51
Hollow Sand-lime brick KSL 12-1,4	0,17	0,1	0,2	0,17	0,34	0,51
Brique Creuse C LD 3-0,7	0,09	0,2	0,4	0,09	0,17	0,26
Hollow concrete block Hbn	0,08	0,01	0,02	0,23	0,16	0,23
MFR 14						
Clay brick Mz - NF	0,86	0,2	0,4	0,86	0,71	1,07
Sand-lime solid brick KS - 8 DF	1,29	0,2	0,4	1,29	1,07	1,61
Sand-lime solid brick KS - 2 DF	1,14	0,2	0,4	1,14	0,95	1,43
Hollow clay brick HLz 12 - 1.0	0,14	0,1	0,2	0,14	0,29	0,43
Hollow Sand-lime brick KS L 12 - 1,4	0,21	0,1	0,2	0,21	0,43	0,64

CELO Multifunction frame plug MFR

Performances

Displacement for use in masonry, temperature $\vartheta = 50/80$ °C

Annex C8

Base material solid masonry: Autoclaved Aerated Concrete (AAC)

Table C9.1: Brick Data

Description of brick			AAC
Type of brick			Autoclaved Aerated Concrete AAC
Bulk density	$\rho \geq$	[kg/dm ³]	0,35
European Standard			EN 771-4:2011+A1:2015
Minimum thickness of member	$h_{\min} =$	[mm]	100

Installation parameters see Annex B2

Table C9.2: Characteristic resistance F_{Rk} [kN] in AAC

Base material	Drill method		Characteristic resistance F_{Rk} ¹⁾	
			$\vartheta = 24/40$ °C	$\vartheta = 50/80$ °C
MFR 10 $h_{nom2} = 70$ mm				
AAC 2	Hammer drilling	[kN]	0,4	0,3
AAC 4	Hammer drilling	[kN]	1,2	0,9
AAC 6	Hammer drilling	[kN]	2,0	1,5
MFR 14				
AAC 2	Hammer drilling	[kN]	0,3	0,3
AAC 4	Hammer drilling	[kN]	1,2	1,2
AAC 6	Hammer drilling	[kN]	2,0	2,0
Partial safety factor ²⁾	$\gamma_{M,AAC}$	[-]	2,0	2,0

1) Characteristic resistance F_{Rk} for tension, shear or combined tension and shear loading

2) In absence of other national regulations

CELO Multifunction frame plug MFR

Performances

MFR 10/14 – Characteristic resistance for use in autoclaved aerated concrete

Annex C9

Table C10: Displacements under tension and shear loading in AAC

Base material	Temperature range	Tension load			Shear load			
		N [kN]	δ_{N0} [mm]	$\delta_{N\infty}$ [mm]	V [kN]	δ_{V0} [mm]	$\delta_{V\infty}$ [mm]	
MFR 10 $h_{nom2} = 70$ mm								
AAC 2	temperature = 24/40 °C	9	0,14	0,1	0,2	0,14	0,3	0,4
	temperature = 50/80 °C	9	0,11	0,1	0,2	0,11	0,2	0,3
AAC 4	temperature = 24/40 °C	9	0,43	0,1	0,2	0,43	0,9	1,3
	temperature = 50/80 °C	9	0,32	0,1	0,2	0,32	0,6	1,0
AAC 6	temperature = 24/40 °C	9	0,71	0,1	0,2	0,71	1,4	2,1
	temperature = 50/80 °C	9	0,54	0,1	0,2	0,54	1,1	1,6
MFR 14								
AAC 2	9 = 24/40 °C and 9 = 50/80 °C		0,11	0,1	0,2	0,11	0,2	0,3
AAC 4	9 = 24/40 °C and 9 = 50/80 °C		0,43	0,1	0,2	0,43	0,9	1,3
AAC 6	9 = 24/40 °C and 9 = 50/80 °C		0,71	0,1	0,2	0,71	1,4	2,1

CELO Multifunction frame plug MFR

Performances
MFR 10/14 – Displacement for use in AAC under tension and shear load

Annex C10