

Approval body for construction products
and types of construction

Bautechnisches Prüfamt

An institution established by the Federal and
Laender Governments



European Technical Assessment

ETA-20/0339
of 28 July 2020

English translation prepared by DIBt - Original version in German language

General Part

Technical Assessment Body issuing the
European Technical Assessment:

Deutsches Institut für Bautechnik

Trade name of the construction product

Knauf Screw Anchor KSA

Product family
to which the construction product belongs

Mechanical fastener for use in concrete

Manufacturer

Hilti Aktiengesellschaft
9494 SCHAAN
FÜRSTENTUM LIECHTENSTEIN

Manufacturing plant

Hilti Werke

This European Technical Assessment
contains

22 pages including 3 annexes which form an integral part
of this assessment

This European Technical Assessment is
issued in accordance with Regulation (EU)
No 305/2011, on the basis of

EAD 330011-00-0601, Edition 07/2014 and
EAD 330232-01-0601, Edition 12/2019

This version replaces

ETA-20/0339 issued on 19 June 2020

The European Technical Assessment is issued by the Technical Assessment Body in its official language. Translations of this European Technical Assessment in other languages shall fully correspond to the original issued document and shall be identified as such.

Communication of this European Technical Assessment, including transmission by electronic means, shall be in full. However, partial reproduction may only be made with the written consent of the issuing Technical Assessment Body. Any partial reproduction shall be identified as such.

This European Technical Assessment may be withdrawn by the issuing Technical Assessment Body, in particular pursuant to information by the Commission in accordance with Article 25(3) of Regulation (EU) No 305/2011.

Specific Part

1 Technical description of the product

The Knauf screw anchor KSA is an anchor made of galvanised steel of sizes 6 and 8. The anchor is screwed into a predrilled cylindrical drill hole. The special thread of the anchor cuts an internal thread into the member while setting. The anchorage is characterised by mechanical interlock in the special thread.

The product description is given in Annex A.

2 Specification of the intended use in accordance with the applicable European Assessment Document

The performances given in Section 3 are only valid if the anchor is used in compliance with the specifications and conditions given in Annex B.

The verifications and assessment methods on which this European Technical Assessment is based lead to the assumption of a working life of the anchor of at least 50 years. The indications given on the working life cannot be interpreted as a guarantee given by the producer, but are to be regarded only as a means for choosing the right products in relation to the expected economically reasonable working life of the works.

3 Performance of the product and references to the methods used for its assessment

3.1 Mechanical resistance and stability (BWR 1)

Essential characteristic	Performance
Characteristic resistance to tension load (static and quasi-static loading)	See Annex B4, C1
Characteristic resistance to shear load (static and quasi-static loading)	See Annex C2
Characteristic resistance and displacements for seismic performance Category C1 and C2	See Annex C3, C4 and C7
Displacements (static and quasi-static loading)	See Annex C6
Durability	See Annex B1

3.2 Safety in case of fire (BWR 2)

Essential characteristic	Performance
Reaction to fire	Class A1
Resistance to fire	See Annex C5

4 Assessment and verification of constancy of performance (AVCP) system applied, with reference to its legal base

In accordance with the European Assessment Document EAD 330232-01-0601 and the European Assessment Document EAD 330011-00-0601 the applicable European legal act is: [96/582/EC].

The system to be applied is: 1

English translation prepared by DIBt

5 Technical details necessary for the implementation of the AVCP system, as provided for in the applicable European Assessment Document

Technical details necessary for the implementation of the AVCP system are laid down in the control plan deposited with Deutsches Institut für Bautechnik.

Issued in Berlin on 28 July 2020 by Deutsches Institut für Bautechnik

BD Dipl.-Ing. Andreas Kummerow
Head of Department

beglaubigt:
Baderschneider

Installed condition without adjustment

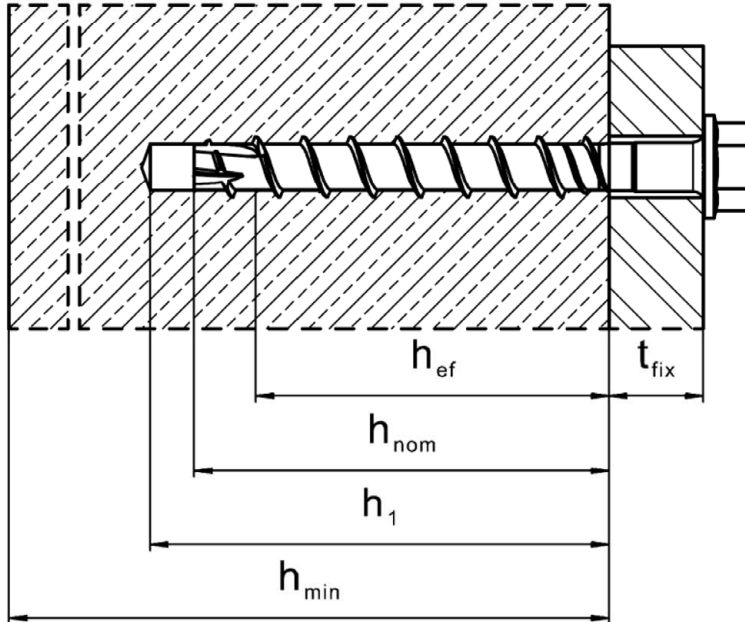

KSA (hexagon head configuration sizes 6 and 8)

Installed condition with adjustment

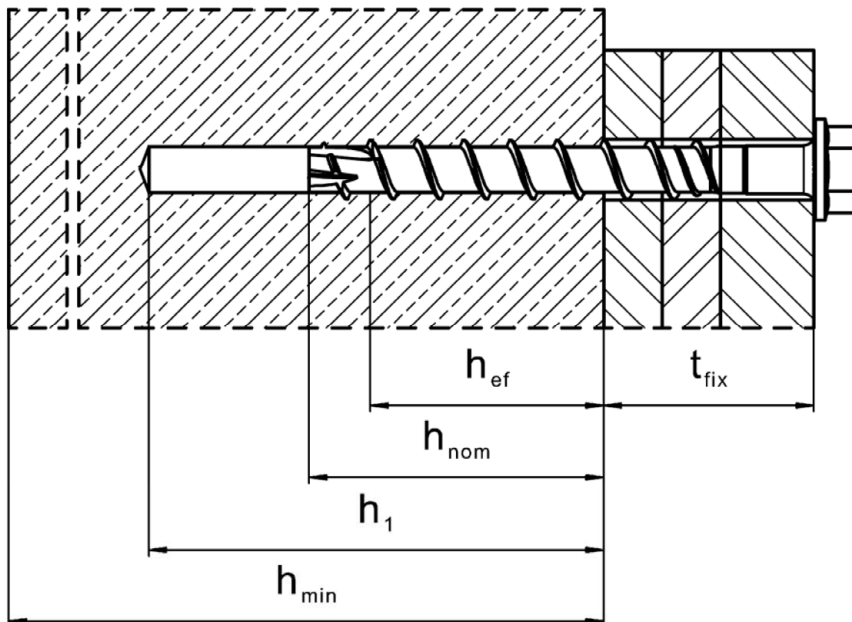

KSA (hexagon head configuration size 8 – h_{nom2} , h_{nom3})

Knauf screw anchor KSA

Product description
Installed condition

Annex A1

Table A1: Screw types

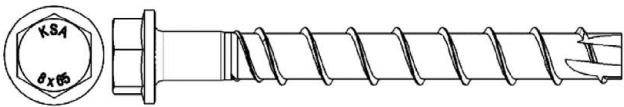
	<p>Knauf KSA, sizes 6 and 8, hexagonal head configuration, galvanized</p>
---	---

Hilti filling set

Sealing washer

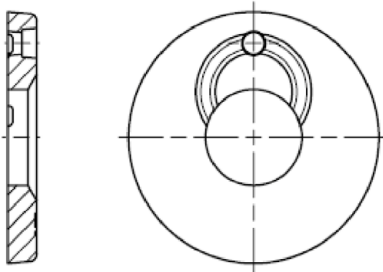

Spherical washer

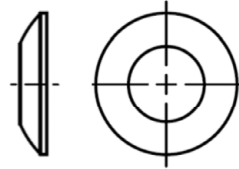

Injection mortar Hilti HIT-HY 200-A
Foil pack 330 ml and 500 ml

Marking:
HILTI HIT
Production number and
production line
Expiry date mm/yyyy



Product name: "Hilti HIT-HY 200-A"

Static mixer Hilti HIT-RE-M



Knauf screw anchor KSA

Production description
Screw types
Components of filling set

Annex A2

Table A2: Materials

Part	Designation	Material	
KSA screw anchor	Size 6 all lengths	$f_{yk} \geq 745 \text{ N/mm}^2$, $f_{uk} \geq 930 \text{ N/mm}^2$	Carbon steel Rupture elongation $A_5 \leq 8\%$
	Size 8 all lengths	$f_{yk} \geq 695 \text{ N/mm}^2$, $f_{uk} \geq 810 \text{ N/mm}^2$	

Table A3: Fastener dimensions and marking

Fastener size KSA	6		8		
	h_{nom1}	h_{nom2}	h_{nom1}	h_{nom2}	h_{nom3}
Nominal embedment depth [mm]	40	55	50	60	70
Threaded outer diameter d_t [mm]	7,85		10,30		
Core diameter d_k [mm]	5,85		7,85		
Shaft diameter d_s [mm]	6,15		8,45		
Stressed section A_s [mm ²]	26,9		48,4		

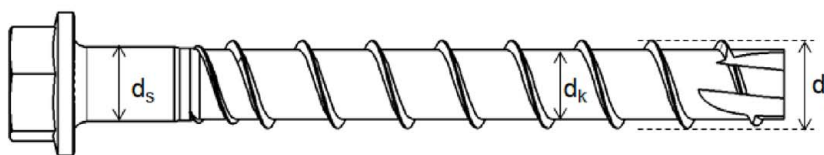

KSA : Knauf screw anchor

8 : screw diameter

65 : screw length



Knauf screw anchor KSA

Production description
Materials and fastener dimensions

Annex A3

Table A4: Hilti filling washer dimensions

Fastener size	Hilti filling set size	Hilti filling washer	
		Diameter d_{vs} [mm]	Thickness h_{vs} [mm]
KSA 8	M10	42	5

Hilti filling washer

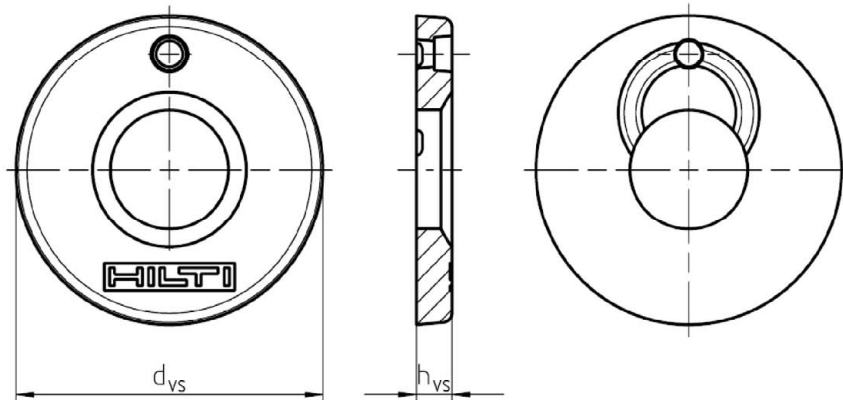

Knauf screw anchor KSA

Production description
Filling washer dimensions

Annex A4

Specifications of intended use

Anchorage subject to:

- Static and quasi-static loadings: all sizes and all embedment depths.
- Seismic action for performance category C1:
KSA size 6, standard and maximum embedment depth (h_{nom1} , h_{nom2}).
KSA size 8, standard and maximum embedment depth (h_{nom2} , h_{nom3}).
- Seismic action for performance category C2:
KSA sizes 8, maximum embedment depth (h_{nom3}).
- Fire exposure: All sizes and all embedment depths.

Base materials:

- Compacted, reinforced or unreinforced normal weight concrete without fibres according to EN 206:2013+A1:2016.
- Strength classes C20/25 to C50/60 according to EN 206:2013+A1:2016.
- Uncracked or cracked concrete.

Use conditions (Environmental conditions):

- Anchorages subject to dry internal conditions.

Design:

- Anchorages are designed under the responsibility of an engineer experienced in anchorages and concrete work.
- Verifiable calculation notes and drawings are prepared taking account of the loads to be anchored. The position of the fastener is indicated on the design drawings (e. g. position of the fastener relative to reinforcement or to supports, etc.).
- The anchorages are designed in accordance to EN 1992-4:2018 and Technical Report TR 055, Edition February 2018
- Fasteners with an effective embedment depth less than 40 mm shall be used under dry internal exposure conditions for fixing of statically indeterminate structural components only, when the load in case of failure of one fastener can be distributed to other fasteners.

Knauf screw anchor KSA

Intended use
Specifications

Annex B1

Specifications of intended use

Installation:

- Hammer drilling: all sizes and all embedment depths.
- Fastener installation carried out by appropriately qualified personnel and under the supervision of the person responsible for technical matters of the site.
- In case of aborted hole: new drilling at a minimum distance away of twice the depth of the aborted hole or smaller distance if the aborted hole is filled with high strength mortar and if under shear or oblique tension load it is not the direction of the load application.
- After installation further turning of the fastener must not be possible.
- The head of the fastener must be supported on the fixture and is not damaged.
- Adjustability according to Annex B7 for:
KSA size 8 ($h_{nom2} = 60$ mm and $h_{nom3} = 70$ mm)
- Installation with Hilti filling set according to Annex B6.

Knauf screw anchor KSA	Annex B2
Intended use Specifications	

Table B1: Installation parameters

Fastener size KSA		6		8		
Nominal embedment depth	h_{nom} [mm]	40	55	50	60	70
Nominal drill hole diameter	d_0 [mm]	6		8		
Cutting diameter of drill bit	$d_{cut} \leq$ [mm]	6,40		8,45		
Clearance hole diameter	$d_f \leq$ [mm]	9		12		
Wrench size	SW [mm]	13		13		
Countersunk head diameter	d_h [mm]	-		18		
Depth of drill hole in floor/ wall position	$h_1 \geq$ [mm]	50	65	60	70	80
Depth of drill hole in ceiling position	$h_1 \geq$ [mm]	43	58	-	80	90
Installation Torque	T_{inst} [Nm]	20	25	-		
Setting tool ¹⁾	Strength class \geq C20/25	Hilti SIW 14 A or Hilti SIW 22 A		Hilti SIW 14 A or Hilti SIW 22 A or Hilti SIW 22 T-A		

¹⁾ Installation with other impact screw driver of equivalent power is possible.

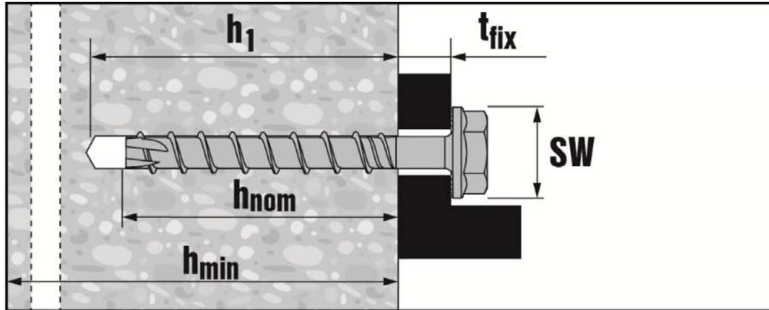

Installation parameters for KSA

Knauf screw anchor KSA

Intended use
Installation parameters

Annex B3

Table B2: Minimum thickness of concrete member, minimum edge distance and spacing

Fastener size KSA				6		8		
				h_{nom1}	h_{nom2}	h_{nom1}	h_{nom2}	h_{nom3}
Nominal embedment depth	h_{nom}	[mm]	40	55	50	60	70	
Minimum thickness of concrete member	h_{min}	[mm]	80	100	100	100	120	
Cracked and non-cracked concrete	Minimum spacing	s_{min}	35	35	50	50	50	
					40 if $c \geq 50$			
	Minimum edge distance	c_{min}	[mm]	35	35	40	40	40

Table B3: Standard¹⁾ screw lengths and maximum thickness of fixture

Fastener size KSA		6		8		
		h_{nom1} 40	h_{nom2} 55	h_{nom1} 50	h_{nom2} 60	h_{nom3} 70
Nominal embedment depth [mm]	Length of screw [mm]	Thickness of fixture [mm]				
		t_{fix1}	t_{fix2}	t_{fix1}	t_{fix2}	t_{fix3}
	45	5	-	-	-	-
	55	-	-	5	-	-
	60	20	5	-	-	-
	65	-	-	15	5	-
	75	-	-	25	15	5
	80	40	25	-	-	-
	85	-	-	35	25	15
	100	60	45	50	40	30
	120	80	65	70	60	50
	150	-	-	100	90	80

¹⁾ non-standard lengths, in the range $45 \text{ mm} \leq L \leq 150 \text{ mm}$, are also in the scope of this ETA.

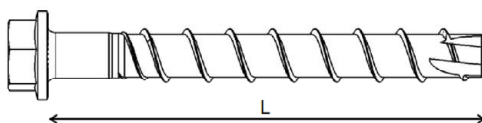

Knauf screw anchor KSA

Intended use

Minimum concrete thickness and minimum edge distance and spacing
Standard screw lengths and thickness of fixture

Annex B4

Installation instructions

Hole drilling

Hammer drilling (HD):

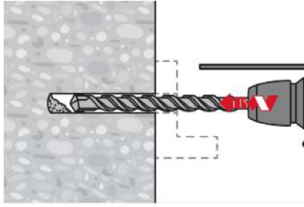

Drill hole cleaning

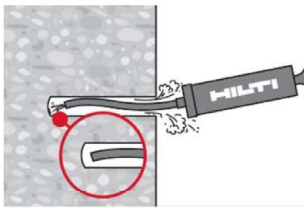

Clean the drill hole.

Hole cleaning is not required when 3x ventilation¹⁾ after drilling is executed and one of the following conditions is fulfilled:

- drilling is in the vertical upwards orientation; or
- drilling is in vertical downwards direction and the drilling depth is increased²⁾ by additional $3 \cdot d_0$.

¹⁾ Moving the drill bit in and out of the drill hole 3 times after the recommended drilling depth h_1 is achieved. This procedure shall be done with both revolution and hammer functions activated in the drilling machine. For more details read the relevant Instruction for use.

²⁾ It shall be ensured that the thickness of the concrete member h fulfills the following equation:

$$h \geq h_1 + \Delta h, \text{ with } \Delta h = \max(2 \cdot d_0; 30 \text{ mm}).$$

Δh is the minimum distance between the drilling end and the opposite end of the concrete member.

Fastener setting

a) Setting by impact screw driver

b) Setting by torque wrench

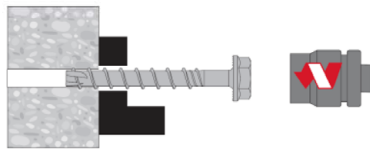

Setting parameters listed in Table B1

Setting check

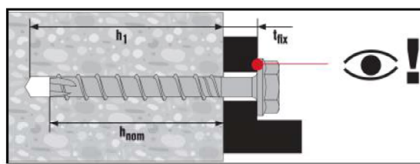

Knauf screw anchor KSA

Intended use

Installation instructions without adjustment

Annex B5

Fastener setting with Hilti filling set

Installation of sealing washer

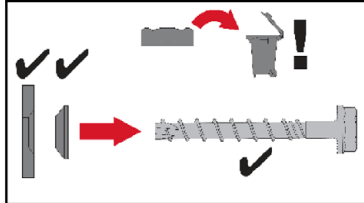

Size Seismic Set	Size KSA	t_{fix} , effective (mm)
M10	8	$t_{fix} - 7$ mm

The maximum fixture thickness t_{fix} is reduced by the overall thickness of the Hilti Filling Set after installation.

Setting by impact screw driver

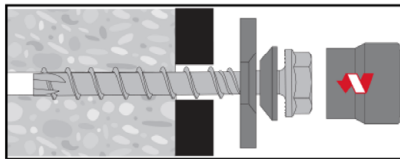

Setting check

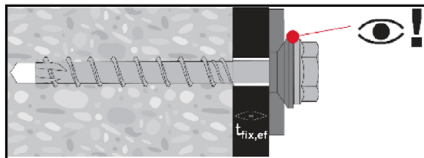

Injection of mortar

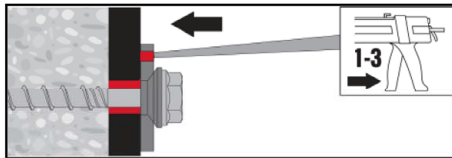

Table B4: Maximum working time and minimum curing time HY 200-A

Temperature in the base material T	Maximum working time t_{work}	Minimum curing time t_{cure}
> 0 °C to 5 °C	25 min	2 h
> 5 °C to 10 °C	15 min	75 min
> 10 °C to 20 °C	7 min	45 min
> 20 °C to 30 °C	4 min	30 min
> 30 °C to 40 °C	3 min	30 min

Knauf screw anchor KSA

Intended use

Installation instructions with Hilti filling set

Annex B6

Fastener setting with adjustment

Drilling depth and fixture thickness

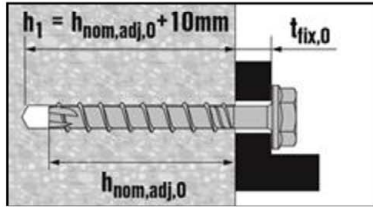

Adjusting process

1st step

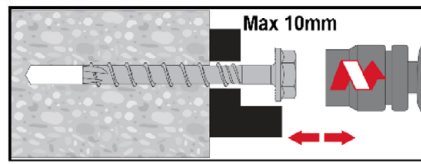
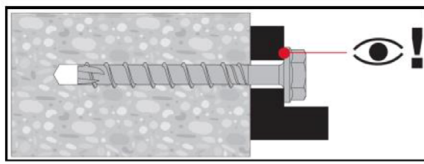

2nd step

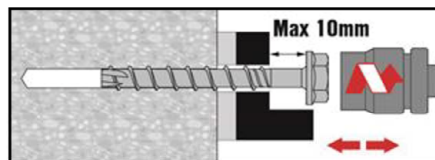
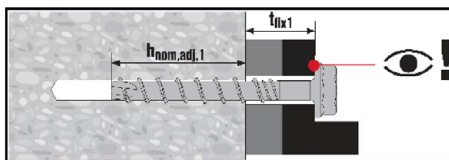

Setting check

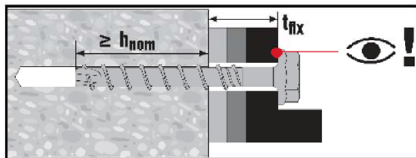

A screw can be adjusted maximum two times. The total allowed thickness of shims added during the adjustment process is 10 mm. The final embedding depth after adjustment process must be larger or equal than h_{nom2} or h_{nom3} .

Knauf screw anchor KSA

Intended use

Installation instructions with adjustment

Annex B7

Table C1: Characteristic values under static and quasi-static tension and shear loads

Fastener size KSA			6		8		
			h_{nom1}	h_{nom2}	h_{nom1}	h_{nom2}	h_{nom3}
Nominal embedment depth	h_{nom}	[mm]	40	55	50	60	70
Adjustment							
Total max. thickness of adjustment layers	t_{adj}	[mm]	..2)	..2)	..2)	10	10
Max. number of adjustments	n_a	[-]	..2)	..2)	..2)	2	2
Steel failure for tension load							
Characteristic resistance	$N_{Rk,s}$	[kN]	24		39,2		
Partial factor	$\gamma_{Ms,N}^{1)}$	[-]	1,4				
Pull-out failure							
Characteristic resistance in non-cracked concrete C20/25	$N_{Rk,p}$	[kN]	7	9	9	12	16
Characteristic resistance in cracked concrete C20/25	$N_{Rk,p}$	[kN]	2,5	6	6	9	12
Increasing factor for concrete ψ_c	C30/37	[-]	1,22				
	C40/50	[-]	1,41				
	C50/60	[-]	1,58				
Concrete cone and splitting failure							
Effective embedment depth	h_{ef}	[mm]	30	42	40	46,4	54,9
Characteristic resistance to prevent splitting	$N_{Rk,sp}^0$	[kN]	7	9	9	12	16
Factor for	Cracked	$k_{cr,N}$	7,7				
	Non-cracked	$k_{ucr,N}$	11,0				
Concrete cone failure	Edge distance	$c_{cr,N}$	1,5 h_{ef}				
	Spacing	$s_{cr,N}$	3 h_{ef}				
Splitting failure	Edge distance	$c_{cr,sp}$	60	63	60	70	85
	Spacing	$s_{cr,sp}$	120	126	120	140	170
Installation factor	γ_{inst}	[-]	1,2		1,0		

1) In absence of other national regulations.

2) No performance assessed.

Knauf screw anchor KSA

Performances

Characteristics values under static and quasi-static tension and shear loads in concrete

Annex C1

Table C1 continued

Fastener size KSA			6		8		
			h_{nom1}	h_{nom2}	h_{nom1}	h_{nom2}	h_{nom3}
Nominal embedment depth	h_{nom}	[mm]	40	55	50	60	70
Adjustment							
Total max. thickness of adjustment layers	t_{adj}	[mm]	-2)	-2)	-2)	10	10
Max. number of adjustments	n_a	[-]	-2)	-2)	-2)	2	2
Steel failure for shear load							
Characteristic resistance	$V^{0}_{RK,S}$	[kN]	12,5		19		22
Partial factor	$\gamma_{Ms,V}^{1)}$	[-]	1,5				
Ductility factor	k_7	[-]	0,8				
Characteristic resistance	$M^{0}_{RK,S}$	[Nm]	21		46		
Concrete pry-out failure							
Pry-out factor	k_8	[-]	1,0	1,5	1,0	2,0	
Concrete edge failure							
Effective length of fastener	$l_f = h_{ef}$	[mm]	30	42	40	46,4	54,9
Outside diameter of fastener	d_{nom}	[mm]	6		8		

¹⁾ In absence of other national regulations.

²⁾ No performance assessed

Knaf screw anchor KSA

Performances

Characteristics values under static and quasi-static tension and shear loads in concrete

Annex C2

Table C2: Characteristic values under seismic loading, performance category C1

Fastener size KSA			6		8	
			h_{nom1}	h_{nom2}	h_{nom2}	h_{nom3}
Nominal embedment depth	h_{nom}	[mm]	40	55	60	70
Steel failure for tension and shear load						
Characteristic resistance	$N_{Rk,s,C1}$	[kN]	24		39,2	
Partial factor	$\gamma_{Ms,N}^{1)}$	[-]	1,4			
Characteristic resistance	$V_{Rk,s,C1}$	[kN]	5		11,9	
Partial factor	$\gamma_{Ms,V}^{1)}$	[-]	1,5			
Pull-out failure						
Characteristic resistance in cracked concrete	$N_{Rk,p,C1}$	[kN]	2,5	4	9	12
Concrete cone failure						
Effective embedment depth	h_{ef}	[mm]	30	42	46,4	54,9
Concrete cone failure	Edge distance	$c_{cr,N}$	1,5 h_{ef}			
	Spacing	$s_{cr,N}$	3 h_{ef}			
Installation factor	γ_{inst}	[-]	1,2		1,0	
Concrete pry-out failure						
Pry-out factor	k_8	[-]	1,0	1,5	2,0	
Concrete edge failure						
Effective length of fastener	$l_f = h_{ef}$	[mm]	30	42	46,4	54,9
Outside diameter of fastener	d_{nom}	[mm]	6		8	

¹⁾ In absence of other national regulations.

Knauf screw anchor KSA

Performances

Characteristic values under seismic loading, performance category C1 in concrete

Annex C3

Table C3: Characteristic values under seismic loading, performance category C2

Fastener size KSA			8	
			h_{nom3}	
Nominal embedment depth	h_{nom}	[mm]	70	
Adjustment				
Total max. thickness of adjustment layers	t_{adj}	[mm]	10	
Max. number of adjustments	n_a	[-]	2	
Steel failure for tension load				
Characteristic resistance	$N_{Rk,s,C2}$	[kN]	39,2	
Partial factor	$\gamma_{Ms,N}^{1)}$	[-]	1,4	
Pull out failure				
Characteristic resistance in cracked concrete	$N_{Rk,p,C2}$	[kN]	3,2	
Concrete cone failure				
Effective embedment depth	h_{ef}	[mm]	54,9	
Concrete cone failure	Edge distance	$c_{cr,N}$	[mm]	1,5 h_{ef}
	Spacing	$s_{cr,N}$	[mm]	3 h_{ef}
Installation factor	γ_{inst}	[-]	1,0	
Steel failure for shear load				
Installation with Hilti filling set				
Factor for annular gap	α_{gap}	[-]	1,0	
Characteristic resistance	$V_{Rk,s,C2}$	[kN]	14,7	
Partial factor	$\gamma_{Ms,V}^{1)}$	[-]	1,5	
Installation without Hilti filling set				
Factor for annular gap	α_{gap}	[-]	0,5	
Characteristic resistance	$V_{Rk,s,C2}$	[kN]	10,8	
Partial factor	$\gamma_{Ms,V}^{1)}$	[-]	1,5	
Concrete pry-out failure				
Pry-out factor	k_8	[-]	2,0	
Concrete edge failure				
Effective length of fastener	$l_f = h_{ef}$	[mm]	54,9	
Outside diameter of fastener	d_{nom}	[mm]	8	

¹⁾ In absence of other national regulations.

Knauf screw anchor KSA

Performances

Characteristic values under seismic loading, performance category C2 in concrete

Annex C4

Table C4: Characteristic values under fire exposure

Fastener KSA				6		8		
				h_{nom1}	h_{nom2}	h_{nom1}	h_{nom2}	h_{nom3}
Nominal embedment depth	h_{nom}	[mm]		40	55	50	60	70
Steel failure for tension and shear load ($F_{Rk,s,fi} = N_{Rk,s,fi} = V_{Rk,s,fi}$)								
Characteristic resistance	R30	$N_{Rk,s,fi}$	[kN]	0,5	1,6	3,2	3,5	3,8
	R60	$N_{Rk,s,fi}$	[kN]	0,5	1,2	2,4	2,6	2,8
	R90	$N_{Rk,s,fi}$	[kN]	0,5	0,8	1,6	1,6	1,9
	R120	$N_{Rk,s,fi}$	[kN]	0,4	0,7	1,2	1,2	1,5
	R30	$M^0_{Rk,s,fi}$	[Nm]	0,4	1,4	3,8	4,1	4,4
	R60	$M^0_{Rk,s,fi}$	[Nm]	0,4	1,1	2,8	3,0	3,4
	R90	$M^0_{Rk,s,fi}$	[Nm]	0,4	0,7	1,9	1,9	2,3
	R120	$M^0_{Rk,s,fi}$	[Nm]	0,3	0,6	1,5	1,4	1,7
Pull-out failure								
Characteristic resistance	R30 R60 R90	$N_{Rk,p,fi}$	[kN]	0,6	1,5	1,5	2,3	3,0
	R120	$N_{Rk,p,fi}$	[kN]	0,5	1,2	1,2	1,8	2,4
Concrete cone failure								
Characteristic resistance	R30 R60 R90	$N^0_{Rk,c,fi}$	[kN]	0,8	1,8	1,8	2,6	4,0
	R120	$N^0_{Rk,c,fi}$	[kN]	0,7	1,5	1,4	2,1	3,2
Edge distance								
R30 to R120 $c_{cr,fi}$ [mm]				2 h_{ef}				
In case of fire attack from more than one side, the minimum edge distance shall be ≥ 300 mm								
Fastener spacing								
R30 to R120 $s_{cr,fi}$ [mm]				2 $c_{cr,fi}$				
Concrete pry-out failure								
R30 to R120 k_8 [-]				1,0	1,5	1,0	2,0	
The anchorage depth shall be increased for wet concrete by at least 30 mm compared to the given value								

Knauf screw anchor KSA

Performances
Characteristic values under fire exposure in concrete

Annex C5

Table C5: Displacements under tension loads

Fastener size KSA				6		8		
				h_{nom1}	h_{nom2}	h_{nom1}	h_{nom2}	h_{nom3}
Nominal embedment depth [mm]				40	55	50	60	70
Cracked concrete C20/25 to C50/60	Tension Load	N	[kN]	1,0	2,4	4,3	5,7	7,6
	Displacement	δ_{N0}	[mm]	0,1	0,1	0,3	0,4	0,3
		$\delta_{N\infty}$	[mm]	0,6	0,6	0,7	0,7	0,6
Non-cracked concrete C20/25 to C50/60	Tension Load	N	[kN]	2,8	3,6	6,6	8,9	11,8
	Displacement	δ_{N0}	[mm]	0,2	0,2	0,1	0,2	0,1
		$\delta_{N\infty}$	[mm]	0,3		0,3		

Table C6: Displacements under shear loads

Fastener size KSA				6		8		
				h_{nom1}	h_{nom2}	h_{nom1}	h_{nom2}	h_{nom3}
Nominal embedment depth [mm]				40	55	50	60	70
Cracked concrete C20/25 to C50/60	Shear Load	V	[kN]	6,0		8,1		
	Displacement	δ_{V0}	[mm]	1,1	1,9	2,5	3,4	2,9
		$\delta_{V\infty}$	[mm]	2,0	2,8	3,7	5,1	4,4

Knauf screw anchor KSA

Performances

Displacement values in case of static and quasi-static loading

Annex C6

Table C7: Displacements under tension load for seismic performance category C2

Fastener size KSA	8
	h_{nom3}
Nominal embedment depth	70
Displacement DLS $\delta_{N,C2 (DLS)}$ [mm]	0,35
Displacement ULS $\delta_{N,C2 (ULS)}$ [mm]	0,65

Table C8: Displacements under shear load for seismic performance category C2

Fastener size KSA	8
	h_{nom3}
Nominal embedment depth	70
Installation with Hilti filling set	
Displacement DLS $\delta_{V,C2 (DLS)}$ [mm]	1,81
Displacement ULS $\delta_{V,C2 (ULS)}$ [mm]	4,60
Installation without Hilti filling set	
Displacement DLS $\delta_{V,C2 (DLS)}$ [mm]	3,93
Displacement ULS $\delta_{V,C2 (ULS)}$ [mm]	5,55

Knaf screw anchor KSA

Performances

Displacement values in case of seismic performance category C2

Annex C7