

Approval body for construction products
and types of construction

Bautechnisches Prüfamt

An institution established by the Federal and
Laender Governments



European Technical Assessment

ETA-20/0200
of 10 July 2020

English translation prepared by DIBt - Original version in German language

General Part

Technical Assessment Body issuing the
European Technical Assessment:

Deutsches Institut für Bautechnik

Trade name of the construction product

Chemofast Injection System EP 500
for rebar connection

Product family
to which the construction product belongs

Systems for post-installed rebar
connections with mortar

Manufacturer

CHEMOFAST Anchoring GmbH
Hanns-Martin-Schleyer-Straße 23
47877 Willich
DEUTSCHLAND

Manufacturing plant

CHEMOFAST Anchoring GmbH
Hanns-Martin-Schleyer-Straße 23
47877 Willich
DEUTSCHLAND

This European Technical Assessment
contains

19 pages including 3 annexes which form an integral part
of this assessment

This European Technical Assessment is
issued in accordance with Regulation (EU)
No 305/2011, on the basis of

EAD 330087-00-0601, Edition 05/2018

The European Technical Assessment is issued by the Technical Assessment Body in its official language. Translations of this European Technical Assessment in other languages shall fully correspond to the original issued document and shall be identified as such.

Communication of this European Technical Assessment, including transmission by electronic means, shall be in full. However, partial reproduction may only be made with the written consent of the issuing Technical Assessment Body. Any partial reproduction shall be identified as such.

This European Technical Assessment may be withdrawn by the issuing Technical Assessment Body, in particular pursuant to information by the Commission in accordance with Article 25(3) of Regulation (EU) No 305/2011.

Specific Part

1 Technical description of the product

The subject of this European Technical Assessment is the post-installed connection, by anchoring or overlap connection joint, of reinforcing bars (rebars) in existing structures made of normal weight concrete, using the "Chemofast Injection System EP 500 for rebar connection" in accordance with the regulations for reinforced concrete construction.

Reinforcing bars made of steel with a diameter ϕ from 8 to 40 according to Annex A and injection mortar EP 500 are used for rebar connections. The rebar is placed into a drilled hole filled with injection mortar and is anchored via the bond between rebar, injection mortar and concrete.

The product description is given in Annex A.

2 Specification of the intended use in accordance with the applicable European assessment Document

The performances given in Section 3 are only valid if the anchor is used in compliance with the specifications and conditions given in Annex B.

The verifications and assessment methods on which this European Technical Assessment is based lead to the assumption of a working life of the rebar connection of at least 50 years. The indications given on the working life cannot be interpreted as a guarantee given by the producer, but are to be regarded only as a means for choosing the right products in relation to the expected economically reasonable working life of the works.

3 Performance of the product and references to the methods used for its assessment

3.1 Mechanical resistance and stability (BWR 1)

Essential characteristic	Performance
Characteristic resistance under static and quasi-static loading	See Annex C 1

3.2 Safety in case of fire (BWR 2)

Essential characteristic	Performance
Reaction to fire	Class A1
Resistance to fire	See Annex C 2

4 Assessment and verification of constancy of performance (AVCP) system applied, with reference to its legal base

In accordance with European Assessment Document EAD No. 330087-00-0601, the applicable European legal act is: [96/582/EC].

The system(s) to be applied is (are): 1

5 Technical details necessary for the implementation of the AVCP system, as provided for in the applicable European Assessment Document

Technical details necessary for the implementation of the AVCP system are laid down in the control plan deposited with Deutsches Institut für Bautechnik.

Issued in Berlin on 10 July 2020 by Deutsches Institut für Bautechnik

Dr.-Ing. Lars Eckfeldt
p.p. Head of Department

beglaubigt:
Baderschneider

Installation post installed rebar

Figure A1: Overlapping joint for rebar connections of slabs and beams

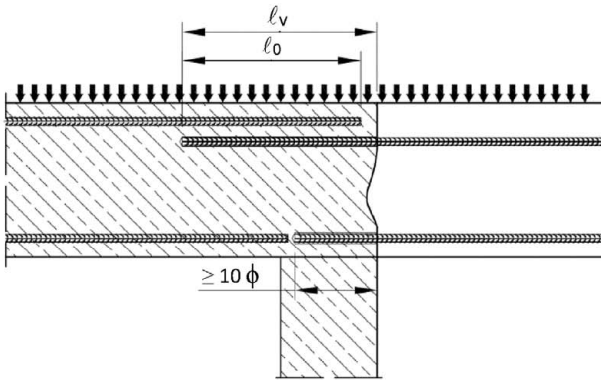

Figure A2: Overlapping joint at a foundation of a wall or column where the rebar are stressed in tension

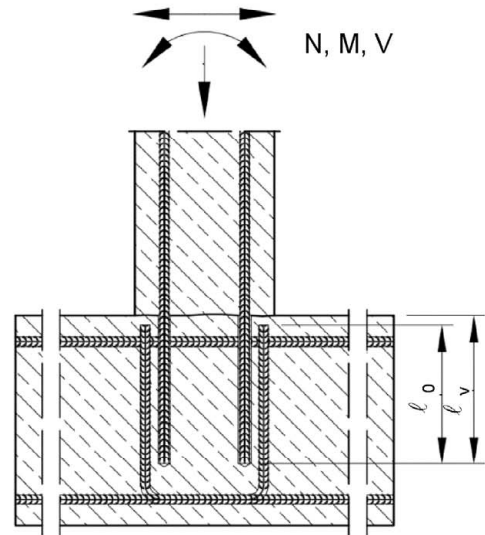

Figure A3: End anchoring of slabs or beams (e.g. designed as simply supported)

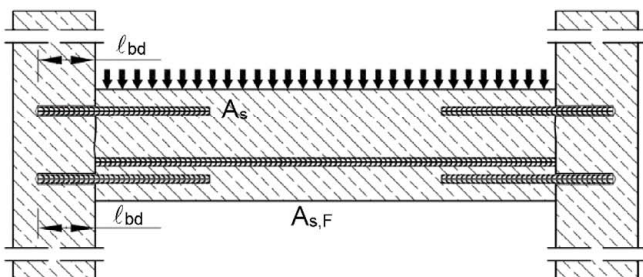

Figure A4: Rebar connection for components stressed primarily in compression. The rebar are stressed in compression

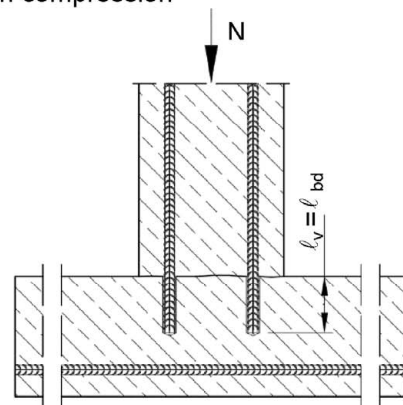
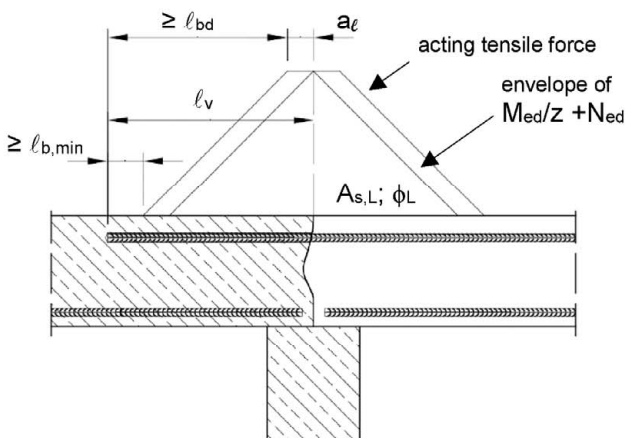

Figure A5: Anchoring of reinforcement to cover the line of acting tensile force



Note to Figure A1 to A5:

In the Figures no transverse reinforcement is plotted, the transverse reinforcement shall comply with EN 1992-1-1:2004+AC:2010.

Preparing of joints according to Annex B 2

Electronic copy of the ETA by DIBt: ETA-20/0200

Chemofast Injection System EP 500 for rebar connection

Product description
Installed condition and examples of use for rebars

Annex A 1

Chemofast Injection System EP 500:

Injection mortar: Chemofast EP 500

Type "side-by-side":
440ml, 585 ml and 1400 ml
cartridge

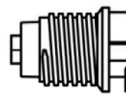

Imprint: Chemofast EP 500,
processing notes, charge-code, shelf life,
hazard-code, curing- and processing time
(depending on the temperature), Optional with
travel scale

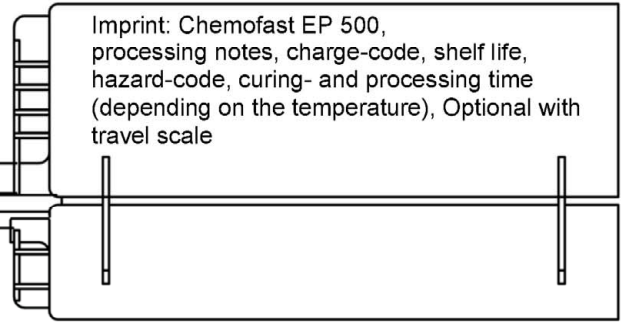

Static Mixer

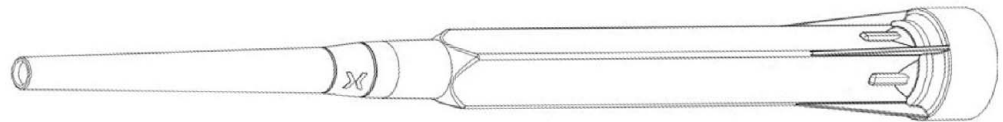

**Piston plug and mixer
extension**

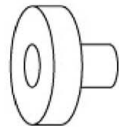

Reinforcing bar (rebar): ø8, ø10, ø12, ø14, ø16, ø20, ø22, ø24, ø25, ø28, ø32, ø34, ø36, ø40



Chemofast Injection System EP 500 for rebar connection

Product description
Injection mortar / Static mixer / Rebar

Annex A 2

Reinforcing bar (rebar): $\varnothing 8, \varnothing 10, \varnothing 12, \varnothing 14, \varnothing 16, \varnothing 20, \varnothing 22, \varnothing 24, \varnothing 25, \varnothing 28, \varnothing 32, \varnothing 34, \varnothing 36, \varnothing 40$

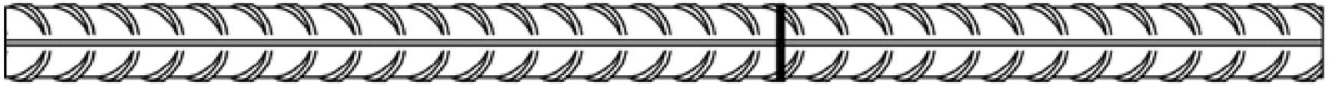

- Minimum value of related rip area $f_{R,min}$ according to EN 1992-1-1:2004+AC:2010
- Rib height of the bar shall be in the range $0,05\phi \leq h_{rib} \leq 0,07\phi$
(ϕ : Nominal diameter of the bar; h_{rib} : Rib height of the bar)

Table A1: Materials

Designation	Material
Rebar EN 1992-1-1:2004+AC:2010, Annex C	Bars and de-coiled rods class B or C f_{yk} and k according to NDP or NCL of EN 1992-1-1/NA $f_{uk} = f_{tk} = k \cdot f_{yk}$
Chemofast Injection System EP 500 for rebar connection	Annex A 3
Product description Materials Rebar	

Specifications of intended use

Anchorage subject to:

- Static and quasi-static loads.
- Fire exposure

Base materials:

- Reinforced or unreinforced normal weight concrete according to EN 206:2013 + A1:2016.
- Strength classes C12/15 to C50/60 according to EN 206:2013 + A1:2016.
- Maximum chloride content of 0,40% (CL 0.40) related to the cement content according to EN 206:2013 + A1:2016.
- Non-carbonated concrete.

Note: In case of a carbonated surface of the existing concrete structure the carbonated layer shall be removed in the area of the post-installed rebar connection with a diameter of $\phi + 60$ mm prior to the installation of the new rebar.

The depth of concrete to be removed shall correspond to at least the minimum concrete cover in accordance with EN 1992-1-1:2004+AC:2010.

The foregoing may be neglected if building components are new and not carbonated and if building components are in dry conditions.

Temperature Range:

- - 40°C to +80°C (max. short term temperature +80°C and max long term temperature +50°C).

Design:

- Anchorages are designed under the responsibility of an engineer experienced in anchorages and concrete work.
- Verifiable calculation notes and drawings are prepared taking account of the forces to be transmitted.
- Design according to EN 1992-1-1:2004+AC:2010, EN 1992-1-2:2004+AC:2008 and Annex B 2 and B 3.
- The actual position of the reinforcement in the existing structure shall be determined on the basis of the construction documentation and taken into account when designing.

Installation:

- Dry or wet concrete.
- It must not be installed in flooded holes.
- Hole drilling by hammer drill (HD), hollow drill (HDB), diamond drill (DD) or compressed air drill (CD).
- The installation of post-installed rebar resp. tension anchors shall be done only by suitable trained installer and under supervision on site; the conditions under which an installer may be considered as suitable trained and the conditions for supervision on site are up to the Member States in which the installation is done.
- Check the position of the existing rebars (if the position of existing rebars is not known, it shall be determined using a rebar detector suitable for this purpose as well as on the basis of the construction documentation and then marked on the building component for the overlap joint).

Chemofast Injection System EP 500 for rebar connection

**Intended use
Specifications**

Annex B 1

Figure B1: General construction rules for post-installed rebars

- Only tension forces in the axis of the rebar may be transmitted
- The transfer of shear forces between new concrete and existing structure shall be designed additionally according to EN 1992-1-1:2004+AC:2010.
- The joints for concreting must be roughened to at least such an extent that aggregate protrude.

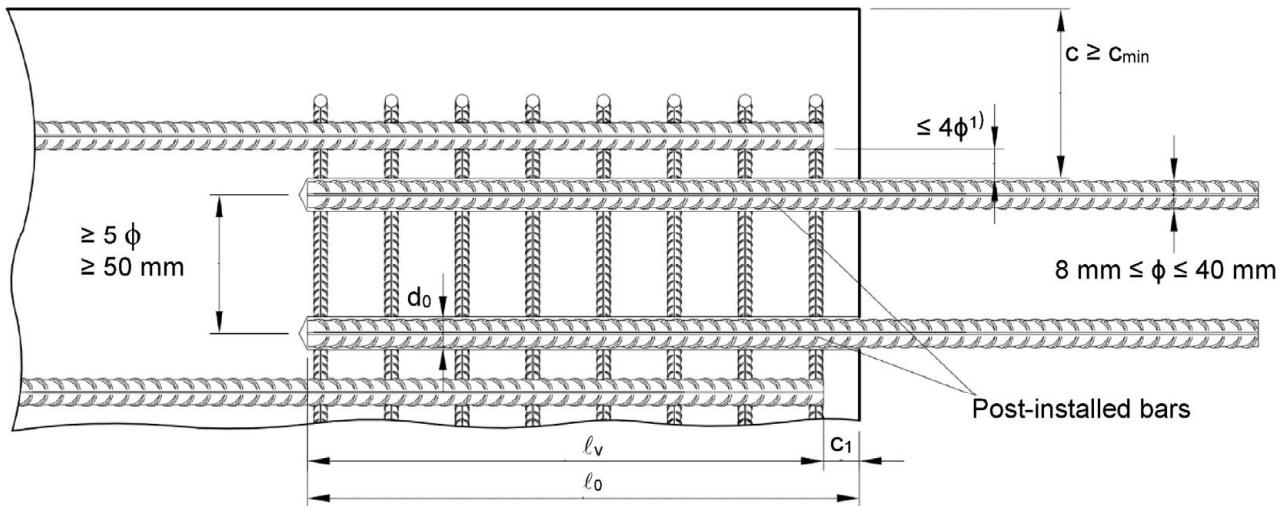

- 1) If the clear distance between lapped bars exceeds 4ϕ , then the lap length shall be increased by the difference between the clear bar distance and 4ϕ .

The following applies to Figure B1:

- c concrete cover of post-installed rebar
- c_1 concrete cover at end-face of existing rebar
- C_{\min} minimum concrete cover according to Table B1 and to EN 1992-1-1:2004+AC:2010, Section 4.4.1.2
- ϕ diameter of post-installed rebar
- l_0 lap length, according to EN 1992-1-1:2004+AC:2010, Section 8.7.3
- l_v effective embedment depth, $\geq l_0 + c_1$
- d_0 nominal drill bit diameter, see Annex B 5

Chemofast Injection System EP 500 for rebar connection

Intended use
General construction rules for post-installed rebars

Annex B 2

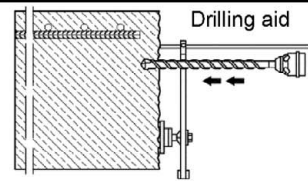

Table B1: Minimum concrete cover min $c^{1)}$ of post-installed rebar depending of drilling method

Drilling method	Rebar diameter	Without drilling aid	With drilling aid
Hammer drilling (HD) Hollow drilling (HDB)	< 25 mm	$30 \text{ mm} + 0,06 \cdot l_v \geq 2 \phi$	$30 \text{ mm} + 0,02 \cdot l_v \geq 2 \phi$
	$\geq 25 \text{ mm}$	$40 \text{ mm} + 0,06 \cdot l_v \geq 2 \phi$	$40 \text{ mm} + 0,02 \cdot l_v \geq 2 \phi$
Diamond drilling (DD)	< 25 mm	Drill rig used as drilling aid	$30 \text{ mm} + 0,02 \cdot l_v \geq 2 \phi$
	$\geq 25 \text{ mm}$		$40 \text{ mm} + 0,02 \cdot l_v \geq 2 \phi$
Compressed air drilling (CD)	< 25 mm	$50 \text{ mm} + 0,08 \cdot l_v$	$50 \text{ mm} + 0,02 \cdot l_v$
	$\geq 25 \text{ mm}$	$60 \text{ mm} + 0,08 \cdot l_v$	$60 \text{ mm} + 0,02 \cdot l_v$

¹⁾ see Annex B 2, Figure B1 and Annex B 3, Figure B2

Comments: The minimum concrete cover acc. EN 1992-1-1:2004+AC:2010 must be observed

Table B2: maximum embedment depth $l_{v,max}$





Rebar ϕ	HD / CD / DD $l_{v,max}$ [mm]	HDB $l_{v,max}$ [mm]
8 mm	800	800
10 mm	1000	1000
12 mm	1200	1000
14 mm	1400	1000
16 mm	1600	1000
20 mm	2000	1000
22 mm	2000	1000
24 mm	2000	1000
25 mm	2000	1000
28 mm	2000	1000
32 mm	2000	1000
34 mm	2000	-
36 mm	2000	-
40 mm	2000	-

Table B3: Base material temperature, gelling time and curing time

Concrete temperature	Gelling- / working time ¹⁾ t_{gel}	Minimum curing time in dry concrete $t_{cure,dry}$	Minimum curing time in wet concrete $t_{cure,wet}$
+ 5 °C to + 9 °C	80 min	60 h	120 h
+ 10 °C to + 14 °C	60 min	48 h	96 h
+ 15 °C to + 19 °C	40 min	24 h	48 h
+ 20 °C to + 24 °C	30 min	12 h	24 h
+ 25 °C to + 34 °C	12 min	10 h	20 h
+ 35 °C to + 39 °C	8 min	7 h	14 h
+40 °C	8 min	4 h	8 h
Cartridge temperature	+5°C to +40°C		

¹⁾ t_{gel} : maximum time from starting of mortar injection to completing of rebar setting.

Chemofast Injection System EP 500 for rebar connection	Annex B 3
Intended use Minimum concrete cover Maximum embedment depth	

Table B4: Dispensing tools			
Cartridge type/size	Hand tool		Pneumatic tool
Side-by-side cartridges 440, 585 ml	 e.g. SA 296C585	 e.g. Typ H 244 C	 e.g. Typ TS 444 KX
Side-by-side cartridges 1400 ml	-	-	 e.g. Typ TS 471

Ale cartridges can be used with battery tool as well.

Cleaning and installation tools

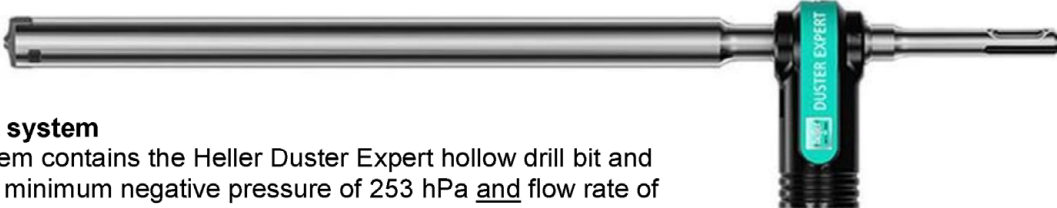

HDB – Hollow drill bit system
The hollow drill bit system contains the Heller Duster Expert hollow drill bit and a class M vacuum with minimum negative pressure of 253 hPa and flow rate of minimum 150 m³/h (42 l/s).

Brush RB: L d_b





SDS Plus Adapter:



Brush extension:

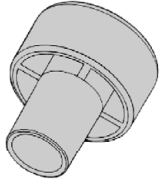

Piston Plug 

Hand pump (volume 750 ml) 

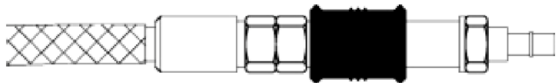
Rec. compressed air tool hand slide valve (min 6 bar) 

Chemofast Injection System EP 500 for rebar connection	Annex B 4
Intended Use Dispensing, cleaning and installation tools	

Table B5: Brushes, piston plugs, max anchorage depth and mixer extension, hammer (HD), diamond (DD) and compressed air (CD) drilling

Bar size ϕ	Drill bit - \emptyset			d_b Brush - \emptyset	$d_{b,min}$ min. Brush - \emptyset	Piston plug	Cartridge: 440 ml or 585 ml				Cartridge: 1400 ml				
	HD	DD	CD				Hand or battery tool		Pneumatic tool		Pneumatic tool				
							$l_{v,max}$	Mixer extension	$l_{v,max}$	Mixer extension	$l_{v,max}$	Mixer extension			
[mm]	[mm]			[mm]	[mm]		[mm]		[mm]		[mm]				
8	10	-	RB10	11,5	10,5	-	250	VL10/0,75 or VL16/1,8	250	VL10/0,75 or VL16/1,8	250	VL10/0,75 or VL16/1,8			
	12	-	RB12	13,5	12,5	-	700		800		800				
10	14	-	RB14	15,5	14,5	VS14	250		700		250		1300	250	1000
							700				1000			1000	
12	16		RB16	17,5	16,5	VS16	250		500		250		1000	250	2000
	18		RB18	20,0	18,5	VS18	700				1300			1200	
14	20		RB20	22,0	20,5	VS20	500		VL10/0,75 or VL16/1,8		1000		VL10/0,75 or VL16/1,8	1600	VL16/1,8
	20	25	-	RB25	27,0	25,5									
		-	26	RB26	28,0	26,5	VS25		500		1000		2000		
22	28		RB28	30,0	28,5	VS28	500							VL10/0,75 or VL16/1,8	1000
24/25	32		RB32	34,0	32,5	VS32		500	VL10/0,75 or VL16/1,8	1000	VL10/0,75 or VL16/1,8	2000	VL16/1,8		
28	35		RB35	37,0	35,5	VS35	500							VL10/0,75 or VL16/1,8	1000
32/34	40		RB40	43,5	40,5	VS40		500	VL10/0,75 or VL16/1,8	1000	VL10/0,75 or VL16/1,8	2000	VL16/1,8		
36	45		RB45	47,0	45,5	VS45	500							VL10/0,75 or VL16/1,8	1000
40	-	52	-	RB52	54,0	52,5		VS52	-	-	-	-	-		
		55	-	55	RB55	58,0	55,5	VS55	-	-	-	-	-		

Table B6: Brushes, piston plugs, max anchorage depth and mixer extension, hammer drilling with hollow drill bit system (HDB)

Bar size ϕ	Drill bit - \emptyset		d_b Brush - \emptyset	$d_{b,min}$ min. Brush - \emptyset	Piston plug	Cartridge: 440 ml or 585 ml				Cartridge: 1400 ml						
	HDB	HDB				Hand or battery tool		Pneumatic tool		Pneumatic tool						
						$l_{v,max}$	Mixer extension	$l_{v,max}$	Mixer extension	$l_{v,max}$	Mixer extension					
[mm]	[mm]						[mm]		[mm]		[mm]					
8	10		No cleaning Required			250	VL10/0,75 or VL16/1,8	250	VL10/0,75 or VL16/1,8	250	VL10/0,75 or VL16/1,8					
	12					-		700		800		800				
10	14					VS14		250		700		VL10/0,75 or VL16/1,8	250	1000	250	1000
	16							700					1000		1000	
12	18					VS16		500		VL10/0,75 or VL16/1,8		1000	1000	1000	1000	1000
	20					VS18										
14	25					VS20		500		VL10/0,75 or VL16/1,8		1000	1000	1000	1000	1000
	28					VS25										
20	32					VS28		500		VL10/0,75 or VL16/1,8		1000	1000	1000	1000	1000
	24/25					VS32										
28	35					VS35	500	VL10/0,75 or VL16/1,8	1000	1000	1000	1000	1000			
	32/34					VS40										

Chemofast Injection System EP 500 for rebar connection

Intended use
Installation tools

Annex B 5

A) Bore hole drilling

Note: Before drilling, remove carbonated concrete and clean contact areas (see Annex B1)

In case of aborted drill hole: the drill hole shall be filled with mortar.

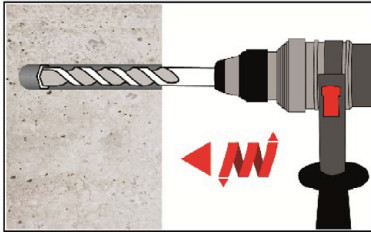

- 1a. Hammer (HD) or compressed air drilling (CD)**
Drill a hole into the base material to the size and embedment depth required by the selected reinforcing bar. Proceed with Step B1.

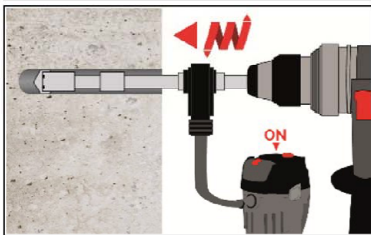

- 1b. Hollow drill bit system (HDB)** (see Annex B 4)
Drill a hole into the base material to the size and embedment depth required by the selected reinforcing bar. This drilling system removes the dust and cleans the bore hole during drilling.
Proceed with step C

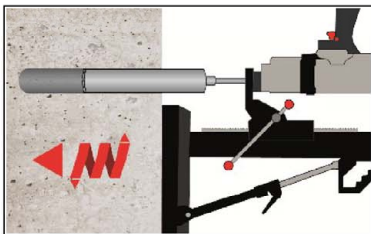

- 1c. Diamond drilling (DD)**
Drill with diamond drill a hole into the base material to the size and embedment depth required by the selected anchor.
Proceed with Step B2

Chemofast Injection System EP 500 for rebar connection

Intended use

Installation instruction: Bore hole drilling (HD, HDB and CD)

Annex B 6

B1) Bore hole cleaning

MAC: Cleaning for bore hole diameter $d_0 \leq 20\text{mm}$ and bore hole depth $h_0 \leq 10d_{\text{nom}}$ with drilling method HD/CD

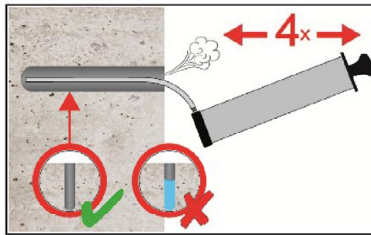

Attention! Standing water in the bore hole must be removed before cleaning.

2a. Starting from the bottom or back of the bore hole, blow the hole clean with handpump (Annex B 4) a minimum of four times until return air stream is free of noticeable dust.

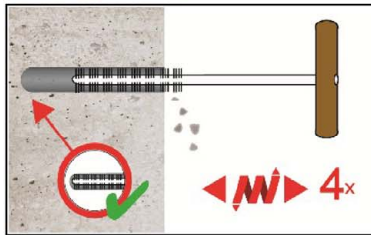

2b. Check brush diameter (Table B5). Brush the hole with an appropriate sized wire brush $> d_{b,\text{min}}$ (Table B5) a minimum of four times in a twisting motion. If the bore hole ground is not reached with the brush, a brush extension must be used.

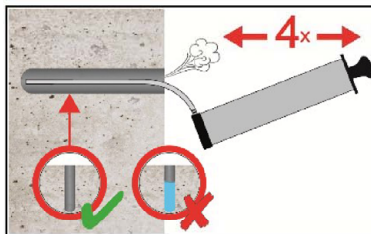

2c. Finally blow the hole clean again with handpump (Annex B 4) a minimum of four times until return air stream is free of noticeable dust.

CAC: Cleaning for all bore hole diameter and bore hole depth with drilling method HD and CD

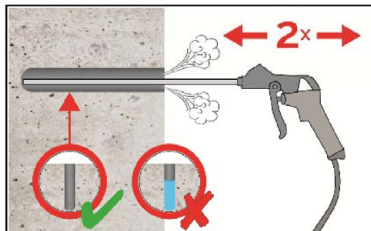

Attention! Standing water in the bore hole must be removed before cleaning.

2a. Starting from the bottom or back of the bore hole, blow the hole clean with compressed air (min. 6 bar) (Annex B 4) a minimum of two times until return air stream is free of noticeable dust. If the bore hole ground is not reached an extension shall be used

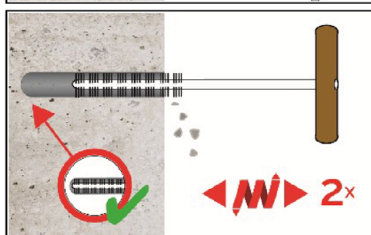

2b. Check brush diameter (Table B5). Brush the hole with an appropriate sized wire brush $> d_{b,\text{min}}$ (Table B5) a minimum of two times. If the bore hole ground is not reached with the brush, a brush extension shall be used (Table B5).

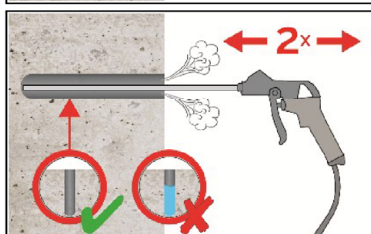

2c. Finally blow the hole clean again with compressed air (min. 6 bar) (Annex B 4) a minimum of two times until return air stream is free of noticeable dust. If the bore hole ground is not reached an extension shall be used.

After cleaning, the bore hole has to be protected against re-contamination in an appropriate way, until dispensing the mortar in the bore hole. If necessary, the cleaning has to be repeated directly before dispensing the mortar. In-flowing water must not contaminate the bore hole again.

Chemofast Injection System EP 500 for rebar connection

Intended use

Installation instruction: Bore hole cleaning (HD, HDB and CD)

Annex B 7

B2) Bore hole cleaning

SPCAC: Cleaning for all bore hole diameter and bore hole depth with drilling method DD

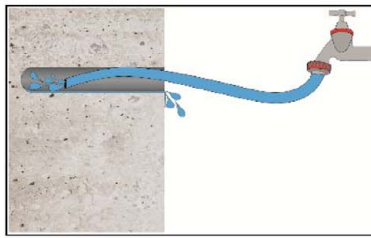

2a. Rinsing with water until clear water comes out.

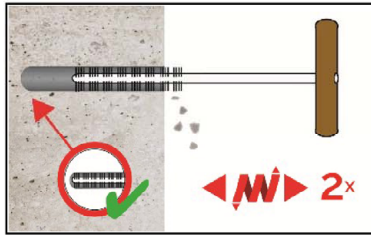

2b. Check brush diameter (Table B5). Brush the hole with an appropriate sized wire brush $> d_{b,min}$ (Table B5) a minimum of two times in a twisting motion. If the bore hole ground is not reached with the brush, a brush extension must be used.

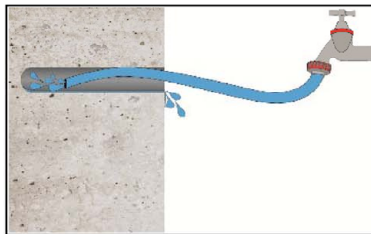

2c. Rinsing again with water until clear water comes out.

Attention! Standing water in the bore hole must be removed before cleaning.

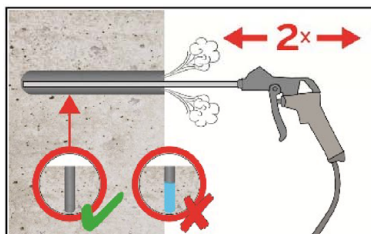

2d. Starting from the bottom or back of the bore hole, blow the hole clean with compressed air (min. 6 bar) (Annex B 4) a minimum of two times until return air stream is free of noticeable dust. If the bore hole ground is not reached an extension shall be used

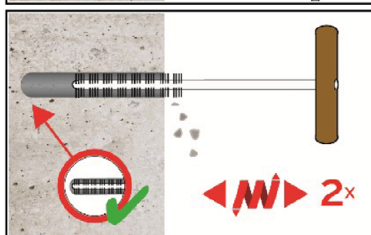

2e. Check brush diameter (Table B5). Brush the hole with an appropriate sized wire brush $> d_{b,min}$ (Table B5) a minimum of two times. If the bore hole ground is not reached with the brush, a brush extension shall be used (Table B5).

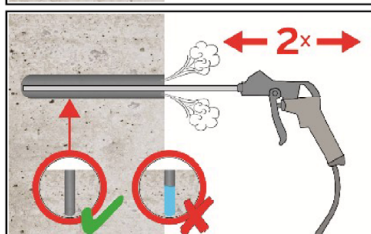

2f. Finally blow the hole clean again with compressed air (min. 6 bar) (Annex B 4) a minimum of two times until return air stream is free of noticeable dust. If the bore hole ground is not reached an extension shall be used.

After cleaning, the bore hole has to be protected against re-contamination in an appropriate way, until dispensing the mortar in the bore hole. If necessary, the cleaning has to be repeated directly before dispensing the mortar. In-flowing water must not contaminate the bore hole again.

Chemofast Injection System EP 500 for rebar connection

Intended use
Installation instruction: Bore hole cleaning

Annex B 8

C) Preparation of bar and cartridge

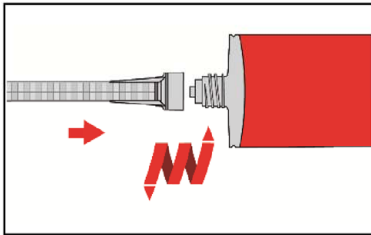

3. Attach the supplied static-mixing nozzle to the cartridge and load the cartridge into the correct dispensing tool.
For every working interruption longer than the recommended working time (Table B3) as well as for every new cartridges, a new static-mixer shall be used

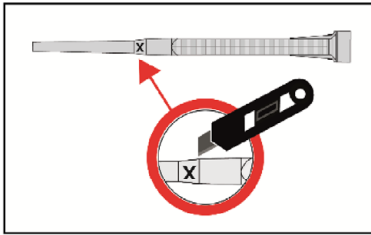

- 3a. In case of using the mixer extension VL16/1,8, the tip of the mixer nozzle has to be cut off at position „X“.

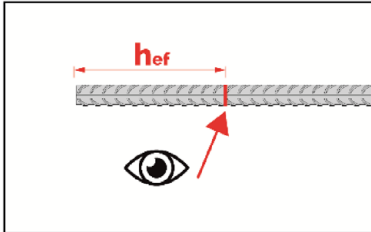

4. Prior to inserting the reinforcing bar into the filled bore hole, the position of the embedment depth shall be marked (e.g. with tape) on the reinforcing bar and insert bar in empty hole to verify hole and depth l_v .
The anchor should be free of dirt, grease, oil or other foreign material.

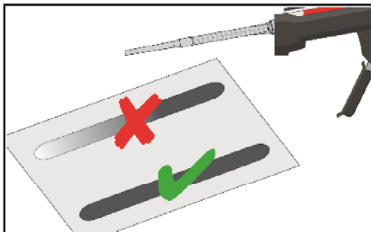

5. Prior to dispensing into the bore hole, squeeze out separately the mortar until it shows a consistent grey or red colour, but a minimum of three full strokes, and discard non-uniformly mixed adhesive components

D) Filling the bore hole

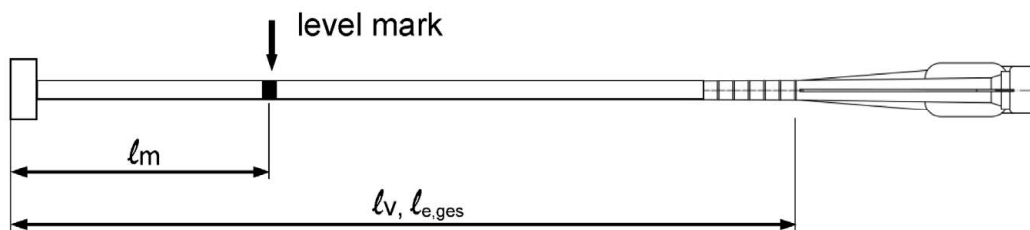

Injection tool must be marked by mortar level mark l_m and anchorage depth l_v resp. $l_{e,ges}$ with tape or marker.

Quick estimation: $l_m = 1/3 \cdot l_v$

Continue injection until the mortar level mark l_m becomes visible.

Optimum mortar volume:

$$l_m = l_v \text{ resp. } l_{e,ges} \cdot \left(1,2 \cdot \frac{\phi^2}{d_0^2} - 0,2 \right)$$

Chemofast Injection System EP 500 for rebar connection

Intended Use

Installation instruction: Preparation of bar and cartridge
Filling the bore hole

Annex B 9

	<p>6a. Starting from the bottom or back of the cleaned bore hole fill the hole with adhesive, until the level mark at the mixer extension (see below) is visible at the top of the hole. If the bottom or back of the anchor hole is not reached, an appropriate extension nozzle must be used. Slowly withdraw the static mixing nozzle and using a piston plugs during injection of the mortar, helps to avoid creating air pockets. Observe the gel-/ working times given in Table B3.</p>
	<p>6b. Piston plugs shall be used according to Table B4 for the following applications:</p> <ul style="list-style-type: none"> - For overhead and horizontal installation - In vertical downwards direction with bore holes deeper than 240 mm <p>Assemble mixing nozzle, mixer extension and piston plug before injecting mortar.</p>
	<p>6c. Insert piston plug to back of the hole and inject adhesive. If the bottom or back of the anchor hole is not reached, an appropriate extension nozzle must be used. During injection the piston plug will be naturally extruded out of the drill hole by the adhesive pressure. Observe the gel-/ working times given in Table B3.</p>
<p>E) Setting the rebar</p>	
	<p>7. Push the reinforcing bar into the bore hole while turning slightly to ensure positive distribution of the adhesive until the embedment depth is reached.</p> <p>The bar should be free of dirt, grease, oil or other foreign material.</p>
	<p>8. Be sure that the bar is inserted in the bore hole until the embedment mark is at the concrete surface and that excess mortar is visible at the top of the hole. If these requirements are not maintained, the application has to be renewed.</p>
	<p>8a. For horizontal and overhead installation fix embedded part (e.g. with wedges) until the mortar has started to harden.</p>
	<p>9. Observe gelling time t_{gel}. Attend that the gelling time can vary according to the base material temperature (see Table B3). Do not move or load the bar until full curing time t_{cure} has elapsed (attend Table B3).</p>

Minimum anchorage length and minimum lap length

The minimum anchorage length $\ell_{b,min}$ and the minimum lap length $\ell_{0,min}$ according to EN 1992-1-1:2004+AC:2010 ($\ell_{b,min}$ acc. to Eq. 8.6 and Eq. 8.7 and $\ell_{0,min}$ acc. to Eq. 8.11) shall be multiply by the amplification factor α_{lb} according to Table C1.

Table C1: Amplification factor α_{lb} related to concrete class

Concrete class	Drilling method	Bar size	Amplification factor α_{lb}
C12/15 to C50/60	HD: hammer drilling HDB: hollow drilling CD: compressed air drilling	8 mm to 40 mm	1,0
C12/15 to C50/60	DD: diamond drilling	8 mm to 40 mm	1,5

Table C2: Reduction factor k_b

Rebar ϕ	Drilling method	Concrete class								
		C12/15	C16/20	C20/25	C25/30	C30/37	C35/45	C40/50	C45/55	C50/60
8 to 40 mm	HD, HDB, CD	1,0								
8 to 40 mm	DD	1,0			0,90	0,79	0,73	0,68	0,63	

Table C3: Design values of the ultimate bond stress $f_{bd,PIR}$ in N/mm² for good conditions

$$f_{bd,PIR} = k_b \cdot f_{bd}$$

with

f_{bd} : Design value of the ultimate bond stress in N/mm² considering the concrete classes, the rebar diameter, the drilling method according to EN 1992-1-1:2004+AC:2010.

(for all other bond conditions multiply the values by 0.7)

k_b : Reduction factor according to Table C2

Rebar ϕ	Drilling method	Concrete class								
		C12/15	C16/20	C20/25	C25/30	C30/37	C35/45	C40/50	C45/55	C50/60
8 to 32 mm	HD, HDB, CD	1,6	2,0	2,3	2,7	3,0	3,4	3,7	4,0	4,3
34 mm		1,6	2,0	2,3	2,6	2,9	3,3	3,6	3,9	4,2
36 mm		1,5	1,9	2,2	2,6	2,9	3,3	3,6	3,8	4,1
40 mm		1,5	1,8	2,1	2,5	2,8	3,1	3,4	3,7	4,0
8 to 32 mm	DD	1,6	2,0	2,3	2,7					
34 mm		1,6	2,0	2,3	2,6					
36 mm		1,5	1,9	2,2	2,6					
40 mm		1,5	1,8	2,1	2,5					

Chemofast Injection System EP 500 for rebar connection

Performances

Amplification factor α_{lb} , Reduction factor k_b

Design values of ultimate bond resistance $f_{bd,PIR}$

Annex C 1

Design value of the ultimate bond stress $f_{bd,fi}$ under fire exposure for concrete classes C12/15 to C50/60, (all drilling methods):

The design value of the bond strength $f_{bd,fi}$ under fire exposure has to be calculated by the following equation:

$$f_{bd,fi} = k_{fi}(\theta) \cdot f_{bd,PIR} \cdot \gamma_c / \gamma_{M,fi}$$

with: $\theta \leq 140^\circ\text{C}$: $k_{fi}(\theta) = 5862 \cdot \theta^{-1,657} / (f_{bd,PIR} \cdot 4,3) \leq 1,0$
 $\theta > 140^\circ\text{C}$: $k_{fi}(\theta) = 0$

$f_{bd,fi}$ Design value of the ultimate bond stress in case of fire in N/mm²

θ Temperature in °C in the mortar layer.

$k_{fi}(\theta)$ Reduction factor under fire exposure.

$f_{bd,PIR}$ Design value of the ultimate bond stress in N/mm² in cold condition according to Table C3 considering the concrete classes, the rebar diameter, the drilling method and the bond conditions according to EN 1992-1-1:2004+AC:2010.

γ_c partially safety factor according to EN 1992-1-1:2004+AC:2010

$\gamma_{M,fi}$ partially safety factor according to EN 1992-1-2:2004+AC:2008

For evidence under fire exposure the anchorage length shall be calculated according to EN 1992-1-1:2004+AC:2010 Equation 8.3 using the temperature-dependent ultimate bond stress $f_{bd,fi}$.

Example graph of Reduction factor $k_{fi}(\theta)$ for concrete classes C20/25 for good bond conditions:

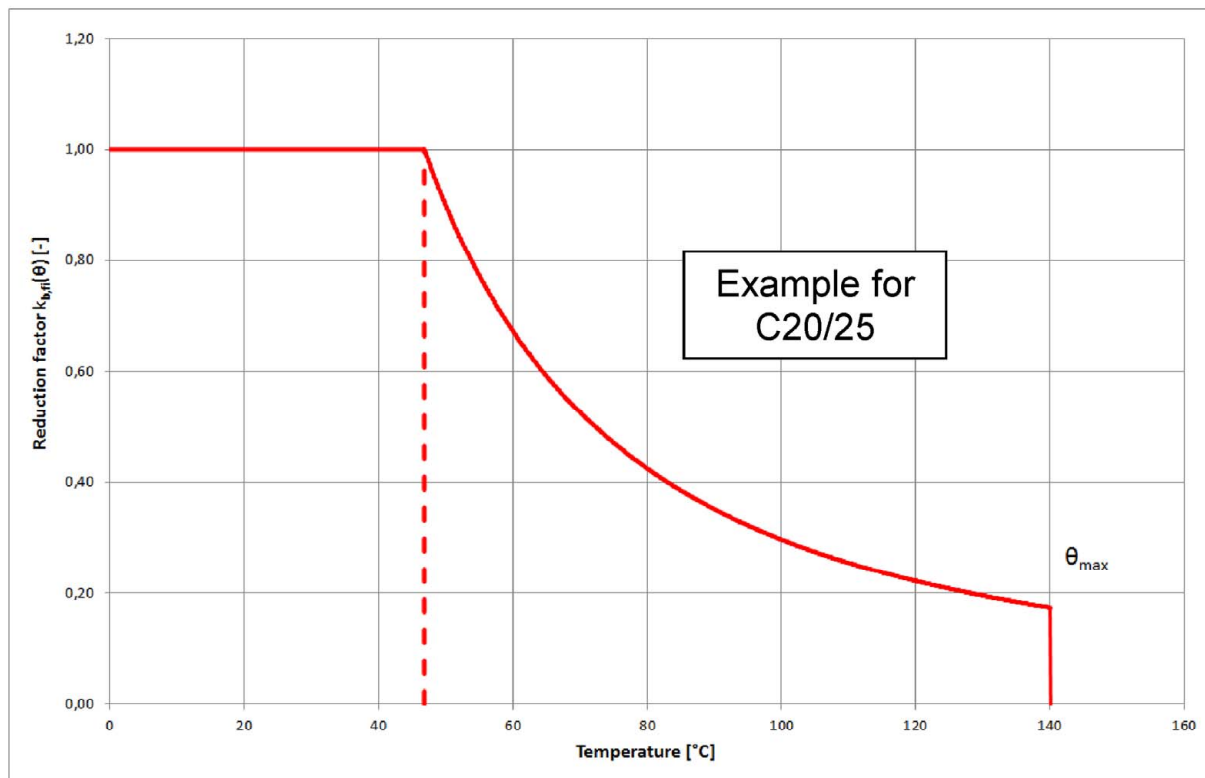

Chemofast Injection System EP 500 for rebar connection

Performances

Design value of bond strength $f_{bd,fi}$ under fire exposure

Annex C 2