

Approval body for construction products
and types of construction

Bautechnisches Prüfamt

An institution established by the Federal and
Laender Governments



European Technical Assessment

ETA-20/0557
of 23 September 2020

English translation prepared by DIBt - Original version in German language

General Part

Technical Assessment Body issuing the
European Technical Assessment:

Deutsches Institut für Bautechnik

Trade name of the construction product

Chemofast Injection system STVK Pro
or STVK NORDIC Pro

Product family
to which the construction product belongs

Metal Injection anchors for use in masonry

Manufacturer

CHEMOFAST Anchoring GmbH
Hanns-Martin-Schleyer-Straße 23
47877 Willich
DEUTSCHLAND

Manufacturing plant

CHEMOFAST Anchoring GmbH
Hanns-Martin-Schleyer-Straße 23
47877 Willich
DEUTSCHLAND

This European Technical Assessment
contains

66 pages including 3 annexes which form an integral part
of this assessment

This European Technical Assessment is
issued in accordance with Regulation (EU)
No 305/2011, on the basis of

EAD 330076-00-0604, Edition 11/2017

The European Technical Assessment is issued by the Technical Assessment Body in its official language. Translations of this European Technical Assessment in other languages shall fully correspond to the original issued document and shall be identified as such.

Communication of this European Technical Assessment, including transmission by electronic means, shall be in full. However, partial reproduction may only be made with the written consent of the issuing Technical Assessment Body. Any partial reproduction shall be identified as such.

This European Technical Assessment may be withdrawn by the issuing Technical Assessment Body, in particular pursuant to information by the Commission in accordance with Article 25(3) of Regulation (EU) No 305/2011.

Specific Part

1 Technical description of the product

The Chemofast Injection System STVK Pro or STVK NORDIC Pro is a bonded anchor (injection type) consisting of a mortar cartridge with injection mortar STVK Pro or STVK NORDIC Pro, a perforated sleeve and an anchor rod with hexagon nut and washer or an Internal threaded rod. The steel elements are made of zinc coated steel, stainless steel or high corrosion resistant steel.

The anchor rod is placed into a drilled hole filled with injection mortar and is anchored via the bond between steel element, injection mortar and masonry and mechanical interlock.

The product description is given in Annex A.

2 Specification of the intended use in accordance with the applicable European Assessment Document

The performances given in Section 3 are only valid if the anchor is used in compliance with the specifications and conditions given in Annex B.

The verifications and assessment methods on which this European Technical Assessment is based lead to the assumption of a working life of the anchor of at least 50 years. The indications given on the working life cannot be interpreted as a guarantee given by the producer, but are to be regarded only as a means for choosing the right products in relation to the expected economically reasonable working life of the works.

3 Performance of the product and references to the methods used for its assessment

3.1 Mechanical resistance and stability (BWR 1)

Essential characteristic	Performance
Characteristic values for resistance	See Annexes C 1 to C 48
Displacements	See Annex C 6 to C 48
Durability	See annex B 1

3.2 Safety in case of fire (BWR 2)

Essential characteristic	Performance
Reaction to fire	Class A1

3.3 Hygiene, health and the environment (BWR 3)

Essential characteristic	Performance
Content, emission and/or release of dangerous substances	No performance assessed

4 Assessment and verification of constancy of performance (AVCP) system applied, with reference to its legal base

In accordance with the European Assessment Document EAD 330076-00-0604 the applicable European legal act is: [97/177/EC].

The system to be applied is: 1

5 Technical details necessary for the implementation of the AVCP system, as provided for in the applicable European Assessment Document

Technical details necessary for the implementation of the AVCP system are laid down in the control plan deposited at Deutsches Institut für Bautechnik.

Issued in Berlin on 23 September 2020 by Deutsches Institut für Bautechnik

BD Dipl.-Ing. Andreas Kummerow
Head of Department

beglaubigt.
Baderschneider

Installation in hollow brick; threaded rod and Internal threaded rod with sleeve

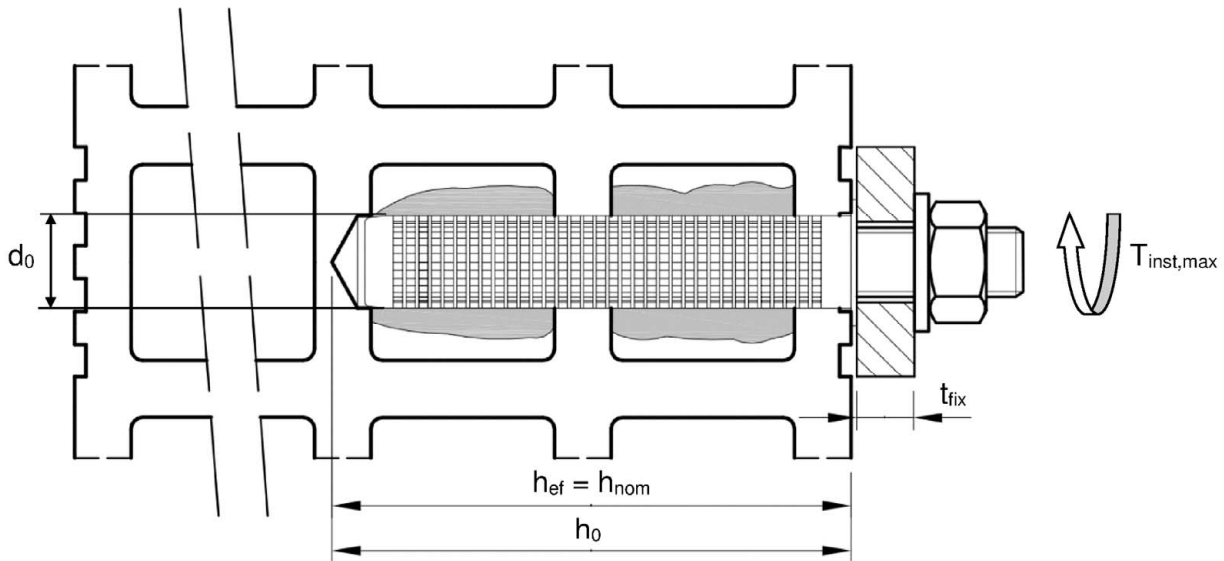

Installation in solid brick; threaded rod and Internal threaded rod with or without sleeve

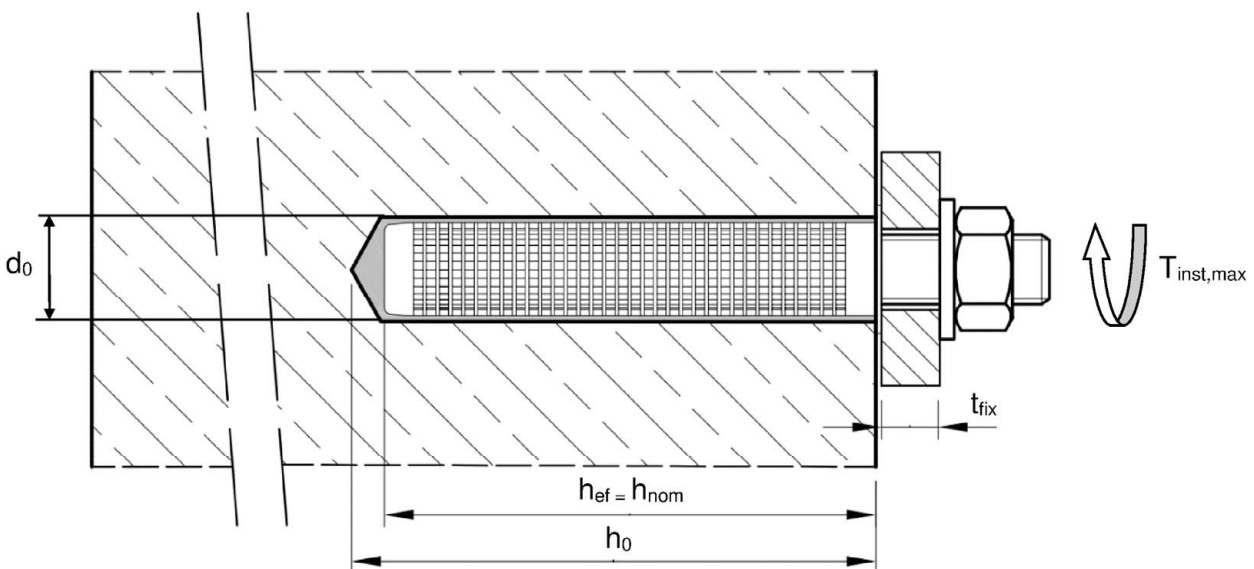

$h_{ef} = h_{nom}$ = effective anchorage depth

d_0 = nominal drill hole diameter

h_0 = drill hole depth

$T_{inst,max}$ = Max installation torque moment

t_{fix} = thickness of fixture

Chemofast Injection System STVK Pro or STVK NORDIC Pro

Product description
Installed condition

Annex A 1

Cartridge: Chemofast STVK or Chemofast STVK Nordic

150 ml, 280 ml, 300 ml up to 333 ml and 380 ml up to 420 ml Cartridge: (Type: coaxial)

Sealing/Screw cap

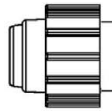

Imprint: Chemofast STVK or Chemofast STVK Nordic, processing notes, charge-code, shelf life, storage temperature, hazard-code, curing- and processing time (depending on the temperature), with as well as without travel scale

235 ml, 345 ml up to 360 ml and 825 ml Cartridge (Type: "side-by-side")

Sealing/Screw cap

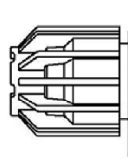

Imprint: Chemofast STVK or Chemofast STVK Nordic, processing notes, charge-code, shelf life, storage temperature, hazard-code, curing- and processing time (depending on the temperature), with as well as without travel scale

165 ml and 300 ml Cartridge (Type: "foil tube")

Sealing/Screw cap

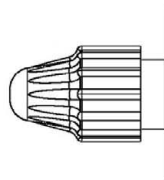

Imprint: Chemofast STVK or Chemofast STVK Nordic, processing notes, charge-code, shelf life, storage temperature, hazard-code, curing- and processing time (depending on the temperature), with as well as without travel scale

Static mixer

CRW 14W

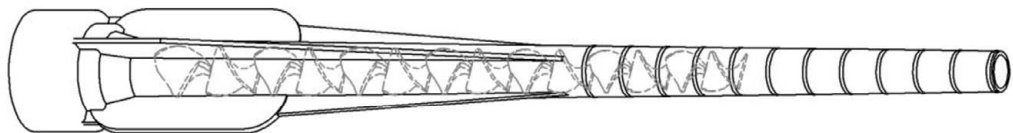

Chemofast Injection System STVK Pro or STVK NORDIC Pro

Product description
Injection system

Annex A 2

Threaded Rod M8, M10, M12, M16

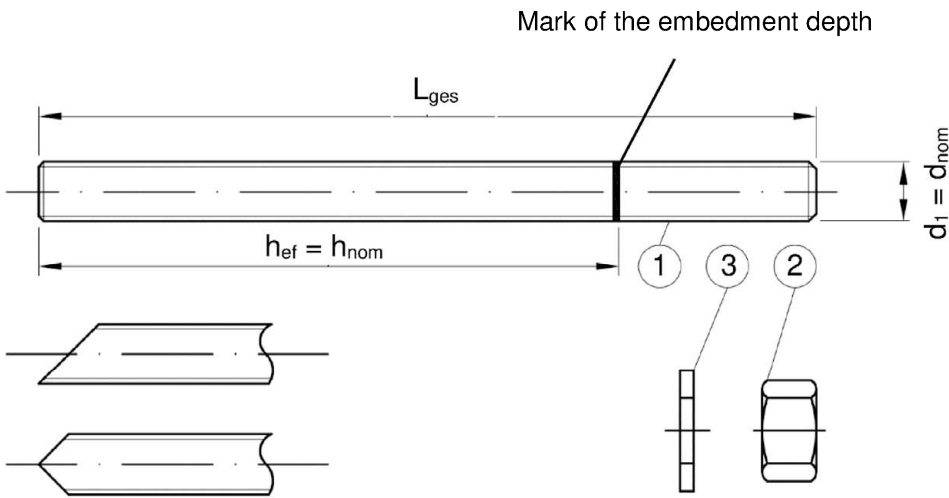



Commercial standard rod with:

- Materials, dimensions and mechanical properties acc. to Table A1
- Inspection certificate 3.1 acc. to EN 10204:2004. The document shall be stored.
- Marking of embedment depth

Internal threaded rod IG-M6, IG-M8, IG-M10

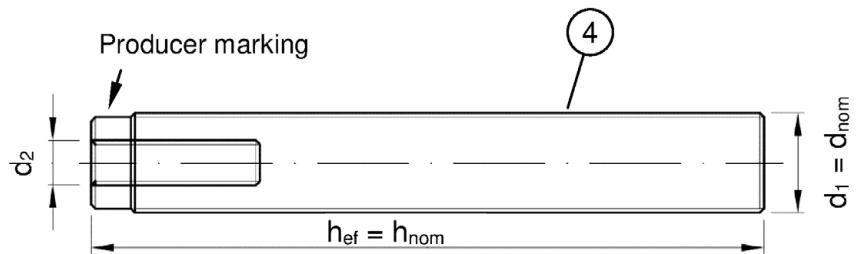
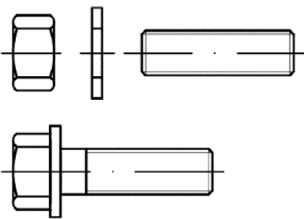
Threaded rod or screw



Producer marking: e.g.  M8

 Marking Internal thread

 Mark

M8 Thread size (Internal thread)

A4 additional mark for stainless steel

HCR additional mark for high-corrosion resistance steel

Chemofast Injection System STVK Pro or STVK NORDIC Pro

Product description
Anchor rods

Annex A 3

Table A1: Materials					
Part	Designation	Material			
Steel, zinc plated (Steel acc. to EN 10087:1998 or EN 10263:2001)					
- zinc plated $\geq 5 \mu\text{m}$ acc. to EN ISO 4042:1999 or					
- hot-dip galvanised $\geq 40 \mu\text{m}$ acc. to EN ISO 1461:2009 and EN ISO 10684:2004+AC:2009 or					
- sherardized $\geq 45 \mu\text{m}$ acc. to EN ISO 17668:2016					
1	Threaded rod	Property class	Characteristic steel ultimate tensile strength	Characteristic steel yield strength	
		acc. to EN ISO 898-1:2013	4.6	$f_{uk} = 400 \text{ N/mm}^2$	$f_{yk} = 240 \text{ N/mm}^2$
			4.8	$f_{uk} = 400 \text{ N/mm}^2$	$f_{yk} = 320 \text{ N/mm}^2$
			5.6	$f_{uk} = 500 \text{ N/mm}^2$	$f_{yk} = 300 \text{ N/mm}^2$
			5.8	$f_{uk} = 500 \text{ N/mm}^2$	$f_{yk} = 400 \text{ N/mm}^2$
8.8	$f_{uk} = 800 \text{ N/mm}^2$	$f_{yk} = 640 \text{ N/mm}^2$			
2	Hexagon nut	acc. to EN ISO 898-2:2012	4	for anchor rod class 4.6 or 4.8	
			5	for anchor rod class 5.6 or 5.8	
			8	for anchor rod class 8.8	
3	Washer	Steel, zinc plated, hot-dip galvanised or sherardized (e.g.: EN ISO 887:2006, EN ISO 7089:2000, EN ISO 7093:2000 or EN ISO 7094:2000)			
4	Internal threaded anchor rod	Property class	Characteristic steel ultimate tensile strength	Characteristic steel yield strength	
		acc. to EN ISO 898-1:2013	5.8	$f_{uk} = 500 \text{ N/mm}^2$	$f_{yk} = 400 \text{ N/mm}^2$
			8.8	$f_{uk} = 800 \text{ N/mm}^2$	$f_{yk} = 640 \text{ N/mm}^2$
Stainless steel A2 (Material 1.4301 / 1.4307 / 1.4311 / 1.4567 or 1.4541, acc. to EN 10088-1:2014)					
Stainless steel A4 (Material 1.4401 / 1.4404 / 1.4571 / 1.4362 or 1.4578, acc. to EN 10088-1:2014)					
High corrosion resistance steel (Material 1.4529 or 1.4565, acc. to EN 10088-1: 2014)					
1	Threaded rod ¹⁾	Property class	Characteristic steel ultimate tensile strength	Characteristic steel yield strength	
		acc. to EN ISO 3506-1:2009	50	$f_{uk} = 500 \text{ N/mm}^2$	$f_{yk} = 210 \text{ N/mm}^2$
			70	$f_{uk} = 700 \text{ N/mm}^2$	$f_{yk} = 450 \text{ N/mm}^2$
80	$f_{uk} = 800 \text{ N/mm}^2$	$f_{yk} = 600 \text{ N/mm}^2$			
2	Hexagon nut ¹⁾	acc. to EN ISO 3506-1:2009	50	for anchor rod class 50	
			70	for anchor rod class 70	
			80	for anchor rod class 80	
3	Washer	A2: Material 1.4301 / 1.4307 / 1.4311 / 1.4567 or 1.4541, acc. to EN 10088-1:2014 A4: Material 1.4401 / 1.4404 / 1.4571 / 1.4362 or 1.4578, acc. to EN 10088-1:2014 HCR: Material 1.4529 or 1.4565, acc. to EN 10088-1: 2014 (e.g.: EN ISO 887:2006, EN ISO 7089:2000, EN ISO 7093:2000 or EN ISO 7094:2000)			
4	Internal threaded anchor rod ¹⁾	Property class	Characteristic steel ultimate tensile strength	Characteristic steel yield strength	
		acc. to EN ISO 3506-1:2009	50	$f_{uk} = 500 \text{ N/mm}^2$	$f_{yk} = 210 \text{ N/mm}^2$
			70	$f_{uk} = 700 \text{ N/mm}^2$	$f_{yk} = 450 \text{ N/mm}^2$
¹⁾ Property class 80 only for stainless steel A4 and HCR					
Plastic sleeve					
Perforated sleeve			Polypropylene (PP)		
Chemofast Injection System STVK Pro or STVK NORDIC Pro				Annex A 4	
Product description Materials					

Table A2: perforated sleeve

<p>SH 12x80 SH 16x85 SH 20x85</p> 	<p>SH 16x130 / 330</p> <p>for installation through insulation up to a thickness of 20 cm or push through installation</p> 	
---	--	--

Table A3: sleeve dimensions

sleeve			
size	d_s	L_s	$h_{ef} = h_{nom}$
[mm]	[mm]	[mm]	[mm]
SH 12x80	12	80	80
SH 16x85	16	85	85
SH 16x130	16	130	130
SH 16x130 / 330 ¹⁾	16	330	130
SH 20x85	20	85	85
SH 20x130	20	130	130
SH 20x200	20	200	200

¹⁾ In annex C4 – C48 this sleeve is covered with the SH 16x130

Table A4: Steel parts

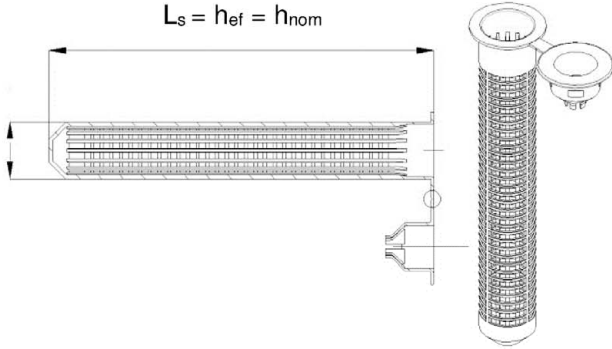
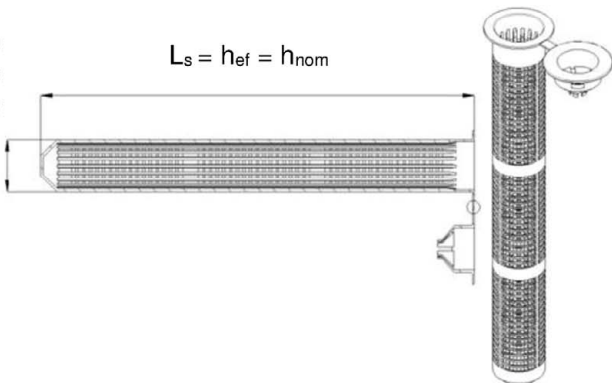
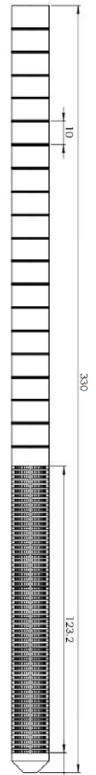
Anchor Rod			
Size	$d_1 = d_{nom}$	d_2	l_{ges}
[mm]	[mm]	[mm]	[mm]
IG-M6 ¹⁾	10	6	with sleeve: hef - 5mm without sleeve: hef
IG-M8 ¹⁾	12	8	
IG-M10 ¹⁾	16	10	
M8	8	-	hef + t _{fix} + 9,5
M10	10	-	hef + t _{fix} + 11,5
M12	12	-	hef + t _{fix} + 17,5
M16	16	-	hef + t _{fix} + 20,0

¹⁾ Internal threaded rod with metric external thread

Chemofast Injection System STVK Pro or STVK NORDIC Pro

Product description
Sleeves

Annex A 5

Specifications of intended use

Anchorage subject to:

- Static and quasi-static loads

Base materials:

- Autoclaved Aerated Concrete (Use condition d) according to Annex B2
- Solid brick masonry (Use condition b), according to Annex B2.
- Hollow brick masonry (Use condition c), according to Annex B2 and B3
- Mortar strength class of the masonry M2,5 at minimum according to EN 998-2:2010.
- For other bricks in solid masonry and in hollow masonry or in autoclaved aerated concrete, the characteristic resistance of the anchor may be determined by job site tests according to EOTA TR 053, Edition April 2016 under consideration of the β -factor according to Annex C1, Table C1.

Temperature Range:

- T_a : - 40°C to +40°C (max. short term temperature +40°C and max. long term temperature +24°C)
- T_b : - 40°C to +80°C (max. short term temperature +80°C and max. long term temperature +50°C)
- T_c : - 40°C to +120°C (max. short term temperature +120°C and max. long term temperature +72°C)

Use conditions (Environmental conditions):

- Dry and wet structure (regarding injection mortar).
- Structures subject to dry internal conditions (zinc coated steel, stainless steel or high corrosion resistant steel).
- Structures subject to external atmospheric exposure (including industrial and marine environment) and to permanently damp internal condition, if no particular aggressive conditions exist (stainless steel or high corrosion resistant steel).
- Structures subject to external atmospheric exposure and to permanently damp internal condition, if other particular aggressive conditions exist (high corrosion resistant steel).

Note: Particular aggressive conditions are e.g. permanent, alternating immersion in seawater or the splash zone of seawater, chloride atmosphere of indoor swimming pools or atmosphere with extreme chemical pollution (e.g. in desulphurization plants or road tunnels where de-icing materials are used).

Use conditions in respect of installation and use:

- Condition d/d: Installation and use in dry masonry
- Condition w/w: Installation and use in dry or wet masonry (incl. w/d installation in wet masonry and use in dry masonry)

Design:

- Verifiable calculation notes and drawings are prepared taking account the relevant masonry in the region of the anchorage, the loads to be transmitted and their transmission to the supports of the structure. The position of the anchor is indicated on the design drawings.
- The anchorages are designed in accordance with the EOTA TR 054, Edition April 2016, Design method A under the responsibility of an engineer experienced in anchorages and masonry work.
- $N_{RK,p} = N_{RK,b}$ see Annex C4 to C48; $N_{RK,s}$ see Annex C2; $N_{RK,pb}$ see EOTA TR 054, Edition April 2016
- $V_{RK,b}$ see Annex C4 to C48; $V_{RK,s}$ see Annex C2; $V_{RK,c}$ see Annex C3; $V_{RK,pb}$ see EOTA TR 054, Edition April 2016
- For application with sleeve with drill bit size ≤ 15 mm installed in joints not filled with mortar:
 - $N_{RK,p,j} = 0,18 * N_{RK,p}$ and $N_{RK,b,j} = 0,18 * N_{RK,b}$ ($N_{RK,p} = N_{RK,b}$ see Annex C4 to C48)
 - $V_{RK,c,j} = 0,15 * V_{RK,c}$ and $V_{RK,b,j} = 0,15 * V_{RK,b}$ ($V_{RK,b}$ see Annex C4 to C48; and $V_{RK,c}$ see Annex C3)
- Application without sleeve installed in joints not filled with mortar is not allowed.







Installation:







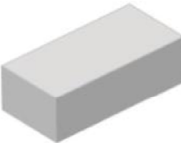
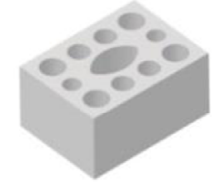
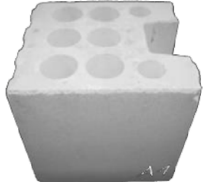

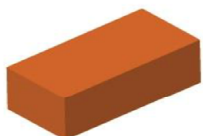
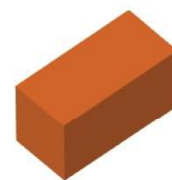
- Dry or wet structures.
- Anchor Installation carried out by appropriately qualified personnel and under the supervision of the person responsible for technical matters of the site.
- Fastening screws or threaded rods (incl. nut and washer) must comply with the appropriate material and property class of the Internal threaded rod .

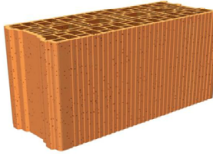
Chemofast Injection System STVK Pro or STVK NORDIC Pro

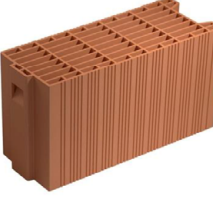
Intended use
Specifications

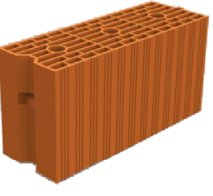
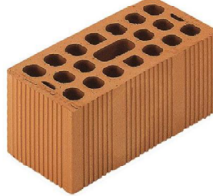
Annex B 1

Table B1: Overview brick types and properties with corresponding fastening elements (Anchor and Sleeves)									
naming density [kg/dm ³] dimensions LxBxH [mm]	picture	anchor rods	perforated sleeve	Annex	naming density [kg/dm ³] dimensions LxBxH [mm]	picture	anchor rods	perforated sleeve	Annex
Autoclaved aerated concrete EN 771-4:2011+A1:2015					solid light weight concrete brick EN 771-3:2011+A1:2015				
AAC $\rho = 0,35-0,60$ $\geq 499 \times 240 \times 249$		M8 - M16 IG-M6 - IG-M10	12x80 16x85 16x130 20x85 20x130 20x200	C4 - C6	VBL $\rho \geq 0,6$ $\geq 240 \times 300 \times 113$		M8 - M16 IG-M6 - IG-M10	12x80 16x85 16x130 20x85 20x130 20x200	C47 - C48
Hollow light weight concrete brick acc. to EN 771-3:2011+A1:2015									
HBL 16DF $\rho \geq 1,0$ 500x250x240		M8 - M16 IG-M6 - IG-M10	16x85 16x130 20x85 20x130 20x200	C43 - C44	Bloc creux B40 $\rho \geq 0,8$ 495x195x190		M8 - M16 IG-M6 - IG-M10	16x130 20x130	C45 - C46
Calcium silica bricks acc. to EN 771-2:2011+A1:2015									
KS $\rho \geq 2,0$ $\geq 240 \times 115 \times 71$		M8 - M16 IG-M6 - IG-M10	12x80 16x85 16x130 20x85 20x130 20x200	C7 - C8	KSL-3DF $\rho \geq 1,4$ 240x175x113		M8 - M16 IG-M6 - IG-M10	16x85 16x130 20x85 20x130	C9 - C10
KSL-8DF $\rho \geq 1,4$ 248x240x238		M8-M16 IG-M6 - IG-M10	16x130 20x130 20x200	C11 - C12	KSL-12DF $\rho \geq 1,4$ 498x175x238		M8 - M16 IG-M6 - IG-M10	16x130 20x130	C13 - C14
Solid clay bricks acc. to EN 771-1:2011+A1:2015									
Mz-1DF $\rho \geq 2,0$ $\geq 240 \times 115 \times 55$		M8 - M16 IG-M6 - IG-M10	12x80 16x85 16x130 20x85 20x130 20x200	C15 - C16	Mz - 2 DF $\rho \geq 2,0$ $\geq 240 \times 115 \times 113$		M8 - M16 IG-M6 - IG-M10	12x80 16x85 16x130 20x85 20x130 20x200	C17 - C18
Chemofast Injection System STVK Pro or STVK NORDIC Pro						Annex B 2			
Intended Use Brick types and properties with corresponding fastening elements									

naming density [kg/dm ³] dimensions LxBxH [mm]	picture	anchor rods	perforated sleeve	Annex	naming density [kg/dm ³] dimensions LxBxH [mm]	picture	anchor rods	perforated sleeve	Annex
Hollow clay bricks acc. to EN 771-1:2011+A1:2015									
Hz-10DF $\rho \geq 1,25$ 300x240x249		M8 - M16 IG-M6 - IG-M10	12x80 16x85 16x130 20x85 20x130 20x200	C19 - C20	Porotherm Homebric $\rho \geq 0,7$ 500x200x299		M8 - M16 IG-M6 - IG-M10	12x80 16x85 16x130 20x85 20x130	C21 - C22
BGV Thermo $\rho \geq 0,6$ 500x200x314		M8 - M16 IG-M6 - IG-M10	12x80 16x85 16x130 20x85 20x130	C23 - C24	Brique creuse C40 $\rho \geq 0,7$ 500x200x200		M8 - M16 IG-M6 - IG-M10	12x80 16x85 16x130 20x85 20x130	C29 - C30
Calibric R+ $\rho \geq 0,6$ 500x200x314		M8 - M16 IG-M6 - IG-M10	12x80 16x85 16x130 20x85 20x130	C25 - C26	Blocchi Leggeri $\rho \geq 0,6$ 250x120x250		M8 - M16 IG-M6 - IG-M10	12x80 16x85 16x130 20x85 20x130	C31 - C32
Urbanbric $\rho \geq 0,7$ 560x200x274		M8 - M16 IG-M6 - IG-M10	12x80 16x85 16x130 20x85 20x130	C27 - C28	Doppio Uni $\rho \geq 0,9$ 250x120x120		M8 - M16 IG-M6 - IG-M10	12x80 16x85 16x130 20x85 20x130	C33 - C34
Hollow Clay brick withintegrated insulation acc. to EN 771-1:2011+A1:2015									
Coriso WS07 $\rho \geq 0,55$ 248x365x249 rock wool		M8 - M16 IG-M6 - IG-M10	12x80 16x85 16x130 20x85 20x130 20x200	C35 - C36	T8P $\rho \geq 0,56$ 248x365x249 perlite		M8 - M16 IG-M6 - IG-M10	12x80 16x85 16x130 20x85 20x130 20x200	C39 - C40
T7MW $\rho \geq 0,59$ 248x365x249 rock wool		M8 - M16 IG-M6 - IG-M10	12x80 16x85 16x130 20x85 20x130 20x200	C37 - C38	MZ90-G $\rho \geq 0,68$ 248x365x249 rock wool		M8 - M16 IG-M6 - IG-M10	12x80 16x85 16x130 20x85 20x130 20x200	C41 - C42
Chemofast Injection System STVK Pro or STVK NORDIC Pro						Annex B 3			
Intended Use Brick types and properties with corresponding fastening elements									

Installation: steel brush RBT



Table B2: Installation parameters in autoaerated concrete AAC and solid masonry (without sleeve)

Anchor size			M8	M10	IG-M6	M12	IG-M8	M16	IG-M10
nominal drill hole diameter	d_0	[mm]	10	12		14		18	
drill hole depth	h_0	[mm]	80	90		100		100	
effective anchorage depth	h_{ef}	[mm]	80	90		100		100	
minimum wall thickness	h_{min}	[mm]	$h_{ef} + 30$						
Diameter of clearance hole in the fixture	$d_f \leq$	[mm]	9	12	7	14	9	18	12
Brush			RBT10	RBT12		RBT14		RBT18	
Diameter of steel brush	$d_b \geq$	[mm]	10,5	12,5		14,5		18,5	

Table B3: Installation parameters in solid and hollow masonry (with sleeve)

Anchor size			M8	M8 / M10 / IG-M6			M12 / M16 / IG-M8 / IG-M10			
sleeve SH			12x80	16x85	16x130	16x130/330	20x85	20x130	20x200	
nominal drill hole diameter	d_0	[mm]	12	16	16	16	20	20	20	
drill hole depth	h_0	[mm]	85	90	135	330	90	135	205	
effective anchorage depth	h_{ef}	[mm]	80	85	130	130	85	130	200	
minimum wall thickness	h_{min}	[mm]	115	115	195	195	115	195	240	
Diameter of clearance hole in the fixture	prepositioned installation	$d_f \leq$	[mm]	9	7 (IG-M6) / 9 (M8) / 12 (M10)			9 (IG-M8) / 12 (IG-M10) / 14 (M12) / 18 (M16)		
	push through installation	$d_f \leq$	[mm]	14	18			22		
Brush			RBT12	RBT16			RBT20			
Diameter of steel brush	d_b	[mm]	12,5	16,5			20,5			

Hand pump (Volume 750 ml)



Chemofast Injection System STVK Pro or STVK NORDIC Pro

Intended Use

Installation parameters and cleaning brush

Annex B 4

**Table B4: Maximum working time and minimum curing time
Chemofast STVK**

Temperature in the base material T	Temperature of cartridge	Gelling- / working time	Minimum curing time in dry base material ¹⁾
0 °C bis + 4 °C	+5 °C bis +40 °C	45 min	7 h
+ 5 °C bis + 9 °C		25 min	2 h
+ 10 °C bis + 19 °C		15 min	80 min
+ 20 °C bis + 29 °C		6 min	45 min
+ 30 °C bis + 34 °C		4 min	25 min
+ 35 °C bis + 39 °C		2 min	20 min
+ 40 °C		1,5 min	15 min

¹⁾ In wet base material the curing time **must** be doubled

**Table B5: Maximum working time and minimum curing time
Chemofast STVK Nordic**

Temperature in the base material T	Temperature of cartridge	Gelling- / working time	Minimum curing time in dry base material ¹⁾
0 °C bis + 4 °C	-20 °C bis +10 °C	10 min	2,5 h
+ 5 °C bis + 9 °C		6 min	80 min
+ 10 °C		6 min	60 min

¹⁾ In wet base material the curing time **must** be doubled

Chemofast Injection System STVK Pro or STVK NORDIC Pro

Intended Use
Gelling and curing times

Annex B 5

Installation Instructions

Preparation of cartridge

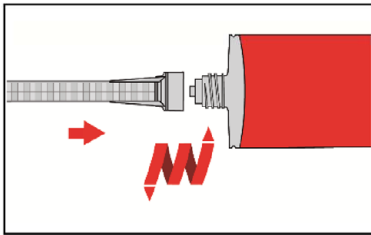

1. Remove the cap and attach the supplied static-mixing nozzle to the cartridge and load the cartridge into the correct dispensing tool. In case of a foil tube cartridge, cut off the clip before use. For every working interruption longer than the recommended working time (Table B4 and B5) as well as for new cartridges, a new static-mixer shall be used.

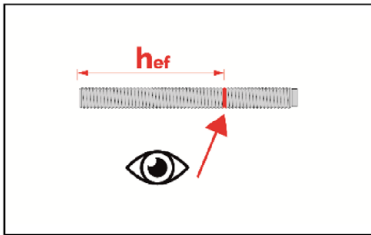

2. The position of the embedment depth shall be marked on the threaded rod.

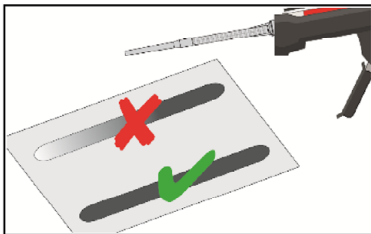

3. Initial adhesive is not suitable for fixing the anchor. Prior to dispensing into the anchor hole, squeeze out separately a minimum of three full strokes, for foil tube cartridges six full strokes and discard non-uniformly mixed adhesive components until the mortar shows a consistent grey colour.

Installation in solid masonry (without sleeve)

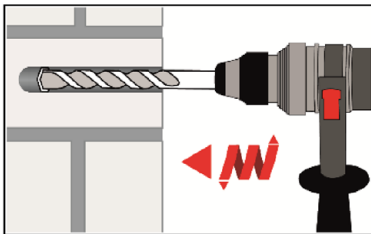

4. Holes to be drilled perpendicular to the surface of the base material by using a hard-metal tipped hammer drill bit. Drill a hole, with drill method according to Annex C4 – C48, into the base material, with nominal drill hole diameter and bore hole depth according to the size and embedment depth required by the selected anchor.

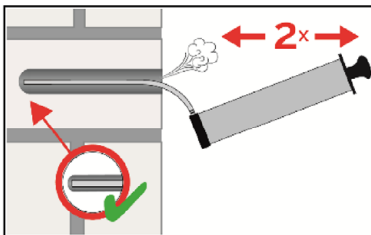

- 5a. Starting from the bottom or back of the bore hole, blow the hole clean with handpump (Annex B4) a minimum of two times.

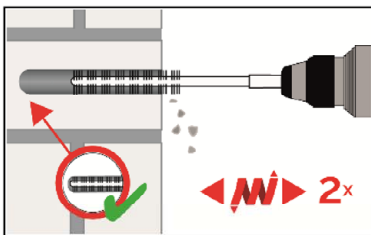

- 5b. Attach an appropriate sized wire brush $> d_{b,min}$ (Table B2) to a drill or a cordless screwdriver and brush the hole clean with a minimum of two times in a twisting motion. If the bore hole ground is not reached with the brush, a brush extension must be used.

Chemofast Injection System STVK Pro or STVK NORDIC Pro

Intended Use

Installation instructions Solid masonry and Autoclaved Aerated Concrete

Annex B 6

Installation instructions (continuation)

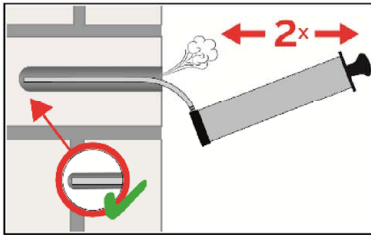

5c. Finally blow the hole clean again with handpump (Annex B4) a minimum of two times

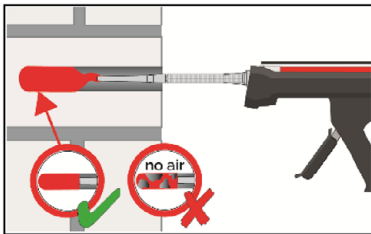

6. Starting from the bottom or back of the cleaned anchor hole, fill the hole up to approximately two-thirds with adhesive. Slowly withdraw the static mixing nozzle as the hole fills to avoid creating air pockets. If the bottom or back of the anchor hole is not reached, an appropriate extension nozzle must be used. Observe the gel-/ working times given in Table B4 + B5.

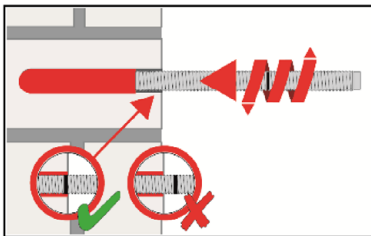

7. Push the threaded rod into the anchor hole while turning slightly to ensure positive distribution of the adhesive until the embedment depth is reached. The anchor shall be free of dirt, grease, oil or other foreign material.

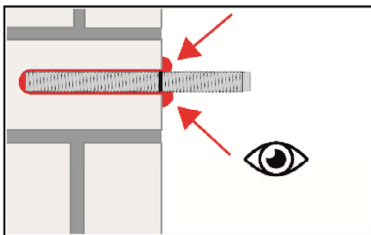

8. Be sure that the annular gap is fully filled with mortar. For push through installation the hole in the fixture must also be fully filled with mortar. If no excess mortar is visible at the top of the hole, the application has to be renewed.

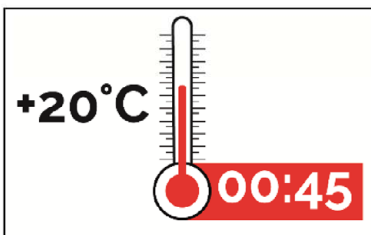

9. Allow the adhesive to cure to the specified curing time prior to applying any load or torque. Do not move or load the anchor until it is fully cured (attend Table B4 + B5).

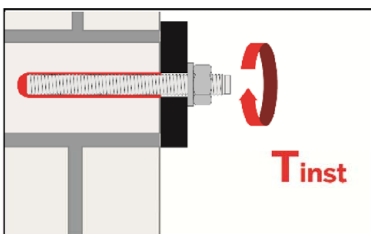

10. After full curing, the fixture can be installed with up to the max. installation torque (See parameters of brick Annex C4 to Annex C48) by using a calibrated torque wrench.

Chemofast Injection System STVK Pro or STVK NORDIC Pro

Intended Use

Installation instructions Solid masonry and Autoclaved Aerated Concrete

Annex B 7

Installation instructions (continuation)

Installation in solid and hollow masonry (with sleeve)

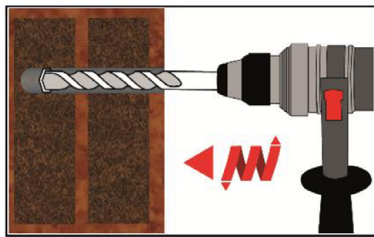

4. Holes to be drilled perpendicular to the surface of the base material by using a hard-metal tipped hammer drill bit. Drill a hole, with drill method according to Annex C4 – C48, into the base material, with nominal drill hole diameter and bore hole depth according to the size and embedment depth required by the selected anchor.

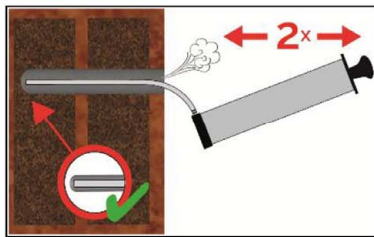

5a. Starting from the bottom or back of the bore hole, blow the hole clean with handpump (Annex B4) a minimum of two times.

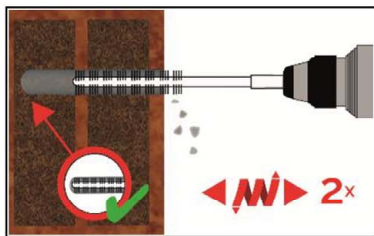

5b. Attach an appropriate sized wire brush $> d_{b,min}$ (Table B3) to a drill or a cordless screwdriver and brush the hole clean with a minimum of two times in a twisting motion. If the bore hole ground is not reached with the brush, a brush extension must be used.

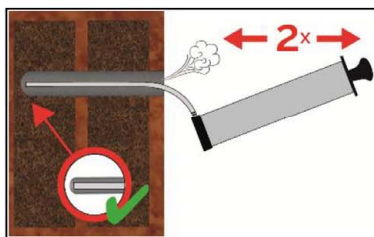

5c. Finally blow the hole clean again with handpump (Annex B4) a minimum of two times

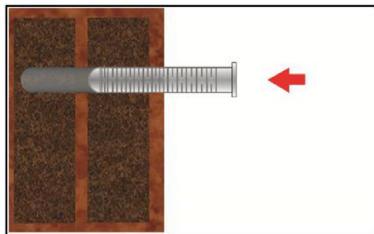

6. Insert the perforated sleeve flush with the surface of the masonry or plaster. Only use sleeves that have the right length. Never cut the sleeve. For installation through insulation the sleeve SH 16x130/330 shall be cutted at the top end according to the insulation thickness.

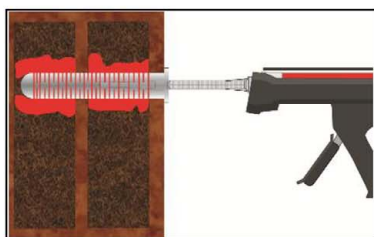

7. Starting from the bottom or back fill the sleeve with adhesive. For embedment depth equal to or larger than 130 mm an extension nozzle shall be used. For quantity of mortar attend cartridges label installation instructions. For push through installation the sleeve within the fixture must also be fully filled with mortar. Observe the gel-/ working times given in Table B4 + B5.

Chemofast Injection System STVK Pro or STVK NORDIC Pro

Intended Use
Installation instructions hollow brick

Annex B 8

Installation instructions (continuation)

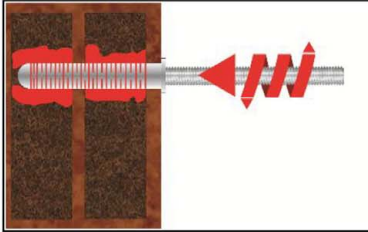

8. Push the threaded rod into the anchor hole while turning slightly to ensure positive distribution of the adhesive until the embedment depth is reached. The anchor shall be free of dirt, grease, oil or other foreign material.

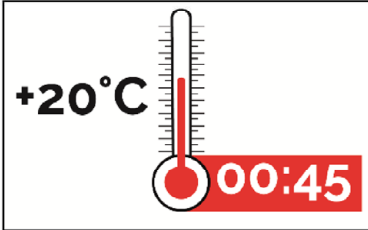

9. Allow the adhesive to cure to the specified curing time prior to applying any load or torque. Do not move or load the anchor until it is fully cured (attend Table B4 + B5).

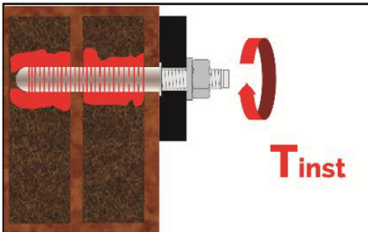

10. After full curing, the fixture can be installed with up to the max. installation torque (See parameters of brick Annex C4 to Annex C48) by using a calibrated torque wrench.

Chemofast Injection System STVK Pro or STVK NORDIC Pro

Intended Use

Installation instructions hollow brick

Annex B 9

Table C1: β -factor for job-site testing under tension loading							
base material	anchor size	β -Factor					
		$T_a: 40^\circ\text{C} / 24^\circ\text{C}$		$T_b: 80^\circ\text{C} / 50^\circ\text{C}$		$T_c: 120^\circ\text{C} / 72^\circ\text{C}$	
		d/d	w/d w/w	d/d	w/d w/w	d/d	w/d w/w
Autoclaved aerated concrete	all sizes	0,95	0,86	0,81	0,73	0,81	0,73
Calcium silica bricks	$d_0 \leq 14$ mm	0,93	0,80	0,87	0,74	0,65	0,56
	$d_0 \geq 16$ mm	0,93	0,93	0,87	0,87	0,65	0,65
Clay Bricks	all sizes	0,86	0,86	0,86	0,86	0,73	0,73
Concrete bricks	$d_0 \leq 12$ mm	0,93	0,80	0,87	0,74	0,65	0,56
	$d_0 \geq 16$ mm	0,93	0,93	0,87	0,87	0,65	0,65
Chemofast Injection System STVK Pro or STVK NORDIC Pro						Annex C 1	
Performances β -factors for job site testing under tension load							

Table C2: Characteristic steel resistance									
Anchor size		IG-M6	IG-M8	IG-M10	M8	M10	M12	M16	
Characteristic tension resistance									
steel, property class 4.6	$N_{Rk,s}$	[kN]	- ¹⁾	- ¹⁾	- ¹⁾	15	23	34	63
	γ_{Ms}	[-]	-			2,0			
steel, property class 4.8	$N_{Rk,s}$	[kN]	- ¹⁾	- ¹⁾	- ¹⁾	15	23	34	63
	γ_{Ms}	[-]	-			1,5			
steel, property class 5.6	$N_{Rk,s}$	[kN]	- ¹⁾	- ¹⁾	- ¹⁾	18	29	42	79
	γ_{Ms}	[-]	-			2,0			
steel, property class 5.8	$N_{Rk,s}$	[kN]	10	17	29	18	29	42	79
	γ_{Ms}	[-]	1,5			1,5			
steel, property class 8.8	$N_{Rk,s}$	[kN]	16	27	46	29	46	67	126
	γ_{Ms}	[-]	1,5			1,5			
Stainless steel A4 / HCR, property class 70	$N_{Rk,s}$	[kN]	14	26	41	26	41	59	110
	γ_{Ms}	[-]	1,87			1,87			
Stainless steel A4 / HCR, property class 80	$N_{Rk,s}$	[kN]	16	29	46	29	46	67	126
	γ_{Ms}	[-]	1,6			1,6			
Characteristic shear resistance									
steel, property class 4.6	$V_{Rk,s}$	[kN]	- ¹⁾	- ¹⁾	- ¹⁾	7	12	17	31
	γ_{Ms}	[-]	-			1,67			
steel, property class 4.8	$V_{Rk,s}$	[kN]	- ¹⁾	- ¹⁾	- ¹⁾	7	12	17	31
	γ_{Ms}	[-]	-			1,25			
steel, property class 5.6	$V_{Rk,s}$	[kN]	- ¹⁾	- ¹⁾	- ¹⁾	9	15	21	39
	γ_{Ms}	[-]	-			1,67			
steel, property class 5.8	$V_{Rk,s}$	[kN]	5	9	15	9	15	21	39
	γ_{Ms}	[-]	1,25			1,25			
steel, property class 8.8	$V_{Rk,s}$	[kN]	8	14	23	15	23	34	63
	γ_{Ms}	[-]	1,25			1,25			
Stainless steel A4 / HCR, property class 70	$V_{Rk,s}$	[kN]	7	13	20	13	20	30	55
	γ_{Ms}	[-]	1,56			1,56			
Stainless steel A4 / HCR, property class 80	$V_{Rk,s}$	[kN]	8	15	23	15	23	34	63
	γ_{Ms}	[-]	1,33			1,33			
Characteristic bending moment									
steel, property class 4.6	$M^0_{Rk,s}$	[Nm]	- ¹⁾	- ¹⁾	- ¹⁾	15	30	52	133
	γ_{Ms}	[-]	-			1,67			
steel, property class 4.8	$M^0_{Rk,s}$	[Nm]	- ¹⁾	- ¹⁾	- ¹⁾	15	30	52	133
	γ_{Ms}	[-]	-			1,25			
steel, property class 5.6	$M^0_{Rk,s}$	[Nm]	- ¹⁾	- ¹⁾	- ¹⁾	19	37	66	167
	γ_{Ms}	[-]	-			1,67			
steel, property class 5.8	$M^0_{Rk,s}$	[Nm]	8	19	37	19	37	66	167
	γ_{Ms}	[-]	1,25			1,25			
steel, property class 8.8	$M^0_{Rk,s}$	[Nm]	12	30	60	30	60	105	266
	γ_{Ms}	[-]	1,25			1,25			
Stainless steel A4 / HCR, property class 70	$M^0_{Rk,s}$	[Nm]	11	26	52	26	52	92	233
	γ_{Ms}	[-]	1,56			1,56			
Stainless steel A4 / HCR, property class 80	$M^0_{Rk,s}$	[Nm]	12	30	60	30	60	105	266
	γ_{Ms}	[-]	1,33			1,33			
¹⁾ Not part of the ETA									
Chemofast Injection System STVK Pro or STVK NORDIC Pro						Annex C 2			
Performances Characteristic resistance under tension and shear load – steel failure									

Load direction		Tension load	Shear load parallel to free edge $V_{ }$	Shear load perpendicular to free edge V_{\perp}
Anchor position	Anchors parallel to horizontal joint $s_{cr, }; (s_{min, })$			
	Anchors perpendicular to horizontal joint $s_{cr,\perp}; (s_{min,\perp})$			

C_{cr} = Characteristic Edge distance
 C_{min} = Minimum Edge distance
 $s_{cr,||}; (s_{min,||})$ = Characteristic (minimum) spacing for anchors placed parallel to horizontal joint
 $s_{cr,\perp}; (s_{min,\perp})$ = Characteristic (minimum) spacing for anchors placed perpendicular to horizontal joint

$\alpha_{edge,N}$ = Reduction factor for tension loads at the free edge (single anchor)
 $\alpha_{edge,V_{\perp}}$ = Reduction factor for shear loads perpendicular to the free edge (single anchor)
 $\alpha_{edge,V_{||}}$ = Reduction factor for shear loads parallel to the free edge (single anchor)
 $\alpha_{g,||,N}$ = Group factor for anchors parallel to horizontal joint under tension load
 $\alpha_{g,\perp,N}$ = Group factor for anchors perpendicular to horizontal joint under tension load
 $\alpha_{g,||,V_{||}}$ = Group factor for anchors parallel to horizontal joint under shear load parallel to the free edge
 $\alpha_{g,\perp,V_{||}}$ = Group factor for anchors perpendicular to horizontal joint under shear load parallel to the free edge
 $\alpha_{g,||,V_{\perp}}$ = Group factor for anchors parallel to horizontal joint under shear load perpendicular to the free edge
 $\alpha_{g,\perp,V_{\perp}}$ = Group factor for anchors perpendicular to hor. joint under shear load perpendicular to the free edge

Single anchor at the edge:
 $N_{RK,b} = \alpha_{edge,N} \cdot N_{RK,b}$
 $V_{RK,c,||} = \alpha_{edge,V_{||}} \cdot V_{RK,b}$
 $V_{RK,c,\perp} = \alpha_{edge,V_{\perp}} \cdot V_{RK,b}$

Group of 2 anchors:
 $N_{RK} = \alpha_{g,N} \cdot N_{RK,b}$
 $V_{RK} = \alpha_{g,V} \cdot V_{RK,b}$ (for $c \geq C_{cr}$)
 $V_{RK,c} = \alpha_{g,V} \cdot V_{RK,b}$ (for $c \geq C_{min}$)

Group of 4 anchors:
 $N_{RK} = \alpha_{g,||,N} \cdot \alpha_{g,\perp,N} \cdot N_{RK,b}$
 $V_{RK} = \alpha_{g,||,V} \cdot \alpha_{g,\perp,V} \cdot V_{RK,b}$ (for $c \geq C_{cr}$)
 $V_{RK,c} = \alpha_{g,||,V} \cdot \alpha_{g,\perp,V} \cdot V_{RK,b}$ (for $c \geq C_{min}$)

Equations depend on anchor position and load direction (see table above). Reduction factor, group factor and resistances see annex C4 - C48. Reduction for installation in joints see annex B1.

Chemofast Injection System STVK Pro or STVK NORDIC Pro	Annex C 3
Performances Definition of the reduction- and group factors	

Brick type: Autoclaved aerated concrete – AAC

Table C3: Stone description

Brick type	Autoclaved aerated concrete AAC		
Density ρ [kg/dm ³]	0,35 – 0,6		
Compressive strength f_b [N/mm ²]	2, 4, 6		
Code	EN 771-4:2011+A1:2015		
Producer (Country)	e.g. Porit (DE)		
Brick dimensions [mm]	$\geq 499 \times 240 \times 249$		
Drilling method	Rotary drilling		

Table C4: Installation parameter

Anchor size		[-]	M8	M10	M12	M16	IG-M6	IG-M8	IG-M10
Installation torque	T_{inst}	[Nm]	≤ 5	≤ 5	≤ 10	≤ 10	≤ 5	≤ 5	≤ 10
Char. Edge distance	c_{cr}	[mm]	150 (for shear loads perpendicular to the free edge: $c_{cr} = 210$)						
Minimum Edge Distance	c_{min}	[mm]	50						
Characteristic Spacing	$s_{cr, II}$	[mm]	300						
	$s_{cr, \perp}$	[mm]	250						
Minimum Spacing	s_{min}	[mm]	50						

Table C5: Reduction factors for single anchors at the edge

Tension load			Shear load					
			Perpendicular to the free edge			Parallel to the free edge		
	with $c \geq$	$\alpha_{edge, N}$		with $c \geq$	$\alpha_{edge, V \perp}$		with $c \geq$	$\alpha_{edge, V II}$
	50	0,85		50	0,12		50	0,70
	150	1,00		125	0,50		125	0,85
				210	1,00		150	1,00

Table C6: Factors for anchor groups under tension load

Anchor position parallel to hor. joint				Anchor position perpendicular to hor. joint			
	with $c \geq$	with $s \geq$	$\alpha_{g II, N}$		with $c \geq$	with $s \geq$	$\alpha_{g \perp, N}$
	50	50	1,10		50	50	0,75
	150	50	1,25		150	50	0,90
	150	300	2,00		150	250	2,00

Table C7: Factors for anchor groups under shear load

		Anchor position parallel to hor. joint				Anchor position perpendicular to hor. joint			
Shear load perpendicular to the free edge		with $c \geq$	with $s \geq$	$\alpha_{g II, V \perp}$		with $c \geq$	with $s \geq$	$\alpha_{g \perp, V \perp}$	
			50	50	0,20		50	50	0,25
		210	50	1,60		210	50	1,80	
		210	300	2,00		210	250	2,00	
Shear load parallel to the free edge		with $c \geq$	with $s \geq$	$\alpha_{g II, V II}$		with $c \geq$	with $s \geq$	$\alpha_{g \perp, V II}$	
		50	50	1,15		50	50	0,80	
		150	50	1,60		150	50	1,10	
		150	300	2,00		150	250	2,00	

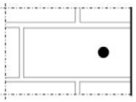
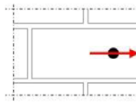
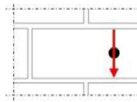
Chemofast Injection System STVK Pro or STVK NORDIC Pro

Performances Autoclaved aerated concrete - AAC

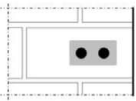
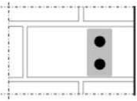
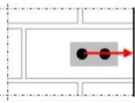
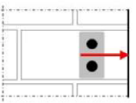
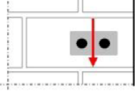
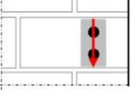
Description of the stone, Installation parameters, Reduction- and Group factors

Annex C 4

Brick type: Autoclaved aerated concrete – AAC

Table C8: Characteristic values of tension and shear load resistances

Anchor size	Perforated sleeve	Effective Anchorage depth	Characteristic Resistances with $c \geq c_{cr}$ and $s \geq s_{cr}$						
			Use condition						
			d/d			w/d w/w			d/d w/d w/w
			40°C/24°C	80°C/50°C	120°C/72°C	40°C/24°C	80°C/50°C	120°C/72°C	All Temperature ranges
h_{ef}	$N_{Rk,b} = N_{Rk,p}$			$N_{Rk,b} = N_{Rk,p}$			$V_{Rk,b}^{1)}$		
[mm]	[kN]								
Compressive strength $f_b = 2 \text{ N/mm}^2$;			Density $\rho \geq 0,35 \text{ kg/dm}^3$						
M8	-	≥ 80	1,2	0,9	0,9	0,9	0,9	0,9	1,5
M10 / IG-M6	-	≥ 90	1,2	0,9	0,9	0,9	0,9	0,9	2,5
M12 / IG-M8	-	≥ 100	2,0	1,5	1,5	1,5	1,5	1,5	2,5
M16 / IG-M10	-	≥ 100	2,0	1,5	1,5	1,5	1,5	1,5	2,5
M8	12x80	80	1,2	0,9	0,9	0,9	0,9	0,9	1,5
M8 / M10 / IG-M6	16x85	85	1,2	0,9	0,9	0,9	0,9	0,9	2,5
	16x130	130	1,2	0,9	0,9	0,9	0,9	0,9	2,5
M12 / M16 / IG-M8 / IG-M10	20x85	85	2,0	1,5	1,5	1,5	1,5	1,5	2,5
	20x130	130	2,0	1,5	1,5	1,5	1,5	1,5	2,5
	20x200	200	2,0	1,5	1,5	1,5	1,5	1,5	2,5

¹⁾ $V_{Rk,c}$ according to Annex C3

Anchor size	Perforated sleeve	Effective Anchorage depth	Characteristic Resistances with $c \geq c_{cr}$ and $s \geq s_{cr}$						
			Use condition						
			d/d			w/d w/w			d/d w/d w/w
			40°C/24°C	80°C/50°C	120°C/72°C	40°C/24°C	80°C/50°C	120°C/72°C	All Temperature ranges
h_{ef}	$N_{Rk,b} = N_{Rk,p}$			$N_{Rk,b} = N_{Rk,p}$			$V_{Rk,b}^{1)}$		
[mm]	[kN]								
Compressive strength $f_b = 4 \text{ N/mm}^2$;			Density $\rho \geq 0,50 \text{ kg/dm}^3$						
M8	-	≥ 80	3,0	2,5	2,0	2,5	2,0	2,0	4,5
M10 / IG-M6	-	≥ 90	3,0	2,5	2,0	2,5	2,0	2,0	7,5
M12 / IG-M8	-	≥ 100	5,0	4,5	4,0	4,5	4,0	4,0	7,5
M16 / IG-M10	-	≥ 100	5,0	4,5	4,0	4,5	4,0	4,0	7,5
M8	12x80	80	3,0	2,5	2,0	2,5	2,0	2,0	4,5
M8 / M10 / IG-M6	16x85	85	3,0	2,5	2,0	2,5	2,0	2,0	7,5
	16x130	130	3,0	2,5	2,0	2,5	2,0	2,0	7,5
M12 / M16 / IG-M8 / IG-M10	20x85	85	5,0	4,5	4,0	4,5	4,0	4,0	7,5
	20x130	130	5,0	4,5	4,0	4,5	4,0	4,0	7,5
	20x200	200	5,0	4,5	4,0	4,5	4,0	4,0	7,5

¹⁾ $V_{Rk,c}$ according to Annex C3

Chemofast Injection System STVK Pro or STVK NORDIC Pro	Annex C 5
Performances Autoclaved aerated concrete - AAC Characteristic Resistances and Displacements	

Brick type: Autoclaved aerated concrete – AAC

Anchor size	Perforated sleeve	Effective Anchorage depth	Characteristic Resistances with $c \geq c_{cr}$ and $s \geq s_{cr}$						
			Use condition						
			d/d			w/d w/w			d/d w/d w/w
			40°C/24°C	80°C/50°C	120°C/72°C	40°C/24°C	80°C/50°C	120°C/72°C	All Temperature ranges
h_{ef}	$N_{Rk,b} = N_{Rk,p}$			$N_{Rk,b} = N_{Rk,p}$			$V_{Rk,b}$ ¹⁾		
[mm]	[kN]								
Compressive strength $f_b = 6 \text{ N/mm}^2$;			Density $\rho \geq 0,65 \text{ kg/dm}^3$						
M8	-	≥ 80	4,0	3,5	3,0	3,5	3,0	3,0	6,0
M10 / IG-M6	-	≥ 90	4,0	3,5	3,0	3,5	3,0	3,0	10,0
M12 / IG-M8	-	≥ 100	7,0	6,0	5,5	6,5	5,5	5,5	10,0
M16 / IG-M10	-	≥ 100	7,0	6,0	5,5	6,5	5,5	5,5	10,0
M8	12x80	80	4,0	3,5	3,0	3,5	3,0	3,0	6,0
M8 / M10/ IG-M6	16x85	85	4,0	3,5	3,0	3,5	3,0	3,0	10,0
	16x130	130	4,0	3,5	3,0	3,5	3,0	3,0	10,0
M12 / M16 / IG-M8 / IG-M10	20x85	85	7,0	6,0	5,5	6,5	5,5	5,5	10,0
	20x130	130	7,0	6,0	5,5	6,5	5,5	5,5	10,0
	20x200	200	7,0	6,0	5,5	6,5	5,5	5,5	10,0

¹⁾ $V_{Rk,c}$ according to Annex C3

Table C9: Displacements

Anchor size	h_{ef}	$\delta N / N$	δN_0	δN_∞	$\delta V / V$	δV_0	δV_∞
	[mm]	[mm/kN]	[mm]	[mm]	[mm/kN]	[mm]	[mm]
M8 – M12, IG-M6 – M10	all	0,1	0,1 * $N_{Rk} / 3,5$	2 * δN_0	0,3	0,3 * $V_{Rk} / 3,5$	1,5 * δV_0
M16	all				0,1	0,1 * $V_{Rk} / 3,5$	1,5 * δV_0

Chemofast Injection System STVK Pro or STVK NORDIC Pro

Performances Autoclaved aerated concrete – AAC
Characteristic Resistances and Displacements

Annex C 6

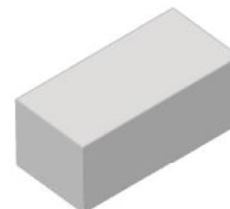

Brick type: Solid calcium silica brick KS-NF

Table C10: Stone description

Brick type	Solid calcium silica brick KS-NF
Density ρ [kg/dm ³]	$\geq 2,0$
Compressive strength f_b [N/mm ²]	≥ 28
Conversion factor for lower compressive strengths	$(f_b / 28)^{0,5} \leq 1,0$
Code	EN 771-2:2011+A1:2015
Producer (Country)	e.g. Wemding (DE)
Brick dimensions [mm]	$\geq 240 \times 115 \times 71$
Drilling method	Hammer drilling

Table C11: Installation parameter

Anchor size		[-]	M8	M10	M12	M16	IG-M6	IG-M8	IG-M10
Installation torque	T_{inst}	[Nm]	≤ 10	≤ 10	≤ 15	≤ 15	≤ 10	≤ 10	≤ 10
Char. Edge distance	c_{cr}	[mm]	150 (for shear loads perpendicular to the free edge: $c_{cr} = 240$)						
Minimum Edge Distance	c_{min}	[mm]	60						
Characteristic Spacing	$s_{cr, II}$	[mm]	240						
	$s_{cr, \perp}$	[mm]	150						
Minimum Spacing	s_{min}	[mm]	75						

Table C12: Reduction factors for single anchors at the edge

Tension load			Shear load					
			Perpendicular to the free edge			Parallel to the free edge		
	with $c \geq$	$\alpha_{edge, N}$		with $c \geq$	$\alpha_{edge, V \perp}$		with $c \geq$	$\alpha_{edge, V II}$
	60	0,50		60	0,30		60	0,60
	100	0,50		100	0,50		100	1,00
	150	1,00		240	1,00		150	1,00

Table C13: Factors for anchor groups under tension load

Anchor position parallel to hor. joint				Anchor position perpendicular to hor. joint			
	with $c \geq$	with $s \geq$	$\alpha_{g II, N}$		with $c \geq$	with $s \geq$	$\alpha_{g \perp, N}$
	60	75	0,70		60	75	1,15
	150	75	1,40		150	75	2,00
	150	240	2,00		150	150	2,00

Table C14: Factors for anchor groups under shear load

		Anchor position parallel to hor. joint			Anchor position perpendicular to hor. joint			
Shear load perpendicular to the free edge		with $c \geq$	with $s \geq$	$\alpha_{g II, V \perp}$		with $c \geq$	with $s \geq$	$\alpha_{g \perp, V \perp}$
		60	75	0,75		60	75	0,90
		150	75	2,00		150	75	2,00
Shear load parallel to the free edge		with $c \geq$	with $s \geq$	$\alpha_{g II, V II}$		with $c \geq$	with $s \geq$	$\alpha_{g \perp, V II}$
		60	75	2,00		60	75	2,00
		150	75	2,00		150	75	2,00
		150	240	2,00		150	150	2,00

Chemofast Injection System STVK Pro or STVK NORDIC Pro

Performances Solid calcium silica brick KS-NF

Description of the stone, Installation parameters, Reduction- and Group factors

Annex C 7

Brick type: Solid calcium silica brick KS-NF									
Table C15: Characteristic values of tension and shear load resistances									
Anchor size	Perforated sleeve	Effective Anchorage depth	Characteristic Resistances with $c \geq c_{cr}$ and $s \geq s_{cr}$						
			Use condition						
			d/d			w/d w/w			d/d w/d w/w
			40°C/24°C	80°C/50°C	120°C/72°C	40°C/24°C	80°C/50°C	120°C/72°C	All Temperature ranges
h_{ef}	$N_{Rk,b} = N_{Rk,p}$			$N_{Rk,b} = N_{Rk,p}$			$V_{Rk,b}^{2)}$		
[mm]	[kN]								
Compressive strength $f_b \geq 28 \text{ N/mm}^2$ ¹⁾									
M8	-	≥ 80	7,0	6,5	5,0	6,0	5,5	4,0	7,0
M10 / IG-M6	-	≥ 90	7,0	6,5	5,0	6,0	5,5	4,0	
M12 / IG-M8	-	≥ 100	7,0	6,5	5,0	6,0	5,5	4,0	
M16 / IG-M10	-	≥ 100	7,0	6,5	5,0	7,0	6,5	5,0	
M8	12x80	80	7,0	6,5	5,0	6,0	5,5	4,0	
M8 / M10/ IG-M6	16x85	85	7,0	6,5	5,0	7,0	6,5	5,0	
	16x130	130	7,0	6,5	5,0	7,0	6,5	5,0	
M12 / M16 / IG-M8 / IG-M10	20x85	85	7,0	6,5	5,0	7,0	6,5	5,0	
	20x130	130	7,0	6,5	5,0	7,0	6,5	5,0	
	20x200	200	7,0	6,5	5,0	7,0	6,5	5,0	
¹⁾ For lower compressive strengths resistances must be multiplied by the conversion factor according to Table C10. ²⁾ $V_{Rk,c}$ according to Annex C3									
Table C16: Displacements									
Anchor size	h_{ef}	$\delta N / N$	δN_0	δN_∞	$\delta V / V$	δV_0	δV_∞		
	[mm]	[mm/kN]	[mm]	[mm]	[mm/kN]	[mm]	[mm]		
M8 – M12, IG-M6 – M10	all	0,1	0,1 * $N_{Rk} / 3,5$	2 * δN_0	0,3	0,3 * $V_{Rk} / 3,5$	1,5 * δV_0		
M16	all				0,1	0,1 * $V_{Rk} / 3,5$	1,5 * δV_0		
Chemofast Injection System STVK Pro or STVK NORDIC Pro					Annex C 8				
Performances Solid calcium silica brick KS-NF Characteristic Resistances and Displacements									

Brick type: Hollow Calcium silica brick KSL-3DF

Table C17: Stone description

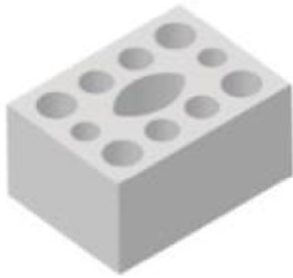
Brick type	Hollow calcium silica brick KSL-3DF		
Density	ρ [kg/dm ³]	≥ 1,4	
Compressive strength	f_b [N/mm ²]	≥ 14	
Conversion factor for lower compressive strengths	$(f_b / 14)^{0,75} \leq 1,0$		
Code	EN 771-2:2011+A1:2015		
Producer (Country)	e.g. KS-Wemding (DE)		
Brick dimensions	[mm]	≥ 240 x 175 x 113	
Drilling method	Rotary drilling		

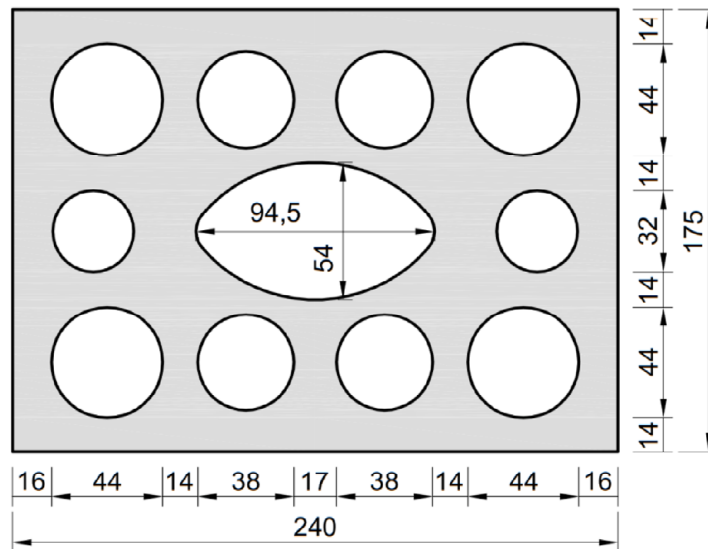
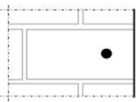
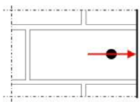
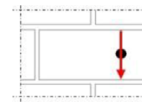

Table C18: Installation parameter

Anchor size		[-]	M8	M10	M12	M16	IG-M6	IG-M8	IG-M10
Installation torque	T_{inst}	[Nm]	≤ 5	≤ 5	≤ 8	≤ 8	≤ 5	≤ 8	≤ 8
Char. Edge distance	c_{cr}	[mm]	120 (for shear loads perpendicular to the free edge: $c_{cr} = 240$)						
Minimum Edge Distance	c_{min}	[mm]	60						
Characteristic Spacing	$s_{cr, II}$	[mm]	240						
	$s_{cr, \perp}$	[mm]	120						
Minimum Spacing	s_{min}	[mm]	120						

Table C19: Reduction factors for single anchors at the edge

Tension load			Shear load					
			Perpendicular to the free edge			Parallel to the free edge		
	with $c \geq$	$\alpha_{edge, N}$		with $c \geq$	$\alpha_{edge, V \perp}$		with $c \geq$	$\alpha_{edge, V II}$
	60	1,00		60	0,30		60	1,00
	120	1,00		240	1,00		120	1,00

Chemofast Injection System STVK Pro or STVK NORDIC Pro

Performances Hollow Calcium silica brick KSL-3DF

Description of the stone, Installation parameters, Reductionfactors

Annex C 9

Brick type: Hollow Calcium silica brick KSL-3DF

Table C20: Factors for anchor groups under tension load

Anchor position parallel to hor. joint				Anchor position perpendicular to hor. joint			
	with $c \geq$	with $s \geq$	$\alpha_{g II, N}$		with $c \geq$	with $s \geq$	$\alpha_{g \perp, N}$
	60	120	1,50		60	120	1,00
	120	120	2,00		120	120	2,00
	120	240	2,00				

Table C21: Factors for anchor groups under shear load

	Anchor position parallel to hor. joint				Anchor position perpendicular to hor. joint			
		with $c \geq$	with $s \geq$	$\alpha_{g II, V \perp}$		with $c \geq$	with $s \geq$	$\alpha_{g \perp, V \perp}$
Shear load perpendicular to the free edge		60	120	0,30		60	120	0,30
		120	120	1,00		240	120	2,00
		120	240	2,00				
Shear load parallel to the free edge		with $c \geq$	with $s \geq$	$\alpha_{g II, V \parallel}$		with $c \geq$	with $s \geq$	$\alpha_{g \perp, V \parallel}$
		60	120	1,00		60	120	1,00
		120	120	1,60		120	120	2,00
		120	120	2,00				

Table C22: Characteristic values of tension and shear load resistances

Anchor size	Perforated sleeve	Effective Anchorage depth	Characteristic Resistances with $c \geq c_{cr}$ and $s \geq s_{cr}$							
			Use condition							
			d/d			w/d w/w			d/d w/d w/w	
			40°C/24°C	80°C/50°C	120°C/72°C	40°C/24°C	80°C/50°C	120°C/72°C	All Temperature ranges	
		h_{ef}	$N_{Rk,b} = N_{Rk,p}$			$N_{Rk,b} = N_{Rk,p}$			$V_{Rk,b}^{2)}$	
		[mm]	[kN]							
Compressive strength $f_b \geq 14 \text{ N/mm}^2$ ¹⁾										
M8 / M10/ IG-M6	16x85	85	2,5	2,5	1,5	2,5	2,5	1,5	6,0	
	16x130	130	2,5	2,5	2,0	2,5	2,5	2,0	6,0	
M12 / M16 / IG-M8 / IG-M10	20x85	85	6,5	6,0	4,5	6,5	6,0	4,5	6,0	
	20x130	130	6,5	6,0	4,5	6,5	6,0	4,5	6,0	

¹⁾ For lower compressive strengths resistances must be multiplied by the conversion factor according to Table C17.

²⁾ $V_{Rk,c}$ according to Annex C3

Table C23: Displacements

Anchor size	h_{ef}	$\delta N / N$	δN_0	δN_{∞}	$\delta V / V$	δV_0	δV_{∞}
	[mm]	[mm/kN]	[mm]	[mm]	[mm/kN]	[mm]	[mm]
M8 – M12, IG-M6 – M10	all	0,13	0,13 * $N_{Rk} / 3,5$	2 * δN_0	0,55	0,55 * $V_{Rk} / 3,5$	1,5 * δV_0
M16	all				0,31	0,31 * $V_{Rk} / 3,5$	1,5 * δV_0

Chemofast Injection System STVK Pro or STVK NORDIC Pro

Performances Hollow Calcium silica brick KSL-3DF
Group factors, characteristic Resistances and Displacements

Annex C 10

Brick type: Hollow Calcium silica brick KSL-8DF

Table C24: Stone description

Brick type	Hollow Calcium silica brick KSL-8DF		
Density ρ [kg/dm ³]	$\geq 1,4$		
Compressive strength f_b [N/mm ²]	≥ 12		
Conversion factor for lower compressive strengths	$(f_b / 12)^{0,75} \leq 1,0$		
Code	EN 771-2:2011+A1:2015		
Producer (Country)	e.g. KS-Wemding (DE)		
Brick dimensions [mm]	$\geq 248 \times 240 \times 238$		
Drilling method	Rotary drilling		

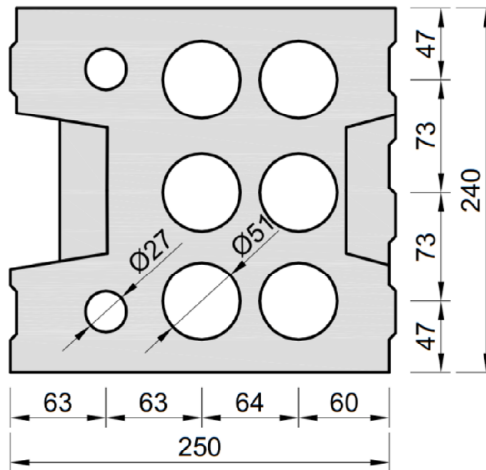
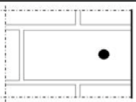
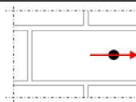
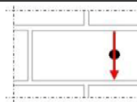

Table C25: Installation parameter

Anchor size		[-]	M8	M10	M12	M16	IG-M6	IG-M8	IG-M10
Installation torque	T_{inst}	[Nm]	≤ 5	≤ 5	≤ 8	≤ 8	≤ 5	≤ 8	≤ 8
Char. Edge distance	c_{cr}	[mm]	120 (for shear loads perpendicular to the free edge: $c_{cr} = 240$)						
Minimum Edge Distance	c_{min}	[mm]	50						
Characteristic Spacing	$s_{cr, II}$	[mm]	250						
	$s_{cr, \perp}$	[mm]	120						
Minimum Spacing	s_{min}	[mm]	50						

Table C26: Reduction factors for single anchors at the edge

Tension load			Shear load					
			Perpendicular to the free edge			Parallel to the free edge		
	with $c \geq$	$\alpha_{edge, N}$		with $c \geq$	$\alpha_{edge, V \perp}$		with $c \geq$	$\alpha_{edge, V II}$
	50	1,00		50	0,30		50	1,00
	120	1,00		250	1,00		120	1,00

Chemofast Injection System STVK Pro or STVK NORDIC Pro

Performances Hollow Calcium silica brick KSL-8DF

Description of the stone, Installation parameters, Reductionfactors

Annex C 11

Brick type: Hollow Calcium silica brick KSL-8DF										
Table C27: Factors for anchor groups under tension load										
Anchor position parallel to hor. joint					Anchor position perpendicular to hor. joint					
	with $c \geq$	with $s \geq$	$\alpha_{g II, N}$			with $c \geq$	with $s \geq$	$\alpha_{g \perp, N}$		
	50	50	1,00			50	50	1,00		
	120	250	2,00			120	120	2,00		
Table C28: Factors for anchor groups under shear load										
Anchor position parallel to hor. joint					Anchor position perpendicular to hor. joint					
Shear load perpendicular to the free edge		with $c \geq$	with $s \geq$	$\alpha_{g II, V \perp}$			with $c \geq$	with $s \geq$	$\alpha_{g \perp, V \perp}$	
		50	50	0,45			50	50	0,45	
		250	50	1,15			250	50	1,20	
Shear load parallel to the free edge		with $c \geq$	with $s \geq$	$\alpha_{g II, V II}$			with $c \geq$	with $s \geq$	$\alpha_{g \perp, V II}$	
		50	50	1,30			50	50	1,00	
		120	250	2,00			120	250	2,00	
Table C29: Characteristic values of tension and shear load resistances										
Anchor size	Perforated sleeve	Effective Anchorage depth	Characteristic Resistances with $c \geq c_{cr}$ and $s \geq s_{cr}$							All Temperature ranges
			Use condition							
			d/d			w/d w/w			d/d w/d w/w	
			40°C/24°C	80°C/50°C	120°C/72°C	40°C/24°C	80°C/50°C	120°C/72°C		
			$N_{Rk,b} = N_{Rk,p}$			$N_{Rk,b} = N_{Rk,p}$			$V_{Rk,b}^{2)}$	
		h_{ef}	[kN]							
		[mm]								
Compressive strength $f_b \geq 12 \text{ N/mm}^2$ ¹⁾										
M8 / M10/ IG-M6	16x130	130	5,0	4,5	3,5	5,0	4,5	3,5	3,5	
M12 / M16 / IG-M8 / IG-M10	20x130	130	5,0	4,5	3,5	5,0	4,5	3,5	6,0	
	20x200	200								
¹⁾ For lower compressive strengths resistances must be multiplied by the conversion factor according to Table C24. ²⁾ $V_{Rk,c}$ according to Annex C3										
Table C30: Displacements										
Anchor size	h_{ef}	$\delta N / N$	δN_0	δN_{∞}	$\delta V / V$	δV_0	δV_{∞}			
	[mm]	[mm/kN]	[mm]	[mm]	[mm]	[mm/kN]	[mm]	[mm]		
M8 – M12, IG-M6 – M10	all	0,13	0,13* N_{Rk} / 3,5	2* δN_0	0,55	0,55* V_{Rk} / 3,5	1,5* δV_0			
M16	all							0,31	0,31* V_{Rk} / 3,5	1,5* δV_0
Chemofast Injection System STVK Pro or STVK NORDIC Pro							Annex C 12			
Performances Hollow Calcium silica brick KSL-8DF Group factors, characteristic Resistances and Displacements										

Brick type: Hollow Calcium silica brick KSL-12DF

Table C31: Stone description

Brick type	Hollow Calcium silica brick KSL-12DF		
Density ρ [kg/dm ³]	$\geq 1,4$		
Compressive strength f_b [N/mm ²]	≥ 12		
Conversion factor for lower compressive strengths	$(f_b / 12)^{0,75} \leq 1,0$		
Code	EN 771-2:2011+A1:2015		
Producer (Country)	e.g. KS-Wemding (DE)		
Brick dimensions [mm]	$\geq 498 \times 175 \times 238$		
Drilling method	Rotary drilling		

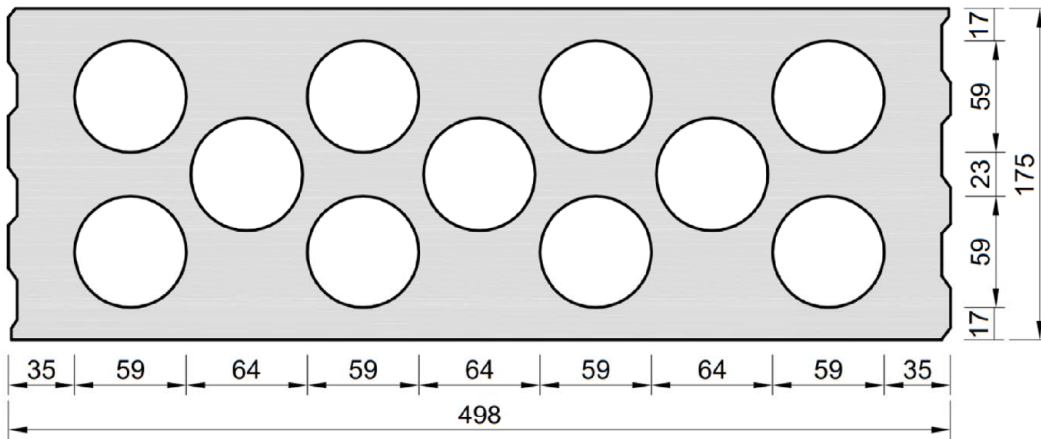
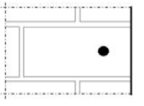
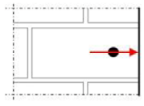
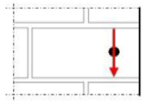

Table C32: Installation parameter

Anchor size		[-]	M8	M10	M12	M16	IG-M6	IG-M8	IG-M10
Installation torque	T_{inst}	[Nm]	≤ 4	≤ 4	≤ 5	≤ 5	≤ 4	≤ 5	≤ 5
Char. Edge distance	c_{cr}	[mm]	120 (for shear loads perpendicular to the free edge: $c_{cr} = 500$)						
Minimum Edge Distance	c_{min}	[mm]	50						
Characteristic Spacing	$s_{cr, II}$	[mm]	500						
	$s_{cr, \perp}$	[mm]	120						
Minimum Spacing	s_{min}	[mm]	50						

Table C33: Reduction factors for single anchors at the edge

Tension load			Shear load					
			Perpendicular to the free edge			Parallel to the free edge		
	with $c \geq$	$\alpha_{edge, N}$		with $c \geq$	$\alpha_{edge, V \perp}$		with $c \geq$	$\alpha_{edge, V II}$
	50	1,00		50	0,45		50	1,00
	120	1,00		500	1,00		120	1,00

Chemofast Injection System STVK Pro or STVK NORDIC Pro

Performances Hollow Calcium silica brick KSL-12DF
Description of the stone, Installation parameters, Reductionfactors

Annex C 13

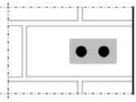
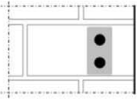
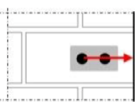
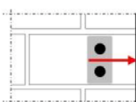
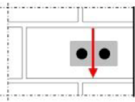
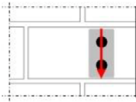
Brick type: Hollow Calcium silica brick KSL-12DF										
Table C34: Factors for anchor groups under tension load										
Anchor position parallel to hor. joint					Anchor position perpendicular to hor. joint					
	with $c \geq$	with $s \geq$	$\alpha_{g \parallel, N}$			with $c \geq$	with $s \geq$	$\alpha_{g \perp, N}$		
	50	50	1,50			50	50	1,00		
	120	500	2,00			120	240	2,00		
Table C35: Factors for anchor groups under shear load										
Anchor position parallel to hor. joint					Anchor position perpendicular to hor. joint					
Shear load perpendicular to the free edge		with $c \geq$	with $s \geq$	$\alpha_{g \parallel, V \perp}$			with $c \geq$	with $s \geq$	$\alpha_{g \perp, V \perp}$	
		50	50	0,55			50	50	0,50	
		500	50	1,00			500	50	1,00	
Shear load parallel to the free edge		with $c \geq$	with $s \geq$	$\alpha_{g \parallel, V \parallel}$			with $c \geq$	with $s \geq$	$\alpha_{g \perp, V \parallel}$	
		50	50	2,00			50	50	1,30	
		120	500	2,00			120	250	2,00	
Table C36: Characteristic values of tension and shear load resistances										
Anchor size	Perforated sleeve	Effective Anchorage depth	Characteristic Resistances with $c \geq c_{cr}$ and $s \geq s_{cr}$							All Temperature ranges
			Use condition							
			d/d			w/d w/w			d/d w/d w/w	
			40°C/24°C	80°C/50°C	120°C/72°C	40°C/24°C	80°C/50°C	120°C/72°C		
			$N_{Rk,b} = N_{Rk,p}$			$N_{Rk,b} = N_{Rk,p}$			$V_{Rk,b}^{2)}$	
		h_{ef}								
		[mm]								[kN]
Compressive strength $f_b \geq 12 \text{ N/mm}^2$ ¹⁾										
M8 / M10 / IG-M6	16x130	130	3,5	3,5	2,5	3,5	3,5	2,5	3,5	
M12 / M16 / IG-M8 / IG-M10	20x130	130	3,5	3,5	2,5	3,5	3,5	2,5	7,0	
¹⁾ For lower compressive strengths resistances must be multiplied by the conversion factor according to Table C31. ²⁾ $V_{Rk,c}$ according to Annex C3										
Table C37: Displacements										
Anchor size	h_{ef}	$\delta N / N$	δN_0	δN_{∞}	$\delta V / V$	δV_0	δV_{∞}			
	[mm]	[mm/kN]	[mm]	[mm]	[mm/kN]	[mm]	[mm]			
M8 – M12, IG-M6 – M10	all	0,13	0,13 * $N_{Rk} / 3,5$	2 * δN_0	0,55	0,55 * $V_{Rk} / 3,5$	1,5 * δV_0			
M16	all				0,31	0,31 * $V_{Rk} / 3,5$	1,5 * δV_0			
Chemofast Injection System STVK Pro or STVK NORDIC Pro							Annex C 14			
Performances Hollow Calcium silica brick KSL-12DF Group factors, characteristic Resistances and Displacements										

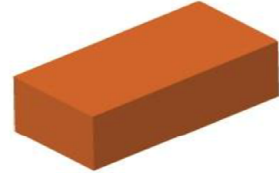

Brick type: Solid clay brick 1DF

Table C38: Stone description

Brick type	Solid clay brick Mz-1DF
Density ρ [kg/dm ³]	$\geq 2,0$
Compressive strength f_b [N/mm ²]	≥ 20
Conversion factor for lower compressive strengths	$(f_b / 20)^{0,5} \leq 1,0$
Code	EN 771-1:2011+A1:2015
Producer (Country)	e.g. Wienerberger (DE)
Brick dimensions [mm]	$\geq 240 \times 115 \times 55$
Drilling method	Hammer drilling

Table C39: Installation parameter

Anchor size		[-]	M8	M10	M12	M16	IG-M6	IG-M8	IG-M10
Installation torque	T_{inst}	[Nm]	≤ 10	≤ 10	≤ 10	≤ 10	≤ 10	≤ 10	≤ 10
Char. Edge distance	c_{cr}	[mm]	150 (for shear loads perpendicular to the free edge: $c_{cr} = 240$)						
Minimum Edge Distance	c_{min}	[mm]	60						
Characteristic Spacing	$s_{cr, II}$	[mm]	240						
	$s_{cr, \perp}$	[mm]	130						
Minimum Spacing	s_{min}	[mm]	65						

Table C40: Reduction factors for single anchors at the edge

Tension load			Shear load					
			Perpendicular to the free edge			Parallel to the free edge		
	with $c \geq$	$\alpha_{edge, N}$		with $c \geq$	$\alpha_{edge, V \perp}$		with $c \geq$	$\alpha_{edge, V II}$
	60	0,75		60	0,10		60	0,30
	150	1,00		100	0,50		100	0,65
				240	1,00		150	1,00

Table C41: Factors for anchor groups under tension load

Anchor position parallel to hor. joint				Anchor position perpendicular to hor. joint			
	with $c \geq$	with $s \geq$	$\alpha_{g II, N}$		with $c \geq$	with $s \geq$	$\alpha_{g \perp, N}$
	60	65	0,85		60	65	1,00
	150	65	1,15		150	65	1,20
	150	240	2,00		150	130	2,00

Table C42: Factors for anchor groups under shear load

		Anchor position parallel to hor. joint				Anchor position perpendicular to hor. joint			
Shear load perpendicular to the free edge		with $c \geq$	with $s \geq$	$\alpha_{g II, V \perp}$		with $c \geq$	with $s \geq$	$\alpha_{g \perp, V \perp}$	
		60	65	0,40		60	65	0,30	
		240	65	2,00		240	65	2,00	
Shear load parallel to the free edge		with $c \geq$	with $s \geq$	$\alpha_{g II, V II}$		with $c \geq$	with $s \geq$	$\alpha_{g \perp, V II}$	
		60	65	1,75		60	65	1,10	
		150	65	2,00		150	65	2,00	
		150	240	2,00		150	130	2,00	

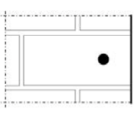
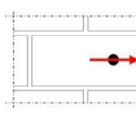
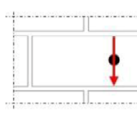
Chemofast Injection System STVK Pro or STVK NORDIC Pro

Performances Solid clay brick 1DF

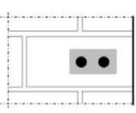
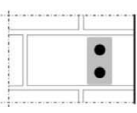
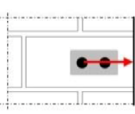
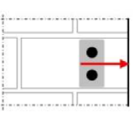
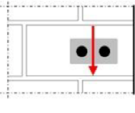
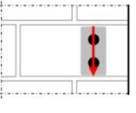
Description of the stone, Installation parameters, Reduction- and Group factors

Annex C 15

Brick type: Solid clay brick 1DF									
Table C43: Characteristic values of tension and shear load resistances									
Anchor size	Perforated sleeve	Effective Anchorage depth	Characteristic Resistances with $c \geq c_{cr}$ and $s \geq s_{cr}$						
			Use condition						
			d/d			w/d w/w			d/d w/d w/w
			40°C/24°C	80°C/50°C	120°C/72°C	40°C/24°C	80°C/50°C	120°C/72°C	All Temperature ranges
h_{ef}	$N_{Rk,b} = N_{Rk,p}$			$N_{Rk,b} = N_{Rk,p}$			$V_{Rk,b}^{2)}$		
[mm]	[kN]								
Compressive strength $f_b \geq 20 \text{ N/mm}^2$ ¹⁾									
M8	-	≥ 80	7,0	6,0	6,0	7,0	6,0	6,0	8,0
M10 / IG-M6	-	≥ 90	7,0	6,0	6,0	7,0	6,0	6,0	8,0
M12 / IG-M8	-	≥ 100	7,0	6,0	6,0	7,0	6,0	6,0	8,0
M16 / IG-M10	-	≥ 100	8,0	6,5	6,5	8,0	6,5	6,5	12,0
M8	12x80	80	7,0	6,0	6,0	7,0	6,0	6,0	8,0
M8 / M10 / IG-M6	16x85	85	7,0	6,0	6,0	7,0	6,0	6,0	8,0
	16x130	130	7,0	6,0	6,0	7,0	6,0	6,0	8,0
M12 / IG-M8	20x85	85	7,0	6,0	6,0	7,0	6,0	6,0	8,0
	20x130	130	7,0	6,0	6,0	7,0	6,0	6,0	8,0
	20x200	200	7,0	6,0	6,0	7,0	6,0	6,0	8,0
M16 / IG-M10	20x85	85	8,0	6,5	6,5	8,0	6,5	6,5	12,0
	20x130	130	8,0	6,5	6,5	8,0	6,5	6,5	12,0
	20x200	200	8,0	6,5	6,5	8,0	6,5	6,5	12,0

¹⁾ For lower compressive strengths resistances must be multiplied by the conversion factor according to Table C38.
²⁾ $V_{Rk,c}$ according to Annex C3

Table C44: Displacements							
Anchor size	h_{ef}	$\delta N / N$	δN_0	δN_∞	$\delta V / V$	δV_0	δV_∞
	[mm]	[mm/kN]	[mm]	[mm]	[mm/kN]	[mm]	[mm]
M8 – M12, IG-M6 – M10	all	0,1	0,1 * $N_{Rk} / 3,5$	2 * δN_0	0,3	0,3 * $V_{Rk} / 3,5$	1,5 * δV_0
M16	all				0,1	0,1 * $V_{Rk} / 3,5$	1,5 * δV_0

Chemofast Injection System STVK Pro or STVK NORDIC Pro	Annex C 16
Performances Solid clay brick 1DF Characteristic Resistances and Displacements	

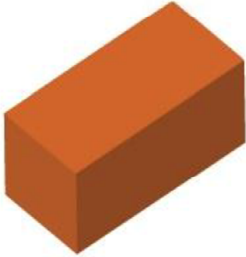
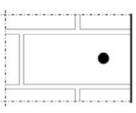
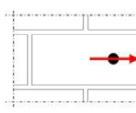
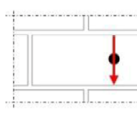
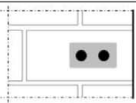
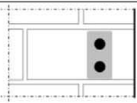
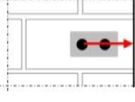
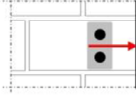
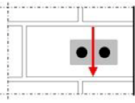
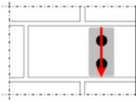
Brick type: Solid clay brick 2DF									
Table C45: Stone description									
Brick type	Solid clay brick Mz- 2DF								
Density	ρ [kg/dm ³]	$\geq 2,0$							
Compressive strength	f_b [N/mm ²]	≥ 28							
Conversion factor for lower compressive strengths	$(f_b / 28)^{0,5} \leq 1,0$								
Code	EN 771-1:2011+A1:2015								
Producer (Country)	e.g. Wienerberger (DE)								
Brick dimensions	[mm]	$\geq 240 \times 115 \times 113$							
Drilling method	Hammer drilling								
									
Table C46: Installation parameter									
Anchor size		[-]	M8	M10	M12	M16	IG-M6	IG-M8	IG-M10
Installation torque	T_{inst}	[Nm]	≤ 10	≤ 10	≤ 10	≤ 10	≤ 10	≤ 10	≤ 10
Char. Edge distance	c_{cr}	[mm]	150 (for shear loads perpendicular to the free edge: $c_{cr} = 240$)						
Minimum Edge Distance	c_{min}	[mm]	50						
Characteristic Spacing	$s_{cr, II}$	[mm]	240						
	$s_{cr, \perp}$	[mm]	240						
Minimum Spacing	s_{min}	[mm]	50						
Table C47: Reduction factors for single anchors at the edge									
Tension load			Shear load						
			Perpendicular to the free edge			Parallel to the free edge			
	with $c \geq$	$\alpha_{edge, N}$		with $c \geq$	$\alpha_{edge, V \perp}$		with $c \geq$	$\alpha_{edge, V II}$	
	50	1,00		50	0,20		50	1,00	
	150	1,00		125	0,50		150	1,00	
				240	1,00				
Table C48: Factors for anchor groups under tension load									
Anchor position parallel to hor. joint				Anchor position perpendicular to hor. joint					
	with $c \geq$	with $s \geq$	$\alpha_{g II, N}$		with $c \geq$	with $s \geq$	$\alpha_{g \perp, N}$		
	50	50	1,50		50	50	0,80		
	150	240	2,00		150	240	2,00		
Table C49: Factors for anchor groups under shear load									
Anchor position parallel to hor. joint				Anchor position perpendicular to hor. joint					
Shear load perpendicular to the free edge		with $c \geq$	with $s \geq$	$\alpha_{g II, V \perp}$		with $c \geq$	with $s \geq$	$\alpha_{g \perp, V \perp}$	
		50	50	0,40		50	50	0,20	
		240	50	1,20		240	50	0,60	
Shear load parallel to the free edge		with $c \geq$	with $s \geq$	$\alpha_{g II, V II}$		with $c \geq$	with $s \geq$	$\alpha_{g \perp, V II}$	
		50	50	1,20		50	50	1,00	
		150	240	2,00		150	240	2,00	
Chemofast Injection System STVK Pro or STVK NORDIC Pro								Annex C 17	
Performances Solid clay brick 2DF Description of the stone, Installation parameters, Reduction- and Group factors									

Brick type: Solid clay brick 2DF									
Table C50: Characteristic values of tension and shear load resistances									
Anchor size	Perforated sleeve	Effective Anchorage depth	Characteristic Resistances with $c \geq c_{cr}$ and $s \geq s_{cr}$						
			Use condition						
			d/d			w/d w/w			d/d w/d w/w
			40°C/24°C	80°C/50°C	120°C/72°C	40°C/24°C	80°C/50°C	120°C/72°C	All Temperature ranges
h_{ef}	$N_{Rk,b} = N_{Rk,p}$			$N_{Rk,b} = N_{Rk,p}$			$V_{Rk,b}^{2)}$		
[mm]	[kN]								
Compressive strength $f_b \geq 28 \text{ N/mm}^2$ ¹⁾									
M8	-	≥ 80	9,0	9,0	7,5	9,0	9,0	7,5	9,5
M10 / IG-M6	-	≥ 90	9,0	9,0	7,5	9,0	9,0	7,5	9,5
M12 / IG-M8	-	≥ 100	9,0	9,0	7,5	9,0	9,0	7,5	12
M16 / IG-M10	-	≥ 100	9,0	9,0	7,5	9,0	9,0	7,5	12 ³⁾
M8	12x80	80	9,0	9,0	7,5	9,0	9,0	7,5	9,5
M8 / M10 / IG-M6	16x85	85	9,0	9,0	7,5	9,0	9,0	7,5	9,5
	16x130	130	9,0	9,0	7,5	9,0	9,0	7,5	9,5
M12 / IG-M8	20x85	85	9,0	9,0	7,5	9,0	9,0	7,5	12
	20x130	130	9,0	9,0	7,5	9,0	9,0	7,5	12
	20x200	200	9,0	9,0	7,5	9,0	9,0	7,5	12
M16 / IG-M10	20x85	85	9,0	9,0	7,5	9,0	9,0	7,5	12 ³⁾
	20x130	130	9,0	9,0	7,5	9,0	9,0	7,5	12 ³⁾
	20x200	200	9,0	9,0	7,5	9,0	9,0	7,5	12 ³⁾

1) For lower compressive strengths resistances must be multiplied by the conversion factor according to Table C45.
2) $V_{Rk,c}$ according to Annex C3
3) Valid for all stone strengths with min. 10 N/mm²

Table C51: Displacements							
Anchor size	h_{ef}	$\delta N / N$	δN_0	δN_{∞}	$\delta V / V$	δV_0	δV_{∞}
	[mm]	[mm/kN]	[mm]	[mm]	[mm/kN]	[mm]	[mm]
M8 – M12, IG-M6 – M10	all	0,1	0,1 * $N_{Rk} / 3,5$	2 * δN_0	0,3	0,3 * $V_{Rk} / 3,5$	1,5 * δV_0
M16	all				0,1	0,1 * $V_{Rk} / 3,5$	1,5 * δV_0

Chemofast Injection System STVK Pro or STVK NORDIC Pro	Annex C 18
Performances Solid clay brick 2DF Characteristic Resistances and Displacements	

Brick type: Hollow clay brick 10 DF

Table C52: Stone description

Brick type	Hollow clay brick HLZ-10DF		
Density ρ [kg/dm ³]	$\geq 1,25$		
Compressive strength f_b [N/mm ²]	≥ 20		
Conversion factor for lower compressive strengths	$(f_b / 20)^{0,5} \leq 1,0$		
Code	EN 771-1:2011+A1:2015		
Producer (Country)	e.g. Wienerberger (DE)		
Brick dimensions [mm]	300 x 240 x 249		
Drilling method	Rotary drilling		

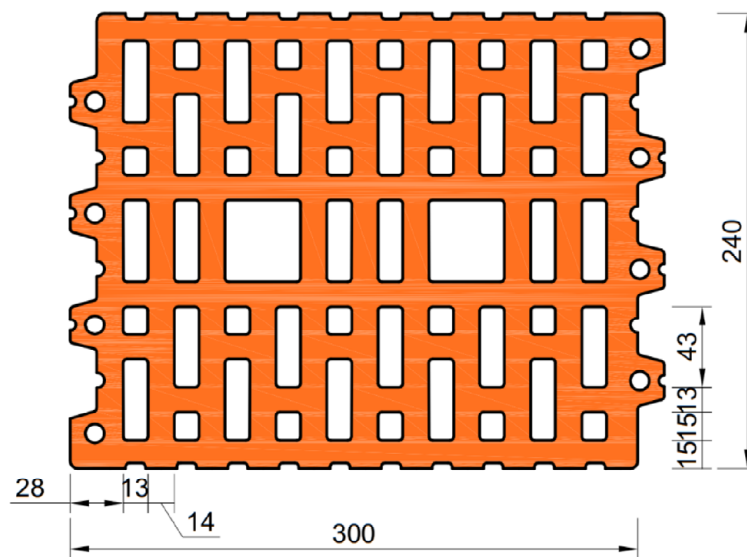
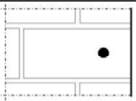
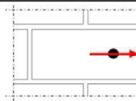
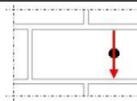

Table C53: Installation parameter

Anchor size		[-]	M8	M10	M12	M16	IG-M6	IG-M8	IG-M10
Installation torque	T_{inst}	[Nm]	≤ 5	≤ 10	≤ 10	≤ 10	≤ 5	≤ 5	≤ 10
Char. Edge distance	c_{cr}	[mm]	120 (for shear loads perpendicular to the free edge: $c_{cr} = 300$)						
Minimum Edge Distance	c_{min}	[mm]	50						
Characteristic Spacing	$s_{cr, II}$	[mm]	300						
	$s_{cr, \perp}$	[mm]	250						
Minimum Spacing	s_{min}	[mm]	50						

Table C54: Reduction factors for single anchors at the edge

Tension load			Shear load					
			Perpendicular to the free edge			Parallel to the free edge		
	with $c \geq$	$\alpha_{edge, N}$		with $c \geq$	$\alpha_{edge, V \perp}$		with $c \geq$	$\alpha_{edge, V II}$
	50	1,00		50	0,20		50	1,00
	120	1,00		300	1,00		120	1,00

Chemofast Injection System STVK Pro or STVK NORDIC Pro

Performances Hollow clay brick HLZ 10DF

Description of the stone, Installation parameters, Reductionfactors

Annex C 19

Brick type: Hollow clay brick 10 DF

Table C55: Factors for anchor groups under tension load

Anchor position parallel to hor. joint				Anchor position perpendicular to hor. joint			
	with $c \geq$	with $s \geq$	$\alpha_{g II, N}$		with $c \geq$	with $s \geq$	$\alpha_{g \perp, N}$
	50	50	1,55		50	50	1,00
	120	300	2,00		120	250	2,00

Table C56: Factors for anchor groups under shear load

	Anchor position parallel to hor. joint				Anchor position perpendicular to hor. joint			
		with $c \geq$	with $s \geq$	$\alpha_{g II, V \perp}$		with $c \geq$	with $s \geq$	$\alpha_{g \perp, V \perp}$
Shear load perpendicular to the free edge		50	50	0,30			50	50
	300	50	1,40	300	50		1,00	
	300	300	2,00	300	250		2,00	
Shear load parallel to the free edge		with $c \geq$	with $s \geq$	$\alpha_{g II, V II}$		with $c \geq$	with $s \geq$	$\alpha_{g \perp, V II}$
		50	50	1,85		50	50	1,00
		120	300	2,00		120	250	2,00

Table C57: Characteristic values of tension and shear load resistances

Anchor size	Perforated sleeve	Effective Anchorage depth	Characteristic Resistances with $c \geq c_{cr}$ and $s \geq s_{cr}$						
			Use condition						
			d/d			w/d w/w			d/d w/d w/w
			40°C/24°C	80°C/50°C	120°C/72°C	40°C/24°C	80°C/50°C	120°C/72°C	All Temperature ranges
		h_{ef}	$N_{Rk,b} = N_{Rk,p}$			$N_{Rk,b} = N_{Rk,p}$			$V_{Rk,b}^{2)}$
		[mm]	[kN]						
Compressive strength $f_b \geq 20 \text{ N/mm}^2$ ¹⁾									
M8	12x80	80	2,5	2,5	2,0	2,5	2,5	2,0	8,0
M8 / M10/ IG-M6	16x85	85	2,5	2,5	2,0	2,5	2,5	2,0	8,0
	16x130	130	2,5	2,5	2,0	2,5	2,5	2,0	8,0
M12 / IG-M8	20x85	85	5,0	5,0	4,5	5,0	5,0	4,5	8,0
	20x130	130	5,0	5,0	4,5	5,0	5,0	4,5	8,0
	20x200	200	5,0	5,0	4,5	5,0	5,0	4,5	8,0
M16 / IG-M10	20x85	85	5,0	5,0	4,5	5,0	5,0	4,5	11,5
	20x130	130	5,0	5,0	4,5	5,0	5,0	4,5	11,5
	20x200	200	5,0	5,0	4,5	5,0	5,0	4,5	11,5

¹⁾ For lower compressive strengths resistances must be multiplied by the conversion factor according to Table C52.

²⁾ $V_{Rk,c}$ according to Annex C3

Table C58: Displacements

Anchor size	h_{ef}	$\delta N / N$	δN_0	δN_{∞}	$\delta v / V$	δv_0	δv_{∞}
	[mm]	[mm/kN]	[mm]	[mm]	[mm/kN]	[mm]	[mm]
M8 – M12, IG-M6 – M10	all	0,13	0,13 * $N_{Rk} / 3,5$	2 * δN_0	0,55	0,55 * $V_{Rk} / 3,5$	1,5 * δv_0
M16	all				0,31	0,31 * $V_{Rk} / 3,5$	1,5 * δv_0

Chemofast Injection System STVK Pro or STVK NORDIC Pro

Performances Hollow clay brick HLZ 10DF

Group factors, characteristic Resistances and Displacements

Annex C 20

Brick type: Hollow Clay brick Porotherm Homebric

Table C59: Stone description

Brick type	Hollow clay brick Porotherm Homebric		
Density	ρ [kg/dm ³]	$\geq 0,70$	
Compressive strength	f_b [N/mm ²]	≥ 10	
Conversion factor for lower compressive strengths	$(f_b / 10)^{0,5} \leq 1,0$		
Code	EN 771-1:2011+A1:2015		
Producer (Country)	e.g. Wienerberger (FR)		
Brick dimensions	[mm]	500 x 200 x 300	
Drilling method	Rotary drilling		

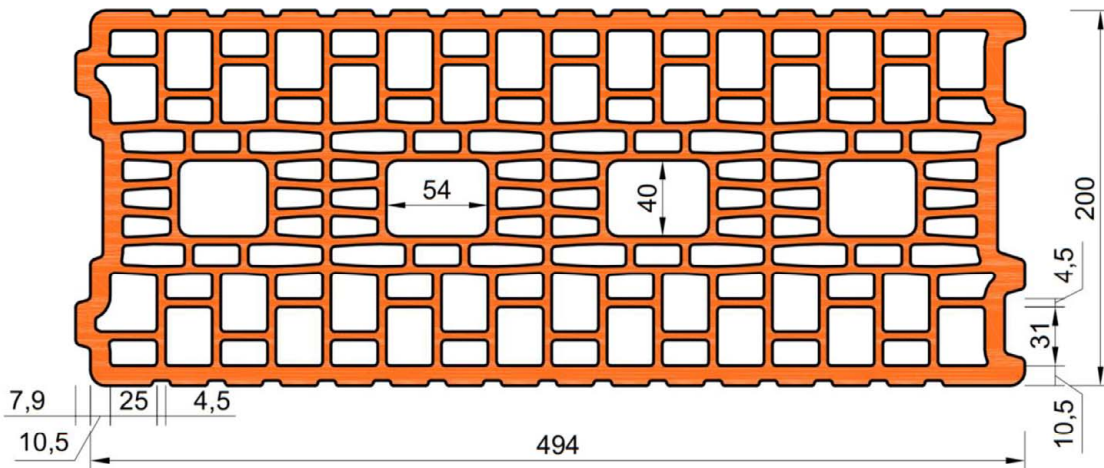
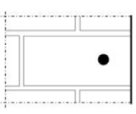
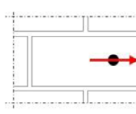
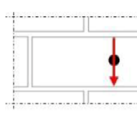

Table C60: Installation parameter

Anchor size		[-]	M8	M10	M12	M16	IG-M6	IG-M8	IG-M10
Installation torque	T_{inst}	[Nm]	≤ 2	≤ 2	≤ 2	≤ 2	≤ 2	≤ 2	≤ 2
Char. Edge distance	c_{cr}	[mm]	120 (for shear loads perpendicular to the free edge: $c_{cr} = 500$)						
Minimum Edge Distance	c_{min}	[mm]	120						
Characteristic Spacing	$s_{cr, II}$	[mm]	500						
	$s_{cr, \perp}$	[mm]	300						
Minimum Spacing	s_{min}	[mm]	120						

Table C61: Reduction factors for single anchors at the edge

Tension load			Shear load					
	with $c \geq$	$\alpha_{edge, N}$	Perpendicular to the free edge			Parallel to the free edge		
	120	1,00		with $c \geq$	$\alpha_{edge, V \perp}$		with $c \geq$	$\alpha_{edge, V II}$
	120	1,00	120	0,30		120	0,60	
	120	1,00	250	0,60		200	1,00	
			500	1,00				

Chemofast Injection System STVK Pro or STVK NORDIC Pro

Performances Hollow clay brick Porotherm Homebric
Description of the stone, Installation parameters, Reductionfactors

Annex C 21

Brick type: Hollow Clay brick Porotherm Homebric

Table C62: Factors for anchor groups under tension load

Anchor position parallel to hor. joint				Anchor position perpendicular to hor. joint			
	with $c \geq$	with $s \geq$	$\alpha_{g II, N}$		with $c \geq$	with $s \geq$	$\alpha_{g \perp, N}$
	120	100	1,00		120	100	1,00
	200	100	2,00		200	100	1,20
	120	500	2,00		120	300	2,00

Table C63: Factors for anchor groups under shear load

		Anchor position parallel to hor. joint			Anchor position perpendicular to hor. joint			
Shear load perpendicular to the free edge		with $c \geq$	with $s \geq$	$\alpha_{g II, V \perp}$		with $c \geq$	with $s \geq$	$\alpha_{g \perp, V \perp}$
		120	100	0,30		120	100	0,30
		250	100	0,60		250	100	0,60
		500	100	1,00		120	300	2,00
Shear load parallel to the free edge		with $c \geq$	with $s \geq$	$\alpha_{g II, V \parallel}$		with $c \geq$	with $s \geq$	$\alpha_{g \perp, V \parallel}$
		120	100	1,00		120	100	1,00
		120	500	2,00		120	300	2,00

Table C64: Characteristic values of tension and shear load resistances

Anchor size	Perforated sleeve	Effective Anchorage depth	Characteristic Resistances with $c \geq c_{cr}$ and $s \geq s_{cr}$						
			Use condition						
			d/d			w/d			d/d
			40°C/24°C	80°C/50°C	120°C/72°C	40°C/24°C	80°C/50°C	120°C/72°C	w/d
		h_{ef}	$N_{Rk,b} = N_{Rk,p}$			$N_{Rk,b} = N_{Rk,p}$			All
		[mm]	[kN]						Temperature ranges
Compressive strength $f_b \geq 10 \text{ N/mm}^2$ ¹⁾									
M8	12x80	80				1,2			3,0
M8 / M10/ IG-M6	16x85	85				1,2			3,0
	16x130	130				1,5			3,5
M12 / M16/ IG-M8 / IG-M10	20x85	85				1,2			4,0
	20x130	130				1,5			4,0
	20x200	200				1,5			4,0

¹⁾ For lower compressive strengths resistances must be multiplied by the conversion factor according to Table C59.

²⁾ $V_{Rk,c}$ according to Annex C3

Table C65: Displacements

Anchor size	h_{ef}	$\delta N / N$	δN_0	δN_{∞}	$\delta v / V$	δv_0	δv_{∞}
	[mm]	[mm/kN]	[mm]	[mm]	[mm/kN]	[mm]	[mm]
M8 – M12, IG-M6 – M10	all	0,13	0,13 * $N_{Rk} / 3,5$	2 * δN_0	0,55	0,55 * $V_{Rk} / 3,5$	1,5 * δv_0
M16	all				0,31	0,31 * $V_{Rk} / 3,5$	1,5 * δv_0

Chemofast Injection System STVK Pro or STVK NORDIC Pro

Performances Hollow clay brick Porotherm Homebric
Group factors, characteristic Resistances and Displacements

Annex C 22

Brick type: Hollow Clay brick BGV Thermo

Table C66: Stone description

Brick type	Hollow clay brick BGV Thermo		
Density ρ [kg/dm ³]	$\geq 0,60$		
Compressive strength f_b [N/mm ²]	≥ 10		
Conversion factor for lower compressive strengths	$(f_b / 10)^{0,5} \leq 1,0$		
Code	EN 771-1:2011+A1:2015		
Producer (Country)	e.g. Leroux (FR)		
Brick dimensions [mm]	500 x 200 x 314		
Drilling method	Rotary drilling		

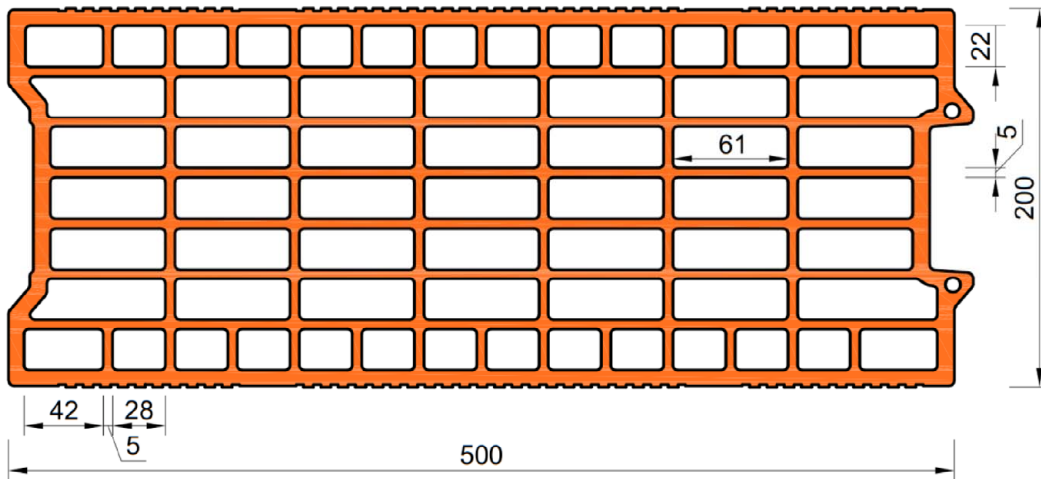
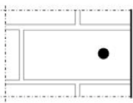
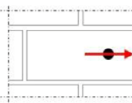
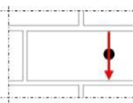

Table C67: Installation parameter

Anchor size		[-]	M8	M10	M12	M16	IG-M6	IG-M8	IG-M10
Installation torque	T_{inst}	[Nm]	≤ 2	≤ 2	≤ 2	≤ 2	≤ 2	≤ 2	≤ 2
Char. Edge distance	c_{cr}	[mm]	120 (for shear loads perpendicular to the free edge: $c_{cr} = 500$)						
Minimum Edge Distance	c_{min}	[mm]	120						
Characteristic Spacing	$s_{cr, II}$	[mm]	500						
	$s_{cr, \perp}$	[mm]	315						
Minimum Spacing	s_{min}	[mm]	120						

Table C68: Reduction factors for single anchors at the edge

Tension load			Shear load					
	with $c \geq$	$\alpha_{edge, N}$	Perpendicular to the free edge			Parallel to the free edge		
	120	1,00		with $c \geq$	$\alpha_{edge, V \perp}$		with $c \geq$	$\alpha_{edge, V II}$
	120	1,00		120	0,30		120	0,60
	120	1,00		250	0,60		250	1,00
	120	1,00		500	1,00		250	1,00

Chemofast Injection System STVK Pro or STVK NORDIC Pro

Performances Hollow clay brick BGV Thermo

Description of the stone, Installation parameters, Reductionfactors

Annex C 23

Brick type: Hollow Clay brick BGV Thermo

Table C69: Factors for anchor groups under tension load

Anchor position parallel to hor. joint				Anchor position perpendicular to hor. joint			
	with $c \geq$	with $s \geq$	$\alpha_{g II, N}$		with $c \geq$	with $s \geq$	$\alpha_{g \perp, N}$
	120	100	1,00		120	100	1,00
	200	100	1,70		200	100	1,10
	120	500	2,00		120	315	2,00

Table C70: Factors for anchor groups under shear load

	Anchor position parallel to hor. joint				Anchor position perpendicular to hor. joint			
		with $c \geq$	with $s \geq$	$\alpha_{g II, V \perp}$		with $c \geq$	with $s \geq$	$\alpha_{g \perp, V \perp}$
Shear load perpendicular to the free edge		120	100	1,00		120	120	100
	120	500	2,00	120	315		2,00	
Shear load parallel to the free edge		with $c \geq$	with $s \geq$	$\alpha_{g II, V \parallel}$		with $c \geq$	with $s \geq$	$\alpha_{g \perp, V \parallel}$
		120	100	1,00		120	100	1,00
		120	500	2,00		120	315	2,00

Table C71: Characteristic values of tension and shear load resistances

Anchor size	Perforated sleeve	Effective Anchorage depth	Characteristic Resistances with $c \geq c_{cr}$ and $s \geq s_{cr}$					
			Use condition					
			d/d			w/d w/w		d/d w/d w/w
			40°C/24°C	80°C/50°C	120°C/72°C	40°C/24°C	80°C/50°C	120°C/72°C
		h_{ef}	$N_{Rk,b} = N_{Rk,p}$			$N_{Rk,b} = N_{Rk,p}$		$V_{Rk,b}^{2)}$
		[mm]	[kN]					
Compressive strength $f_b \geq 10 \text{ N/mm}^2$ ¹⁾								
M8	12x80	80	0,9					3,5
M8 / M10/ IG-M6	16x85	85	0,9					3,5
	16x130	130	2,0	1,5	2,0	1,5	4,0	
M12 / IG-M8	20x85	85	0,9					4,0
	20x130	130	2,0	1,5	2,0	1,5	4,0	
	20x200	200	2,0	1,5	2,0	1,5	4,0	
M16 / IG-M10	20x85	85	0,9					4,0
	20x130	130	2,0	1,5	2,0	1,5	4,0	
	20x200	200	2,0	1,5	2,0	1,5	4,0	

¹⁾ For lower compressive strengths resistances must be multiplied by the conversion factor according to Table C66.

²⁾ $V_{Rk,c}$ according to Annex C3

Table C72: Displacements

Anchor size	h_{ef}	$\delta N / N$	δN_0	δN_{∞}	$\delta V / V$	δV_0	δV_{∞}
	[mm]	[mm/kN]	[mm]	[mm]	[mm/kN]	[mm]	[mm]
M8 – M12, IG-M6 – M10	all	0,13	0,13 * $N_{Rk} / 3,5$	2 * δN_0	0,55	0,55 * $V_{Rk} / 3,5$	1,5 * δV_0
M16	all				0,31	0,31 * $V_{Rk} / 3,5$	1,5 * δV_0

Chemofast Injection System STVK Pro or STVK NORDIC Pro

Performances Hollow clay brick BGV Thermo

Group factors, characteristic Resistances and Displacements

Annex C 24

Brick type: Hollow Clay brick Calibric R+

Table C73: Stone description

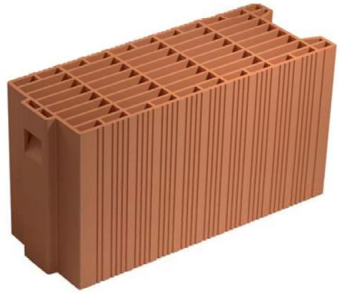
Brick type	Hollow clay brick Calibric R+		
Density ρ [kg/dm ³]	$\geq 0,60$		
Compressive strength f_b [N/mm ²]	≥ 12		
Conversion factor for lower compressive strengths	$(f_b / 12)^{0,5} \leq 1,0$		
Code	EN 771-1:2011+A1:2015		
Producer (Country)	e.g. Leroux (FR)		
Brick dimensions [mm]	500 x 200 x 314		
Drilling method	Rotary drilling		

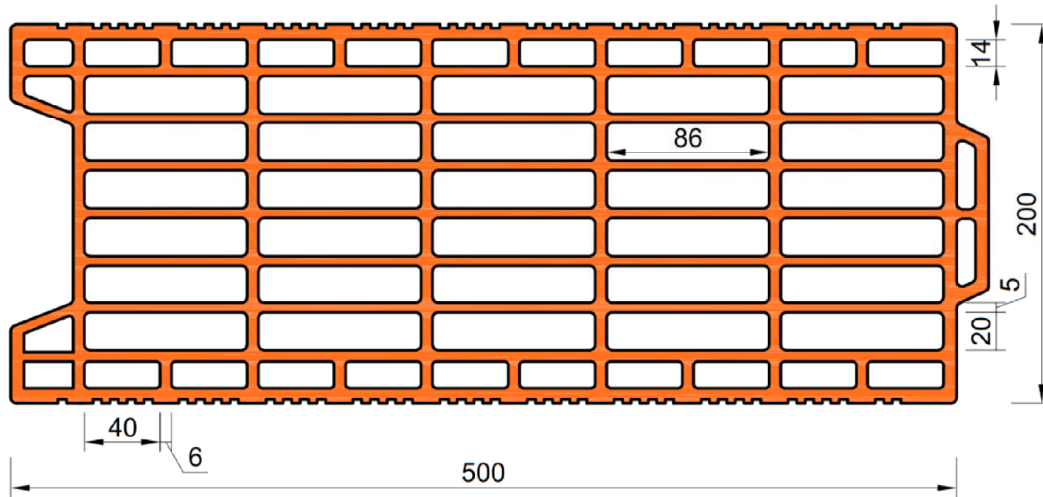
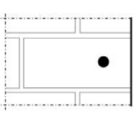
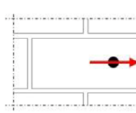
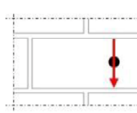

Table C74: Installation parameter

Anchor size		[-]	M8	M10	M12	M16	IG-M6	IG-M8	IG-M10
Installation torque	T_{inst}	[Nm]	≤ 2	≤ 2	≤ 2	≤ 2	≤ 2	≤ 2	≤ 2
Char. Edge distance	c_{cr}	[mm]	120 (for shear loads perpendicular to the free edge: $c_{cr} = 500$)						
Minimum Edge Distance	c_{min}	[mm]	120						
Characteristic Spacing	$s_{cr, II}$	[mm]	500						
	$s_{cr, \perp}$	[mm]	315						
Minimum Spacing	s_{min}	[mm]	120						

Table C75: Reduction factors for single anchors at the edge

Tension load			Shear load					
			Perpendicular to the free edge			Parallel to the free edge		
	with $c \geq$	$\alpha_{edge, N}$		with $c \geq$	$\alpha_{edge, V \perp}$		with $c \geq$	$\alpha_{edge, V II}$
	120	1,00		120	0,15		120	0,30
	120	1,00		250	0,30		250	0,30
	120	1,00		500	1,00		250	1,00

Chemofast Injection System STVK Pro or STVK NORDIC Pro

Performances Hollow clay brick Calibric R+

Description of the stone, Installation parameters, Reduction factors

Annex C 25

Brick type: Hollow Clay brick Calibric R+

Table C76: Factors for anchor groups under tension load

Anchor position parallel to hor. joint				Anchor position perpendicular to hor. joint			
	with $c \geq$	with $s \geq$	$\alpha_{g II, N}$		with $c \geq$	with $s \geq$	$\alpha_{g \perp, N}$
	120	100	1,00		120	100	1,00
	175	100	1,70		175	100	1,10
	120	500	2,00		120	315	2,00

Table C77: Factors for anchor groups under shear load

	Anchor position parallel to hor. joint				Anchor position perpendicular to hor. joint			
		with $c \geq$	with $s \geq$	$\alpha_{g II, V \perp}$		with $c \geq$	with $s \geq$	$\alpha_{g \perp, V \perp}$
Shear load perpendicular to the free edge		120	100	1,00		120	100	1,00
	120	500	2,00	120	315	2,00		
Shear load parallel to the free edge		with $c \geq$	with $s \geq$	$\alpha_{g II, V \parallel}$		with $c \geq$	with $s \geq$	$\alpha_{g \perp, V \parallel}$
		120	100	1,00		120	100	1,00
		120	500	2,00		120	315	2,00

Table C78: Characteristic values of tension and shear load resistances

Anchor size	Perforated sleeve	Effective Anchorage depth	Characteristic Resistances with $c \geq c_{cr}$ and $s \geq s_{cr}$						
			Use condition						
			d/d			w/d w/w			d/d w/d w/w
			40°C/24°C	80°C/50°C	120°C/72°C	40°C/24°C	80°C/50°C	120°C/72°C	All Temperature ranges
		h_{ef}	$N_{Rk,b} = N_{Rk,p}$			$N_{Rk,b} = N_{Rk,p}$			$V_{Rk,b}^{2)}$
		[mm]	[kN]						
Compressive strength $f_b \geq 12 \text{ N/mm}^2$ ¹⁾									
M8	12x80	80	1,2	1,2	0,9	1,2	1,2	0,9	4,0
M8 / M10/ IG-M6	16x85	85	1,2	1,2	0,9	1,2	1,2	0,9	5,5
	16x130	130	1,5	1,5	1,2	1,5	1,5	1,2	5,5
M12 / IG-M8	20x85	85	1,2	1,2	0,9	1,2	1,2	0,9	8,5
	20x130	130	1,5	1,5	1,2	1,5	1,5	1,2	8,5
M16 / IG-M10	20x85	85	1,2	1,2	0,9	1,2	1,2	0,9	8,5
	20x130	130	1,5	1,5	1,2	1,5	1,5	1,2	8,5

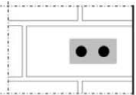
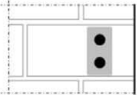
¹⁾ For lower compressive strengths resistances must be multiplied by the conversion factor according to Table C73.

²⁾ $V_{Rk,c}$ according to Annex C3

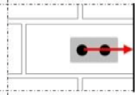
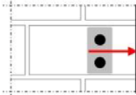
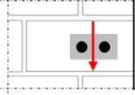
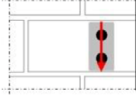
Table C79: Displacements

Anchor size	h_{ef}	$\delta N / N$	δN_0	δN_{∞}	$\delta V / V$	δV_0	δV_{∞}
	[mm]	[mm/kN]	[mm]	[mm]	[mm/kN]	[mm]	[mm]
M8 – M12, IG-M6 – M10	all	0,13	0,13 * $N_{Rk} / 3,5$	2 * δN_0	0,55	0,55 * $V_{Rk} / 3,5$	1,5 * δV_0
M16	all				0,31	0,31 * $V_{Rk} / 3,5$	1,5 * δV_0

Chemofast Injection System STVK Pro or STVK NORDIC Pro

Performances Hollow Clay brick Calibric R+
Group factors, characteristic Resistances and Displacements

Annex C 26

Brick type: Hollow Clay brick Urbanbric

Table C80: Stone description

Brick type	Hollow clay brick Urbanbric	
Density ρ [kg/dm ³]	$\geq 0,70$	
Compressive strength f_b [N/mm ²]	≥ 12	
Conversion factor for lower compressive strengths	$(f_b / 12)^{0,5} \leq 1,0$	
Code	EN 771-1:2011+A1:2015	
Producer (Country)	e.g. Imerys (FR)	
Brick dimensions [mm]	560 x 200 x 274	
Drilling method	Rotary drilling	

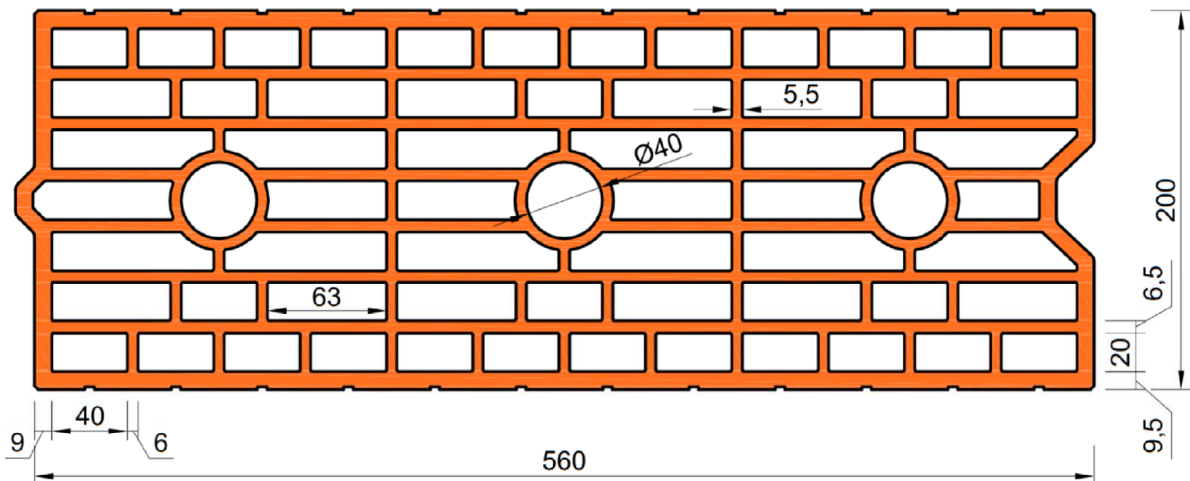
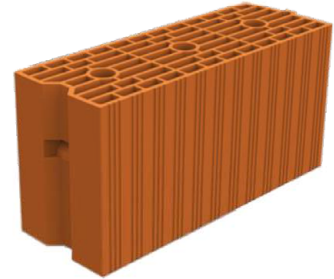

Table C81: Installation parameter

Anchor size		[-]	M8	M10	M12	M16	IG-M6	IG-M8	IG-M10
Installation torque	T_{inst} [Nm]		≤ 2	≤ 2	≤ 2	≤ 2	≤ 2	≤ 2	≤ 2
Char. Edge distance	c_{cr} [mm]		120 (for shear loads perpendicular to the free edge: $c_{cr} = 500$)						
Minimum Edge Distance	c_{min} [mm]		120						
Characteristic Spacing	$s_{cr, II}$ [mm]		560						
	$s_{cr, \perp}$ [mm]		275						
Minimum Spacing	s_{min} [mm]		100						

Table C82: Reduction factors for single anchors at the edge

Tension load			Shear load					
			Perpendicular to the free edge			Parallel to the free edge		
	with $c \geq$	$\alpha_{edge, N}$		with $c \geq$	$\alpha_{edge, V \perp}$		with $c \geq$	$\alpha_{edge, V II}$
	120	1,00		120	0,25		120	0,50
	120	1,00		250	0,50		250	1,00
	120	1,00		500	1,00		250	1,00

Chemofast Injection System STVK Pro or STVK NORDIC Pro

Performances Hollow clay brick Urbanbric

Description of the stone, Installation parameters, Reductionfactors

Annex C 27

Brick type: Hollow Clay brick Urbanbric

Table C83: Factors for anchor groups under tension load

Anchor position parallel to hor. joint				Anchor position perpendicular to hor. joint			
	with $c \geq$	with $s \geq$	$\alpha_{g II, N}$		with $c \geq$	with $s \geq$	$\alpha_{g \perp, N}$
	120	100	1,00		120	100	1,00
	185	100	1,90		185	100	1,10
	120	560	2,00		120	275	2,00

Table C84: Factors for anchor groups under shear load

	Anchor position parallel to hor. joint				Anchor position perpendicular to hor. joint			
		with $c \geq$	with $s \geq$	$\alpha_{g II, V \perp}$		with $c \geq$	with $s \geq$	$\alpha_{g \perp, V \perp}$
Shear load perpendicular to the free edge		120	100	1,00		120	100	1,00
	120	560	2,00	120	275	2,00		
Shear load parallel to the free edge		with $c \geq$	with $s \geq$	$\alpha_{g II, V \parallel}$		with $c \geq$	with $s \geq$	$\alpha_{g \perp, V \parallel}$
		120	100	1,00		120	100	1,00
		120	560	2,00		120	275	2,00

Table C85: Characteristic values of tension and shear load resistances

Anchor size	Perforated sleeve	Effective Anchorage depth	Characteristic Resistances with $c \geq c_{cr}$ and $s \geq s_{cr}$						
			Use condition						
			d/d			w/d w/w			d/d w/d w/w
			40°C/24°C	80°C/50°C	120°C/72°C	40°C/24°C	80°C/50°C	120°C/72°C	All Temperature ranges
		h_{ef}	$N_{Rk,b} = N_{Rk,p}$			$N_{Rk,b} = N_{Rk,p}$			$V_{Rk,b}^{2)}$
		[mm]	[kN]						
Compressive strength $f_b \geq 12 \text{ N/mm}^2$ ¹⁾									
M8	12x80	80	1,2	1,2	0,9	1,2	1,2	0,9	4,5
M8 / M10/ IG-M6	16x85	85	1,2	1,2	0,9	1,2	1,2	0,9	4,5
	16x130	130	3,0	3,0	2,5	3,0	3,0	2,5	4,5
M12 / IG-M8	20x85	85	1,2	1,2	0,9	1,2	1,2	0,9	5,0
	20x130	130	3,0	3,0	2,5	3,0	3,0	2,5	5,0
M16 / IG-M10	20x85	85	1,2	1,2	0,9	1,2	1,2	0,9	5,0
	20x130	130	3,0	3,0	2,5	3,0	3,0	2,5	5,0

¹⁾ For lower compressive strengths resistances must be multiplied by the conversion factor according to Table C80.

²⁾ $V_{Rk,c}$ according to Annex C3

Table C86: Displacements

Anchor size	h_{ef}	$\delta N / N$	δN_0	δN_{∞}	$\delta V / V$	δV_0	δV_{∞}
	[mm]	[mm/kN]	[mm]	[mm]	[mm/kN]	[mm]	[mm]
M8 – M12, IG-M6 – M10	all	0,13	$0,13 \cdot N_{Rk} / 3,5$	$2 \cdot \delta N_0$	0,55	$0,55 \cdot V_{Rk} / 3,5$	$1,5 \cdot \delta V_0$
M16	all				0,31	$0,31 \cdot V_{Rk} / 3,5$	$1,5 \cdot \delta V_0$

Chemofast Injection System STVK Pro or STVK NORDIC Pro

Performances Hollow Clay brick Urbanbric
Group factors, characteristic Resistances and Displacements

Annex C 28

Brick type: Hollow Clay brick Brique creuse C40

Table C87: Stone description

Brick type	Hollow clay brick Brique creuse C40	
Density ρ [kg/dm ³]	$\geq 0,70$	
Compressive strength f_b [N/mm ²]	≥ 12	
Conversion factor for lower compressive strengths	$(f_b / 12)^{0,5} \leq 1,0$	
Code	EN 771-1:2011+A1:2015	
Producer (Country)	e.g. Terreal (FR)	
Brick dimensions [mm]	500 x 200 x 200	
Drilling method	Rotary drilling	

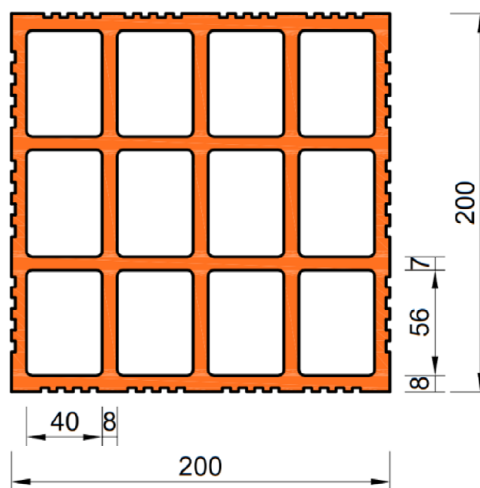

Table C88: Installation parameter

Anchor size		[-]	M8	M10	M12	M16	IG-M6	IG-M8	IG-M10
Installation torque	T_{inst}	[Nm]	≤ 2	≤ 2	≤ 2	≤ 2	≤ 2	≤ 2	≤ 2
Char. Edge distance	c_{cr}	[mm]	120 (for shear loads perpendicular to the free edge: $c_{cr} = 500$)						
Minimum Edge Distance	c_{min}	[mm]	120						
Characteristic Spacing	$s_{cr, II}$	[mm]	500						
	$s_{cr, \perp}$	[mm]	200						
Minimum Spacing	s_{min}	[mm]	200						

Table C89: Reduction factors for single anchors at the edge

Tension load			Shear load					
			Perpendicular to the free edge			Parallel to the free edge		
	with $c \geq$	$\alpha_{edge, N}$		with $c \geq$	$\alpha_{edge, V \perp}$		with $c \geq$	$\alpha_{edge, V II}$
	120	1,00		120	0,83		120	1,00
	120	1,00		500	1,00		250	1,00

Chemofast Injection System STVK Pro or STVK NORDIC Pro

Performances Hollow clay brick Brique Creuse C40

Description of the stone, Installation parameters, Reductionfactors

Annex C 29

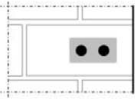
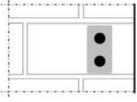
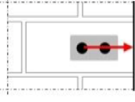
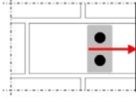
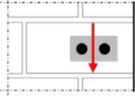
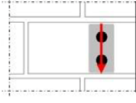
Brick type: Hollow Clay brick Brique creuse C40										
Table C90: Factors for anchor groups under tension load										
Anchor position parallel to hor. joint					Anchor position perpendicular to hor. joint					
	with $c \geq$	with $s \geq$	$\alpha_{g \parallel, N}$			with $c \geq$	with $s \geq$	$\alpha_{g \perp, N}$		
	120	500	2,00			120	200	2,00		
Table C91: Factors for anchor groups under shear load										
Anchor position parallel to hor. joint					Anchor position perpendicular to hor. joint					
Shear load perpendicular to the free edge		with $c \geq$	with $s \geq$	$\alpha_{g \parallel, V \perp}$			with $c \geq$	with $s \geq$	$\alpha_{g \perp, V \perp}$	
		120	500	2,00			120	200	2,00	
Shear load parallel to the free edge		with $c \geq$	with $s \geq$	$\alpha_{g \parallel, V \parallel}$			with $c \geq$	with $s \geq$	$\alpha_{g \perp, V \parallel}$	
		120	500	2,00			120	200	2,00	
Table C92: Characteristic values of tension and shear load resistances										
Anchor size	Perforated sleeve	Effective Anchorage depth	Characteristic Resistances with $c \geq c_{cr}$ and $s \geq s_{cr}$							All Temperature ranges
			Use condition							
			d/d			w/d w/w			d/d w/d w/w	
			40°C/24°C	80°C/50°C	120°C/72°C	40°C/24°C	80°C/50°C	120°C/72°C	V _{Rk,b} ²⁾	
			N _{Rk,b} = N _{Rk,p}			N _{Rk,b} = N _{Rk,p}				
h _{ef}	[kN]						V _{Rk,b} ²⁾			
[mm]	[kN]						V _{Rk,b} ²⁾			
Compressive strength $f_b \geq 12 \text{ N/mm}^2$ ¹⁾										
M8	12x80	80	1,2	1,2	0,9	1,2	1,2	0,9	1,5	
M8 / M10/ IG-M6	16x85	85								
	16x130	130								
M12 / IG-M8	20x85	85								
	20x130	130								
M16 / IG-M10	20x85	85								
	20x130	130								
¹⁾ For lower compressive strengths resistances must be multiplied by the conversion factor according to Table C87. ²⁾ V _{Rk,c} according to Annex C3										
Table C93: Displacements										
Anchor size	h _{ef}	δ_N / N	δ_{N0}	$\delta_{N\infty}$	δ_V / V	δ_{V0}	$\delta_{V\infty}$			
	[mm]	[mm/kN]	[mm]	[mm]	[mm/kN]	[mm]	[mm]			
M8 – M12, IG-M6 – M10	all	0,13	0,13*N _{Rk} / 3,5	2* δ_{N0}	0,55	0,55*V _{Rk} / 3,5	1,5* δ_{V0}			
M16	all				0,31	0,31*V _{Rk} / 3,5	1,5* δ_{V0}			
Chemofast Injection System STVK Pro or STVK NORDIC Pro						Annex C 30				
Performances Hollow Clay brick Brique Creuse C40 Group factors, characteristic Resistances and Displacements										

Brick type: Hollow Clay brick Blocchi Leggeri

Table C94: Stone description

Brick type		Hollow clay brick Blocchi Leggeri	
Density	ρ [kg/dm ³]	$\geq 0,60$	
Compressive strength	f_b [N/mm ²]	≥ 12	
Conversion factor for lower compressive strengths		$(f_b / 12)^{0,5} \leq 1,0$	
Code		EN 771-1:2011+A1:2015	
Producer (Country)		e.g. Wienerberger (IT)	
Brick dimensions	[mm]	250 x 120 x 250	
Drilling method		Rotary drilling	

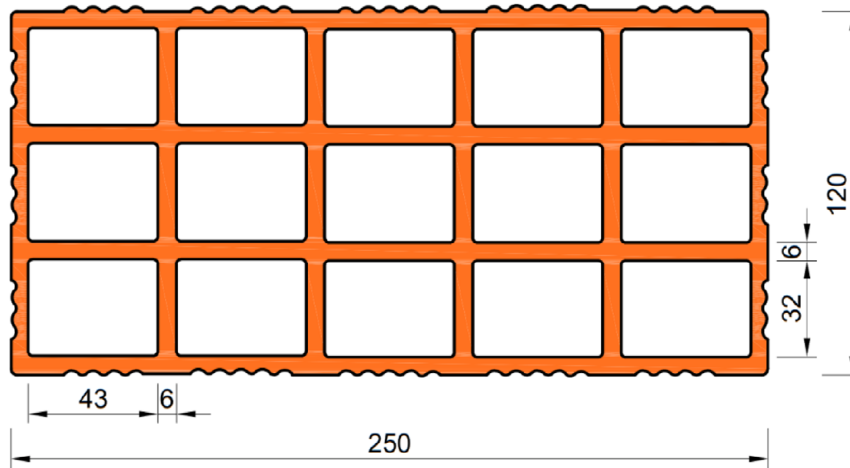
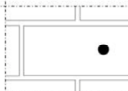
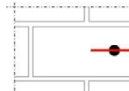



Table C95: Installation parameter

Anchor size		[-]	M8	M10	M12	M16	IG-M6	IG-M8	IG-M10
Installation torque	T_{inst}	[Nm]	≤ 2	≤ 2	≤ 2	≤ 2	≤ 2	≤ 2	≤ 2
Char. Edge distance	c_{cr}	[mm]	120 (for shear loads perpendicular to the free edge: $c_{cr} = 250$)						
Minimum Edge Distance	c_{min}	[mm]	60						
Characteristic Spacing	$s_{cr, II}$	[mm]	250						
	$s_{cr, \perp}$	[mm]	250						
Minimum Spacing	s_{min}	[mm]	100						

Table C96: Reduction factors for single anchors at the edge

Tension load			Shear load					
			Perpendicular to the free edge			Parallel to the free edge		
	with $c \geq$	$\alpha_{edge, N}$		with $c \geq$	$\alpha_{edge, V \perp}$		with $c \geq$	$\alpha_{edge, V II}$
	60	1,00		60	0,40		60	0,40
	120	1,00		250	1,00		120	1,00

Chemofast Injection System STVK Pro or STVK NORDIC Pro

Performances Hollow clay brick Blocchi Leggeri

Description of the stone, Installation parameters, Reductionfactors

Annex C 31

Brick type: Hollow Clay brick Blocchi Leggeri

Table C97: Factors for anchor groups under tension load

Anchor position parallel to hor. joint				Anchor position perpendicular to hor. joint			
	with $c \geq$	with $s \geq$	$\alpha_{g \parallel, N}$		with $c \geq$	with $s \geq$	$\alpha_{g \perp, N}$
	60	100	1,00		60	100	2,00
	120	250	2,00		120	250	2,00

Table C98: Factors for anchor groups under shear load

	Anchor position parallel to hor. joint				Anchor position perpendicular to hor. joint			
		with $c \geq$	with $s \geq$	$\alpha_{g \parallel, V \perp}$		with $c \geq$	with $s \geq$	$\alpha_{g \perp, V \perp}$
Shear load perpendicular to the free edge		60	100	0,40			60	100
	250	100	1,00	250	100		1,00	
	250	250	2,00	250	250		2,00	
Shear load parallel to the free edge	60	100	0,40		60	100	0,40	
	120	100	1,00		120	100	1,00	
	120	250	2,00		120	250	2,00	

Table C99: Characteristic values of tension and shear load resistances

Anchor size	Perforated sleeve	Effective Anchorage depth	Characteristic Resistances with $c \geq c_{cr}$ and $s \geq s_{cr}$						
			Use condition						
			d/d			w/d w/w			d/d w/d w/w
			40°C/24°C	80°C/50°C	120°C/72°C	40°C/24°C	80°C/50°C	120°C/72°C	All Temperature ranges
		h_{ef}	$N_{Rk,b} = N_{Rk,p}$			$N_{Rk,b} = N_{Rk,p}$			$V_{Rk,b}^{2)}$
		[mm]	[kN]						
Compressive strength $f_b \geq 12 \text{ N/mm}^2$ ¹⁾									
M8	12x80	80	0,6	0,6	0,6	0,6	0,6	0,6	3,5
M8 / M10/ IG-M6	16x85	85							
	16x130	130							
M12 / IG-M8	20x85	85							
	20x130	130							
	20x200	200							
M16 / IG-M10	20x85	85							
	20x130	130							
	20x200	200							

¹⁾ For lower compressive strengths resistances must be multiplied by the conversion factor according to Table C94.

²⁾ $V_{Rk,c}$ according to Annex C3

Table C100: Displacements

Anchor size	h_{ef}	$\delta N / N$	δN_0	δN_{∞}	$\delta v / V$	δv_0	δv_{∞}
	[mm]	[mm/kN]	[mm]	[mm]	[mm/kN]	[mm]	[mm]
M8 – M12, IG-M6 – M10	all	0,13	0,13 * $N_{Rk} / 3,5$	2 * δN_0	0,55	0,55 * $V_{Rk} / 3,5$	1,5 * δv_0
M16	all				0,31	0,31 * $V_{Rk} / 3,5$	1,5 * δv_0

Chemofast Injection System STVK Pro or STVK NORDIC Pro

Performances Hollow Clay brick Blocchi Leggeri

Group factors, characteristic Resistances and Displacements

Annex C 32

Brick type: Hollow Clay brick Doppio Uni

Table C101: Stone description

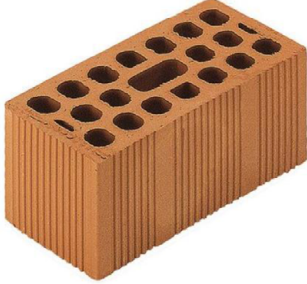
Brick type	Hollow clay brick Doppio Uni		
Density ρ [kg/dm ³]	$\geq 0,90$		
Compressive strength f_b [N/mm ²]	≥ 28		
Conversion factor for lower compressive strengths	$(f_b / 28)^{0,5} \leq 1,0$		
Code	EN 771-1:2011+A1:2015		
Producer (Country)	e.g. Wienerberger (IT)		
Brick dimensions [mm]	250 x 120 x 120		
Drilling method	Rotary drilling		

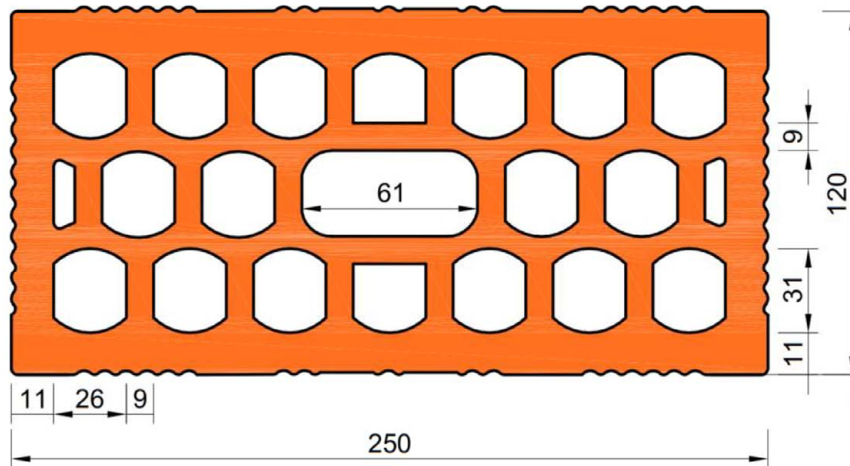
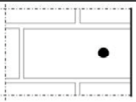
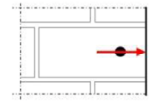
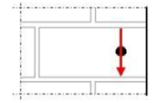

Table C102: Installation parameter

Anchor size		[-]	M8	M10	M12	M16	IG-M6	IG-M8	IG-M10
Installation torque	T_{inst}	[Nm]	≤ 2	≤ 2	≤ 2	≤ 2	≤ 2	≤ 2	≤ 2
Char. Edge distance	c_{cr}	[mm]	120 (for shear loads perpendicular to the free edge: $c_{cr} = 250$)						
Minimum Edge Distance	c_{min}	[mm]	100						
Characteristic Spacing	$s_{cr, II}$	[mm]	250						
	$s_{cr, \perp}$	[mm]	120						
Minimum Spacing	s_{min}	[mm]	100						

Table C103: Reduction factors for single anchors at the edge

Tension load			Shear load					
			Perpendicular to the free edge			Parallel to the free edge		
	with $c \geq$	$\alpha_{edge, N}$		with $c \geq$	$\alpha_{edge, V \perp}$		with $c \geq$	$\alpha_{edge, V II}$
	100	1,00		100	0,50		100	1,00
	120	1,00		250	1,00		120	1,00

Chemofast Injection System STVK Pro or STVK NORDIC Pro

Performances Hollow clay brick Doppio Uni

Description of the stone, Installation parameters, Reductionfactors

Annex C 33

Brick type: Hollow Clay brick Doppio Uni

Table C104: Factors for anchor groups under tension load

Anchor position parallel to hor. joint				Anchor position perpendicular to hor. joint			
	with $c \geq$	with $s \geq$	$\alpha_{g \parallel, N}$		with $c \geq$	with $s \geq$	$\alpha_{g \perp, N}$
	100	100	1,00		100	120	2,00
	120	250	2,00		120	120	2,00

Table C105: Factors for anchor groups under shear load

	Anchor position parallel to hor. joint				Anchor position perpendicular to hor. joint			
		with $c \geq$	with $s \geq$	$\alpha_{g \parallel, V \perp}$		with $c \geq$	with $s \geq$	$\alpha_{g \perp, V \perp}$
Shear load perpendicular to the free edge		100	100	1,00		100	100	100
	250	250	2,00	250	120		2,00	
Shear load parallel to the free edge		with $c \geq$	with $s \geq$	$\alpha_{g \parallel, V \parallel}$		with $c \geq$	with $s \geq$	$\alpha_{g \perp, V \parallel}$
		100	100	1,00		100	100	1,00
		120	250	2,00		120	120	2,00

Table C106: Characteristic values of tension and shear load resistances

Anchor size	Perforated sleeve	Effective Anchorage depth	Characteristic Resistances with $c \geq c_{cr}$ and $s \geq s_{cr}$						
			Use condition						
			d/d			w/d w/w			d/d w/d w/w
			40°C/24°C	80°C/50°C	120°C/72°C	40°C/24°C	80°C/50°C	120°C/72°C	All Temperature ranges
	h_{ef}	$N_{Rk,b} = N_{Rk,p}$			$N_{Rk,b} = N_{Rk,p}$			$V_{Rk,b}^{2)}$	
	[mm]	[kN]							
Compressive strength $f_b \geq 28 \text{ N/mm}^2$ ¹⁾									
M8	12x80	80	1,2	1,2	0,9	1,2	1,2	0,9	2,5
M8 / M10/ IG-M6	16x85	85							
	16x130	130							
M12 / IG-M8	20x85	85							
	20x130	130							
	20x200	200							
M16 / IG-M10	20x85	85							
	20x130	130							
	20x200	200							

¹⁾ For lower compressive strengths resistances must be multiplied by the conversion factor according to Table C101.

²⁾ $V_{Rk,c}$ according to Annex C3

Table C107: Displacements

Anchor size	h_{ef}	$\delta N / N$	δN_0	δN_{∞}	$\delta V / V$	δV_0	δV_{∞}
	[mm]	[mm/kN]	[mm]	[mm]	[mm/kN]	[mm]	[mm]
M8 – M12, IG-M6 – M10	all	0,13	0,13 * $N_{Rk} / 3,5$	2 * δN_0	0,55	0,55 * $V_{Rk} / 3,5$	1,5 * δV_0
M16	all				0,31	0,31 * $V_{Rk} / 3,5$	1,5 * δV_0

Chemofast Injection System STVK Pro or STVK NORDIC Pro

Performances Hollow Clay brick Doppio Uni
Group factors, characteristic Resistances and Displacements

Annex C 34

Brick type: Hollow clay brick Coriso WS07 with insulation

Table C108: Stone description

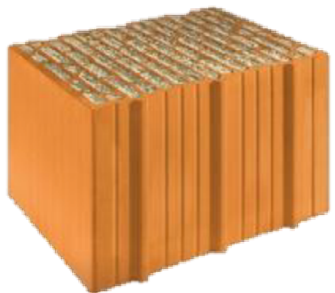
Brick type	Hollow clay brick Coriso WS07		
Insulation material	Rock wool		
Density	ρ [kg/dm ³]	≥ 0,55	
Compressive strength	f_b [N/mm ²]	≥ 6	
Conversion factor for lower compressive strengths	$(f_b / 6)^{0,5} \leq 1,0$		
Code	EN 771-1:2011+A1:2015		
Producer (Country)	e.g. Unipor (DE)		
Brick dimensions	[mm]	248 x 365 x 249	
Drilling method	Rotary drilling		

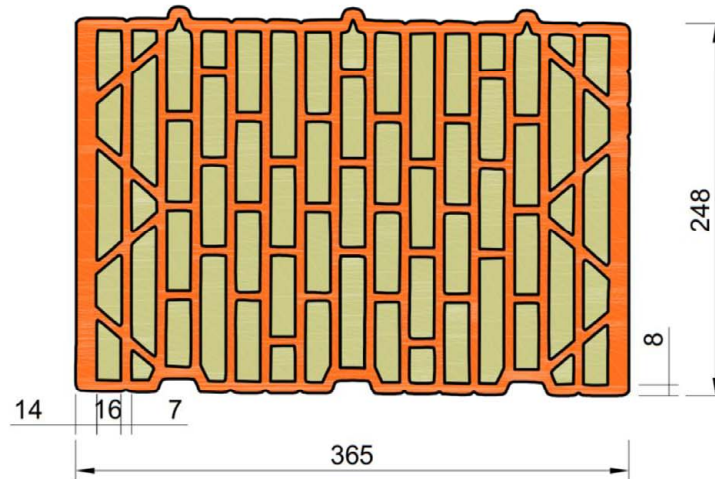
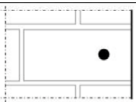
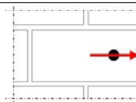
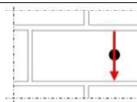

Table C109: Installation parameter

Anchor size		[-]	M8	M10	M12	M16	IG-M6	IG-M8	IG-M10
Installation torque	T_{inst}	[Nm]	≤ 5	≤ 5	≤ 10	≤ 10	≤ 5	≤ 5	≤ 5
Char. Edge distance	c_{cr}	[mm]	120 (for shear loads perpendicular to the free edge: $c_{cr} = 250$)						
Minimum Edge Distance	c_{min}	[mm]	50						
Characteristic Spacing	$s_{cr, II}$	[mm]	250						
	$s_{cr, \perp}$	[mm]	250						
Minimum Spacing	s_{min}	[mm]	50						

Table C110: Reduction factors for single anchors at the edge

Tension load			Shear load					
			Perpendicular to the free edge			Parallel to the free edge		
	with $c \geq$	$\alpha_{edge, N}$		with $c \geq$	$\alpha_{edge, V \perp}$		with $c \geq$	$\alpha_{edge, V \parallel}$
	50	1,00		50	0,30		50	1,00
	120	1,00		250	1,00		120	1,00

Chemofast Injection System STVK Pro or STVK NORDIC Pro

Performances Hollow clay brick Coriso WS07 with insulation
Description of the stone, Installation parameters, Reductionfactors

Annex C 35

Brick type: Hollow clay brick Coriso WS07 with insulation

Table C111: Factors for anchor groups under tension load

Anchor position parallel to hor. joint				Anchor position perpendicular to hor. joint			
	with $c \geq$	with $s \geq$	$\alpha_{g II, N}$		with $c \geq$	with $s \geq$	$\alpha_{g \perp, N}$
	50	50	1,50		50	50	1,00
	120	250	2,00		120	250	2,00

Table C112: Factors for anchor groups under shear load

		Anchor position parallel to hor. joint			Anchor position perpendicular to hor. joint			
Shear load perpendicular to the free edge		with $c \geq$	with $s \geq$	$\alpha_{g II, V \perp}$		with $c \geq$	with $s \geq$	$\alpha_{g \perp, V \perp}$
		50	50	0,40		50	50	0,40
		250	50	1,00		250	50	1,20
		250	250	2,00		250	250	2,00
Shear load parallel to the free edge		with $c \geq$	with $s \geq$	$\alpha_{g II, V II}$		with $c \geq$	with $s \geq$	$\alpha_{g \perp, V II}$
		50	50	1,65		50	50	1,00
		120	250	2,00		120	250	2,00

Table C113: Characteristic values of tension and shear load resistances

Anchor size	Perforated sleeve	Effective Anchorage depth	Characteristic Resistances with $c \geq c_{cr}$ and $s \geq s_{cr}$						
			Use condition						
			d/d			w/d w/w			d/d w/w
			40°C/24°C	80°C/50°C	120°C/72°C	40°C/24°C	80°C/50°C	120°C/72°C	All Temperature ranges
		h_{ef}	$N_{Rk,b} = N_{Rk,p}$			$N_{Rk,b} = N_{Rk,p}$			$V_{Rk,b}^{2)}$
		[mm]	[kN]						
Compressive strength $f_b \geq 6 \text{ N/mm}^2$ ¹⁾									
M8	12x80	80	1,5	1,5	1,5	1,5	1,5	1,5	5,0
M8 / M10/ IG-M6	16x85	85							
	16x130	130							
M12 / IG-M8	20x85	85							
	20x130	130							
	20x200	200							
M16 / IG-M10	20x85	85							
	20x130	130							
	20x200	200							

¹⁾ For lower compressive strengths resistances must be multiplied by the conversion factor according to Table C108.

²⁾ $V_{Rk,c}$ according to Annex C3

Table C114: Displacements

Anchor size	h_{ef}	δ_N / N	δ_{N0}	$\delta_{N\infty}$	δ_V / V	δ_{V0}	$\delta_{V\infty}$
	[mm]	[mm/kN]	[mm]	[mm]	[mm/kN]	[mm]	[mm]
M8 – M12, IG-M6 – M10	all	0,13	0,13* $N_{Rk} / 3,5$	2* δ_{N0}	0,55	0,55* $V_{Rk} / 3,5$	1,5* δ_{V0}
M16	all				0,31	0,31* $V_{Rk} / 3,5$	1,5* δ_{V0}

Chemofast Injection System STVK Pro or STVK NORDIC Pro

Performances Hollow Clay brick Coriso WS07 with insulation
Group factors, characteristic Resistances and Displacements

Annex C 36

Brick type: Hollow clay brick T7 MW with insulation

Table C115: Stone description

Brick type	Hollow clay brick T7 MW
Insulation material	Rock wool
Density ρ [kg/dm ³]	$\geq 0,59$
Compressive strength f_b [N/mm ²]	≥ 8
Conversion factor for lower compressive strengths	$(f_b / 8)^{0,5} \leq 1,0$
Code	EN 771-1:2011+A1:2015
Producer (Country)	e.g. Wienerberger (DE)
Brick dimensions [mm]	248 x 365 x 249
Drilling method	Rotary drilling

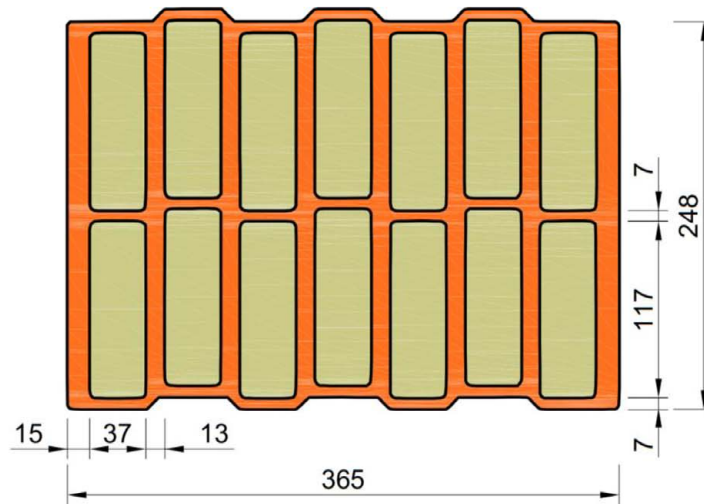

Table C116: Installation parameter

Anchor size		[-]	M8	M10	M12	M16	IG-M6	IG-M8	IG-M10
Installation torque	T_{inst}	[Nm]	≤ 5	≤ 5	≤ 10	≤ 10	≤ 5	≤ 5	≤ 5
Char. Edge distance	c_{cr}	[mm]	120 (for shear loads perpendicular to the free edge: $c_{cr} = 250$)						
Minimum Edge Distance	c_{min}	[mm]	50						
Characteristic Spacing	$s_{cr, II}$	[mm]	250						
	$s_{cr, \perp}$	[mm]	250						
Minimum Spacing	s_{min}	[mm]	50						

Table C117: Reduction factors for single anchors at the edge

Tension load			Shear load					
			Perpendicular to the free edge			Parallel to the free edge		
	with $c \geq$	$\alpha_{edge, N}$		with $c \geq$	$\alpha_{edge, V \perp}$		with $c \geq$	$\alpha_{edge, V II}$
	50	1,00		50	0,35		50	1,00
	120	1,00		250	1,00		120	1,00

Chemofast Injection System STVK Pro or STVK NORDIC Pro

Performances Hollow clay brick T7 MW with insulation
Description of the stone, Installation parameters, Reductionfactors

Annex C 37

Brick type: Hollow clay brick T7 MW with insulation

Table C118: Factors for anchor groups under tension load

Anchor position parallel to hor. joint				Anchor position perpendicular to hor. joint			
	with $c \geq$	with $s \geq$	$\alpha_{g \parallel, N}$		with $c \geq$	with $s \geq$	$\alpha_{g \perp, N}$
	50	50	1,40		50	50	1,15
	120	250	2,00		120	250	2,00

Table C119: Factors for anchor groups under shear load

Anchor position parallel to hor. joint				Anchor position perpendicular to hor. joint				
Shear load perpendicular to the free edge		with $c \geq$	with $s \geq$	$\alpha_{g \parallel, V \perp}$		with $c \geq$	with $s \geq$	$\alpha_{g \perp, V \perp}$
		50	50	0,60		50	50	0,40
		250	50	1,55		250	50	1,00
Shear load parallel to the free edge		with $c \geq$	with $s \geq$	$\alpha_{g \parallel, V \parallel}$		with $c \geq$	with $s \geq$	$\alpha_{g \perp, V \parallel}$
		50	50	2,00		50	50	1,20
		120	250	2,00		120	250	2,00

Table C120: Characteristic values of tension and shear load resistances

Anchor size	Perforated sleeve	Effective Anchorage depth	Characteristic Resistances with $c \geq c_{cr}$ and $s \geq s_{cr}$						All Temperature ranges
			Use condition						
			d/d			w/d w/w			
			40°C/24°C	80°C/50°C	120°C/72°C	40°C/24°C	80°C/50°C	120°C/72°C	
		h_{ef}	$N_{Rk,b} = N_{Rk,p}$			$N_{Rk,b} = N_{Rk,p}$			$V_{Rk,b}^{2)}$
		[mm]	[kN]						
Compressive strength $f_b \geq 8 \text{ N/mm}^2$ ¹⁾									
M8	12x80	80	2,0	2,0	1,5	2,0	2,0	1,5	3,0
M8 / M10/ IG-M6	16x85	85							
	16x130	130							
M12 / IG-M8	20x85	85							
	20x130	130							
	20x200	200							
M16 / IG-M10	20x85	85	4,5						
	20x130	130							
	20x200	200							

¹⁾ For lower compressive strengths resistances must be multiplied by the conversion factor according to Table C115.

²⁾ $V_{Rk,c}$ according to Annex C3

Table C121: Displacements

Anchor size	h_{ef}	δ_N / N	δ_{N0}	$\delta_{N\infty}$	δ_V / V	δ_{V0}	$\delta_{V\infty}$
	[mm]	[mm/kN]	[mm]	[mm]	[mm/kN]	[mm]	[mm]
M8 – M12, IG-M6 – M10	all	0,13	0,13 * $N_{Rk} / 3,5$	2 * δ_{N0}	0,55	0,55 * $V_{Rk} / 3,5$	1,5 * δ_{V0}
M16	all				0,31	0,31 * $V_{Rk} / 3,5$	1,5 * δ_{V0}

Chemofast Injection System STVK Pro or STVK NORDIC Pro

Performances Hollow Clay brick T7 MW with insulation
Group factors, characteristic Resistances and Displacements

Annex C 38

Brick type: Hollow clay brick T8 P with insulation

Table C122: Stone description

Brick type	Hollow clay brick T8 P
Insulation material	Perlite
Density ρ [kg/dm ³]	$\geq 0,56$
Compressive strength f_b [N/mm ²]	≥ 6
Conversion factor for lower compressive strengths	$(f_b / 6)^{0,5} \leq 1,0$
Code	EN 771-1:2011+A1:2015
Producer (Country)	e.g. Wienerberger (DE)
Brick dimensions [mm]	248 x 365 x 249
Drilling method	Rotary drilling

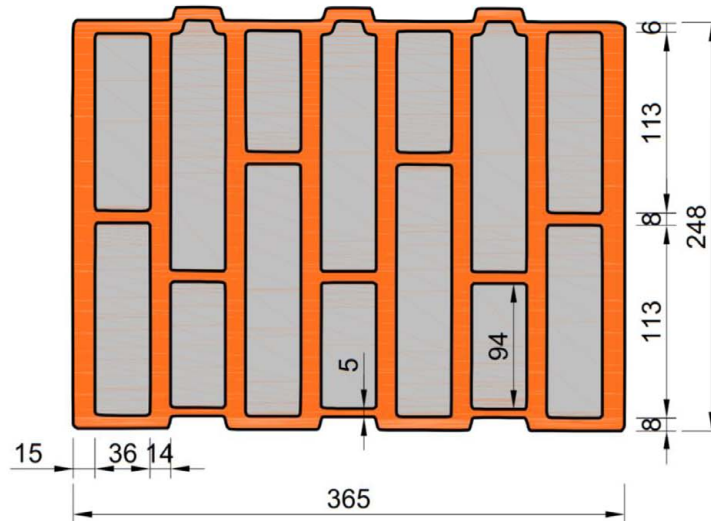

Table C123: Installation parameter

Anchor size		[-]	M8	M10	M12	M16	IG-M6	IG-M8	IG-M10
Installation torque	T_{inst}	[Nm]	≤ 4	≤ 4	≤ 10	≤ 10	≤ 4	≤ 4	≤ 4
Char. Edge distance	c_{cr}	[mm]	120 (for shear loads perpendicular to the free edge: $c_{cr} = 250$)						
Minimum Edge Distance	c_{min}	[mm]	50						
Characteristic Spacing	$s_{cr, II}$	[mm]	250						
	$s_{cr, \perp}$	[mm]	250						
Minimum Spacing	s_{min}	[mm]	50						

Table C124: Reduction factors for single anchors at the edge

Tension load			Shear load					
			Perpendicular to the free edge			Parallel to the free edge		
	with $c \geq$	$\alpha_{edge, N}$		with $c \geq$	$\alpha_{edge, V \perp}$		with $c \geq$	$\alpha_{edge, V II}$
	50	1,00		50	0,25		50	1,00
	120	1,00		250	1,00		120	1,00

Chemofast Injection System STVK Pro or STVK NORDIC Pro

Performances Hollow clay brick T8 P with insulation
Description of the stone, Installation parameters, Reductionfactors

Annex C 39

Brick type: Hollow clay brick T8 P with insulation										
Table C125: Factors for anchor groups under tension load										
Anchor position parallel to hor. joint					Anchor position perpendicular to hor. joint					
	with $c \geq$	with $s \geq$	$\alpha_{g II, N}$			with $c \geq$	with $s \geq$	$\alpha_{g \perp, N}$		
	50	50	1,30			50	50	1,10		
	120	250	2,00			120	250	2,00		
Table C126: Factors for anchor groups under shear load										
Anchor position parallel to hor. joint					Anchor position perpendicular to hor. joint					
Shear load perpendicular to the free edge		with $c \geq$	with $s \geq$	$\alpha_{g II, V \perp}$			with $c \geq$	with $s \geq$	$\alpha_{g \perp, V \perp}$	
		50	50	0,40			50	50	0,30	
		250	50	1,35			250	50	1,20	
Shear load parallel to the free edge		with $c \geq$	with $s \geq$	$\alpha_{g II, V II}$			with $c \geq$	with $s \geq$	$\alpha_{g \perp, V II}$	
		50	50	1,70			50	50	1,00	
		120	250	2,00			120	250	2,00	
Table C127: Characteristic values of tension and shear load resistances										
Anchor size	Perforated sleeve	Effective Anchorage depth	Characteristic Resistances with $c \geq c_{cr}$ and $s \geq s_{cr}$							All Temperature ranges
			Use condition							
			d/d			w/d w/w			d/d w/d w/w	
			40°C/24°C	80°C/50°C	120°C/72°C	40°C/24°C	80°C/50°C	120°C/72°C		
			$N_{Rk,b} = N_{Rk,p}$			$N_{Rk,b} = N_{Rk,p}$			$V_{Rk,b}^{2)}$	
[mm]			[kN]							
Compressive strength $f_b \geq 6 \text{ N/mm}^2$ ¹⁾										
M8	12x80	80	1,5	1,5	1,5	1,5	1,5	1,5	4,5	
M8 / M10/ IG-M6	16x85	85								
	16x130	130								
M12 / IG-M8	20x85	85								
	20x130	130								
M16 / IG-M10	20x200	200	2,5	2,5	2,0	2,5	2,5	2,0	7,0	
	20x85	85								
	20x130	130								
	20x200	200								
¹⁾ For lower compressive strengths resistances must be multiplied by the conversion factor according to Table C122. ²⁾ $V_{Rk,c}$ according to Annex C3										
Table C128: Displacements										
Anchor size	h_{ef}	δ_N / N	δ_{N0}	$\delta_{N\infty}$	δ_V / V	δ_{V0}	$\delta_{V\infty}$			
	[mm]	[mm/kN]	[mm]	[mm]	[mm/kN]	[mm]	[mm]			
M8 – M12, IG-M6 – M10	all	0,13	0,13 * $N_{Rk} / 3,5$	2 * δ_{N0}	0,55	0,55 * $V_{Rk} / 3,5$	1,5 * δ_{V0}			
M16	all				0,31	0,31 * $V_{Rk} / 3,5$	1,5 * δ_{V0}			
Chemofast Injection System STVK Pro or STVK NORDIC Pro							Annex C 40			
Performances Hollow Clay brick T8 P with insulation Group factors, characteristic Resistances and Displacements										

Brick type: Hollow clay brick Thermoplan MZ90-G with insulation

Table C129: Stone description

Brick type	Hollow clay brick Thermoplan MZ90-G		
Insulation material	Rock wool		
Density ρ [kg/dm ³]	$\geq 0,68$		
Compressive strength f_b [N/mm ²]	≥ 12		
Conversion factor for lower compressive strengths	$(f_b / 12)^{0,5} \leq 1,0$		
Code	EN 771-1:2011+A1:2015		
Producer (Country)	e.g. Mein Ziegelhaus (DE)		
Brick dimensions [mm]	248 x 365 x 249		
Drilling method	Rotary drilling		

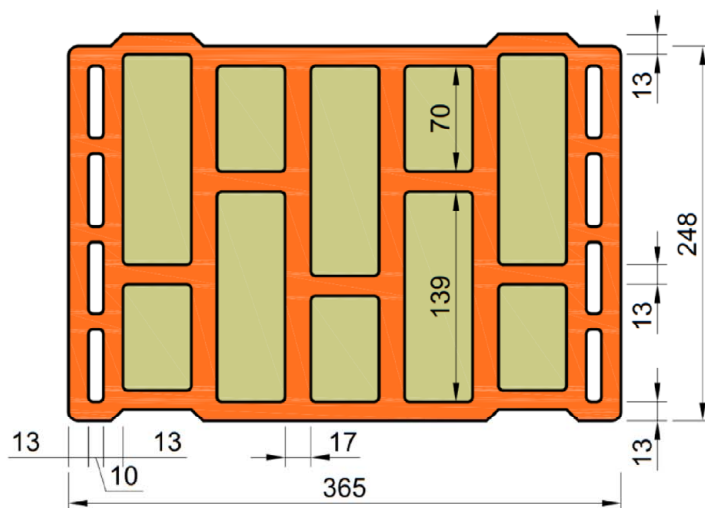
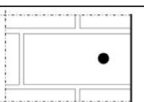
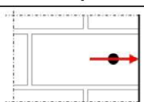
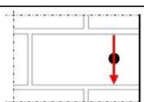

Table C130: Installation parameter

Anchor size		[-]	M8	M10	M12	M16	IG-M6	IG-M8	IG-M10
Installation torque	T_{inst}	[Nm]	≤ 4	≤ 4	≤ 10	≤ 10	≤ 4	≤ 4	≤ 4
Char. Edge distance	c_{cr}	[mm]	120 (for shear loads perpendicular to the free edge: $c_{cr} = 250$)						
Minimum Edge Distance	c_{min}	[mm]	50						
Characteristic Spacing	$s_{cr, II}$	[mm]	250						
	$s_{cr, \perp}$	[mm]	250						
Minimum Spacing	s_{min}	[mm]	50						

Table C131: Reduction factors for single anchors at the edge

Tension load			Shear load					
			Perpendicular to the free edge			Parallel to the free edge		
	with $c \geq$	$\alpha_{edge, N}$		with $c \geq$	$\alpha_{edge, V \perp}$		with $c \geq$	$\alpha_{edge, V II}$
	50	1,00		50	0,25		50	1,00
	120	1,00		250	1,00		120	1,00

Chemofast Injection System STVK Pro or STVK NORDIC Pro

Performances Hollow clay brick Thermoplan MZ90-G with insulation
Description of the stone, Installation parameters, Reductionfactors

Annex C 41

Brick type: Hollow clay brick Thermoplan MZ90-G with insulation

Table C132: Factors for anchor groups under tension load

Anchor position parallel to hor. joint				Anchor position perpendicular to hor. joint			
	with $c \geq$	with $s \geq$	$\alpha_{g II, N}$		with $c \geq$	with $s \geq$	$\alpha_{g \perp, N}$
	50	50	1,00		50	50	1,00
	120	250	2,00		120	250	2,00

Table C133: Factors for anchor groups under shear load

	Anchor position parallel to hor. joint				Anchor position perpendicular to hor. joint			
		with $c \geq$	with $s \geq$	$\alpha_{g II, V \perp}$		with $c \geq$	with $s \geq$	$\alpha_{g \perp, V \perp}$
Shear load perpendicular to the free edge		50	50	0,75			50	50
	250	50	2,00	250	50		1,70	
	250	250	2,00	250	250		2,00	
Shear load parallel to the free edge		with $c \geq$	with $s \geq$	$\alpha_{g II, V II}$		with $c \geq$	with $s \geq$	$\alpha_{g \perp, V II}$
		50	50	1,65		50	50	1,15
		120	250	2,00		120	250	2,00

Table C134: Characteristic values of tension and shear load resistances

Anchor size	Perforated sleeve	Effective Anchorage depth	Characteristic Resistances with $c \geq c_{cr}$ and $s \geq s_{cr}$						
			Use condition						
			d/d			w/d w/w			d/d w/d w/w
			40°C/24°C	80°C/50°C	120°C/72°C	40°C/24°C	80°C/50°C	120°C/72°C	All Temperature ranges
		h_{ef}	$N_{Rk,b} = N_{Rk,p}$			$N_{Rk,b} = N_{Rk,p}$			$V_{Rk,b}^{2)}$
		[mm]	[kN]						
Compressive strength $f_b \geq 12 \text{ N/mm}^2$ ¹⁾									
M8	12x80	80	3,0	3,0	2,5	3,0	3,0	2,5	4,0
M8 / M10/ IG-M6	16x85	85							
	16x130	130							
M12 / IG-M8	20x85	85							
	20x130	130							
	20x200	200							
M16 / IG-M10	20x85	85	3,5	3,5	3,0	3,5	3,5	3,0	7,5
	20x130	130							
	20x200	200							

¹⁾ For lower compressive strengths resistances must be multiplied by the conversion factor according to Table C129.

²⁾ $V_{Rk,c}$ according to Annex C3

Table C135: Displacements

Anchor size	h_{ef}	$\delta N / N$	δN_0	δN_{∞}	$\delta V / V$	δV_0	δV_{∞}
	[mm]	[mm/kN]	[mm]	[mm]	[mm/kN]	[mm]	[mm]
M8 – M12, IG-M6 – M10	all	0,13	0,13 * $N_{Rk} / 3,5$	2 * δN_0	0,55	0,55 * $V_{Rk} / 3,5$	1,5 * δV_0
M16	all				0,31	0,31 * $V_{Rk} / 3,5$	1,5 * δV_0

Chemofast Injection System STVK Pro or STVK NORDIC Pro

Performances Hollow Clay brick MZ90-G with insulation
Group factors, characteristic Resistances and Displacements

Annex C 42

Brick type: Hollow light weight concrete brick HBL 16DF

Table C136: Stone description

Brick type	Hollow light weight concrete brick HBL 16DF		
Density	ρ [kg/dm ³]	$\geq 1,0$	
Compressive strength	f_b [N/mm ²]	$\geq 3,1$	
Conversion factor for lower compressive strengths	$(f_b / 3,1)^{0,5} \leq 1,0$		
Code	EN 771-3:2011+A1:2015		
Producer (Country)	e.g. KLB Klimaleichtblock (DE)		
Brick dimensions	[mm]	500 x 250 x 240	
Drilling method	Rotary drilling		

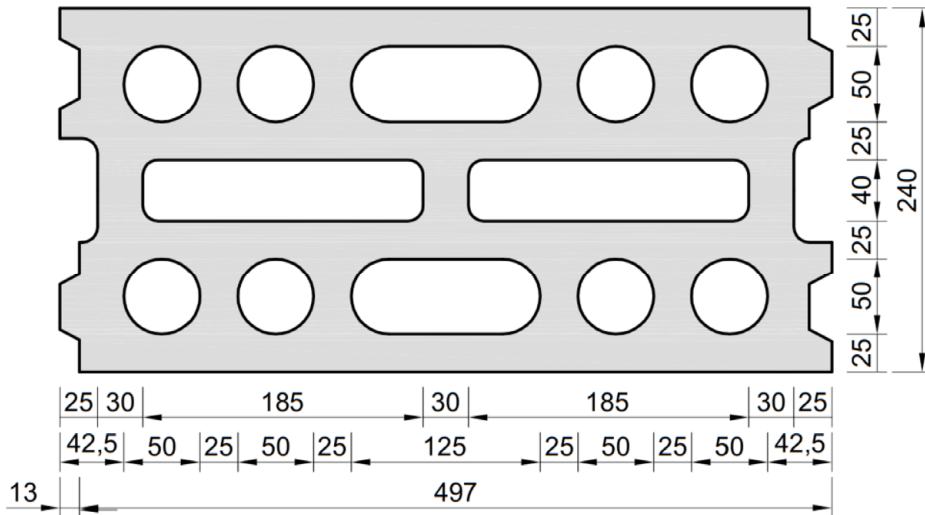
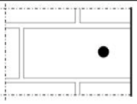
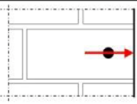
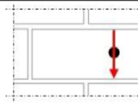

Table C137: Installation parameter

Anchor size		[-]	M8	M10	M12	M16	IG-M6	IG-M8	IG-M10
Installation torque	T_{inst}	[Nm]	≤ 2	≤ 2	≤ 5	≤ 5	≤ 2	≤ 5	≤ 5
Char. Edge distance	c_{cr}	[mm]	120 (for shear loads perpendicular to the free edge: $c_{cr} = 250$)						
Minimum Edge Distance	c_{min}	[mm]	50						
Characteristic Spacing	$s_{cr, II}$	[mm]	500						
	$s_{cr, \perp}$	[mm]	250						
Minimum Spacing	s_{min}	[mm]	50						

Table C138: Reduction factors for single anchors at the edge

Tension load			Shear load					
			Perpendicular to the free edge			Parallel to the free edge		
	with $c \geq$	$\alpha_{edge, N}$		with $c \geq$	$\alpha_{edge, V \perp}$		with $c \geq$	$\alpha_{edge, V II}$
	50	1,00		50	0,30		50	1,00
	120	1,00		250	1,00		120	1,00

Chemofast Injection System STVK Pro or STVK NORDIC Pro

Performances Hollow light weight concrete brick HBL 16DF
Description of the stone, Installation parameters, Reductionfactors

Annex C 43

Brick type: Hollow light weight concrete brick HBL 16DF

Table C139: Factors for anchor groups under tension load

Anchor position parallel to hor. joint				Anchor position perpendicular to hor. joint			
	with $c \geq$	with $s \geq$	$\alpha_{g II, N}$		with $c \geq$	with $s \geq$	$\alpha_{g \perp, N}$
	50	50	2,00		50	50	1,55
	120	500	2,00		120	250	2,00

Table C140: Factors for anchor groups under shear load

		Anchor position parallel to hor. joint			Anchor position perpendicular to hor. joint			
Shear load perpendicular to the free edge		with $c \geq$	with $s \geq$	$\alpha_{g II, V \perp}$		with $c \geq$	with $s \geq$	$\alpha_{g \perp, V \perp}$
		50	50	0,60		50	50	0,35
		120	50	2,00		120	50	1,15
Shear load parallel to the free edge		with $c \geq$	with $s \geq$	$\alpha_{g II, V \parallel}$		with $c \geq$	with $s \geq$	$\alpha_{g \perp, V \parallel}$
		50	50	1,30		50	50	1,00
		120	250	2,00		120	250	2,00

Table C141: Characteristic values of tension and shear load resistances

Anchor size	Perforated sleeve	Effective Anchorage depth	Characteristic Resistances with $c \geq c_{cr}$ and $s \geq s_{cr}$						
			Use condition						
			d/d			w/d w/w			d/d w/d w/w
			40°C/24°C	80°C/50°C	120°C/72°C	40°C/24°C	80°C/50°C	120°C/72°C	All Temperature ranges
		h_{ef}	$N_{Rk,b} = N_{Rk,p}$			$N_{Rk,b} = N_{Rk,p}$			$V_{Rk,b}^{2)}$
		[mm]	[kN]						
Compressive strength $f_b \geq 3,1 \text{ N/mm}^2$ ¹⁾									
M8 / M10/ IG-M6	16x85	85	1,2	1,2	0,9	1,2	1,2	0,9	2,0
	16x130	130							
M12 / IG-M8	20x85	85	1,5	1,5	1,2	1,5	1,5	1,2	3,0
	20x130	130							
	20x200	200							
M16 / IG-M10	20x85	85	1,5	1,5	1,2	1,5	1,5	1,2	5,0
	20x130	130							
	20x200	200							

¹⁾ For lower compressive strengths resistances must be multiplied by the conversion factor according to Table C136.

²⁾ $V_{Rk,c}$ according to Annex C3

Table C142: Displacements

Anchor size	h_{ef}	$\delta N / N$	δN_0	δN_{∞}	$\delta V / V$	δV_0	δV_{∞}
	[mm]	[mm/kN]	[mm]	[mm]	[mm/kN]	[mm]	[mm]
M8 – M12, IG-M6 – M10	all	0,13	0,13 * $N_{Rk} / 3,5$	2 * δN_0	0,55	0,55 * $V_{Rk} / 3,5$	1,5 * δV_0
M16	all				0,31	0,31 * $V_{Rk} / 3,5$	1,5 * δV_0

Chemofast Injection System STVK Pro or STVK NORDIC Pro

Performances Hollow light weight concrete brick HBL 16DF
Group factors, characteristic Resistances and Displacements

Annex C 44

Brick type: Hollow concrete brick Bloc Creux B40

Table C143: Stone description

Brick type	Hollow concrete brick Bloc Creux B40		
Density	ρ [kg/dm ³]	≥ 0,8	
Compressive strength	f_b [N/mm ²]	≥ 5,2	
Conversion factor for lower compressive strengths	$(f_b / 5,2)^{0,5} \leq 1,0$		
Code	EN 771-2:2011+A1:2015		
Producer (Country)	e.g. Leroux (FR)		
Brick dimensions	[mm]	500 x 200 x 200	
Drilling method	Rotary drilling		

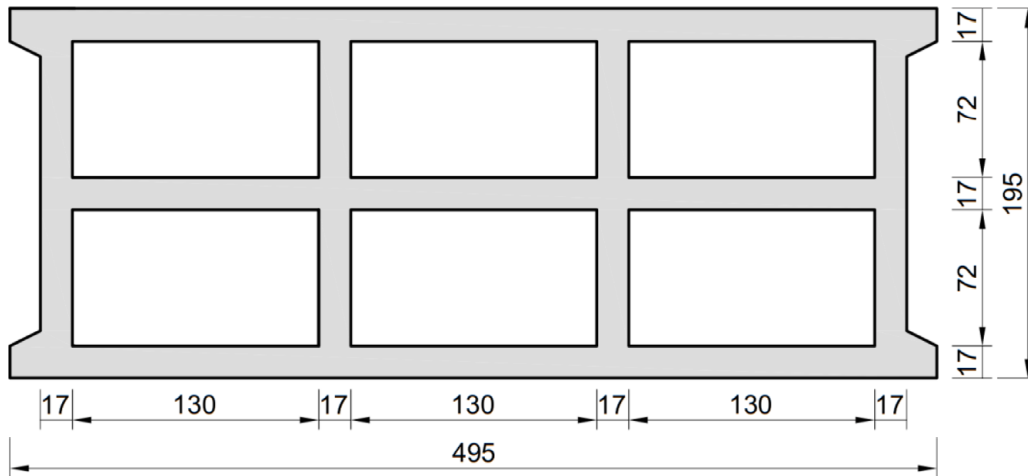
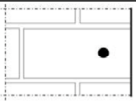
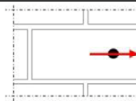
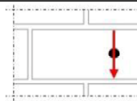

Table C144: Installation parameter

Anchor size		[-]	M8	M10	M12	M16	IG-M6	IG-M8	IG-M10
Installation torque	T_{inst}	[Nm]	≤ 4	≤ 4	≤ 4	≤ 4	≤ 4	≤ 4	≤ 4
Char. Edge distance	c_{cr}	[mm]	120 (for shear loads perpendicular to the free edge: $c_{cr} = 170$)						
Minimum Edge Distance	c_{min}	[mm]	50						
Characteristic Spacing	$s_{cr, II}$	[mm]	170						
	$s_{cr, \perp}$	[mm]	200						
Minimum Spacing	s_{min}	[mm]	50						

Table C145: Reduction factors for single anchors at the edge

Tension load			Shear load					
			Perpendicular to the free edge			Parallel to the free edge		
	with $c \geq$	$\alpha_{edge, N}$		with $c \geq$	$\alpha_{edge, V \perp}$		with $c \geq$	$\alpha_{edge, V II}$
	50	1,00		50	0,35		50	1,00
	120	1,00		170	1,00		120	1,00

Chemofast Injection System STVK Pro or STVK NORDIC Pro

Performances Hollow concrete brick Bloc Creux B40
Description of the stone, Installation parameters, Reduction factors

Annex C 45

Brick type: Hollow concrete brick Bloc Creux B40

Table C146: Factors for anchor groups under tension load

Anchor position parallel to hor. joint				Anchor position perpendicular to hor. joint			
	with $c \geq$	with $s \geq$	$\alpha_{g II, N}$		with $c \geq$	with $s \geq$	$\alpha_{g \perp, N}$
	50	50	1,50		50	50	1,40
	50	170	2,00		50	200	2,00
	120	170	2,00		120	200	2,00

Table C147: Factors for anchor groups under shear load

	Anchor position parallel to hor. joint				Anchor position perpendicular to hor. joint			
		with $c \geq$	with $s \geq$	$\alpha_{g II, V \perp}$		with $c \geq$	with $s \geq$	$\alpha_{g \perp, V \perp}$
Shear load perpendicular to the free edge		50	50	0,55		50	50	0,35
		120	50	1,30		120	50	0,85
		120	170	2,00		120	200	2,00
Shear load parallel to the free edge		50	50	1,10		50	50	1,00
		50	200	2,00		50	200	2,00
		120	170	2,00		120	200	2,00

Table C148: Characteristic values of tension and shear load resistances

Anchor size	Perforated sleeve	Effective Anchorage depth	Characteristic Resistances with $c \geq c_{cr}$ and $s \geq s_{cr}$						
			Use condition						
			d/d			w/d w/w			d/d w/d w/w
			40°C/24°C	80°C/50°C	120°C/72°C	40°C/24°C	80°C/50°C	120°C/72°C	All Temperature ranges
		h_{ef}	$N_{Rk,b} = N_{Rk,p}$			$N_{Rk,b} = N_{Rk,p}$			$V_{Rk,b}^{2)}$
		[mm]	[kN]						
Compressive strength $f_b \geq 5,2 \text{ N/mm}^2$ ¹⁾									
M8 / M10 / IG-M6	16x130	130							
M12 / IG-M8	20x130	130	2,0	1,5	1,2	2,0	1,5	1,2	6,0
M16 / IG-M10	20x130	130							

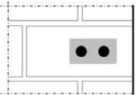
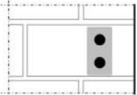
¹⁾ For lower compressive strengths resistances must be multiplied by the conversion factor according to Table C143.

²⁾ $V_{Rk,c}$ according to Annex C3

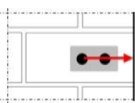
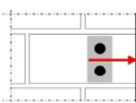
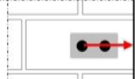
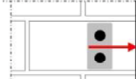
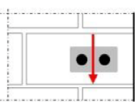
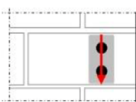
Table C149: Displacements

Anchor size	h_{ef}	$\delta N / N$	δN_0	δN_{∞}	$\delta v / V$	δv_0	δv_{∞}
	[mm]	[mm/kN]	[mm]	[mm]	[mm/kN]	[mm]	[mm]
M8 – M12, IG-M6 – M10	all	0,13	0,13 * $N_{Rk} / 3,5$	2 * δN_0	0,55	0,55 * $V_{Rk} / 3,5$	1,5 * δv_0
M16	all				0,31	0,31 * $V_{Rk} / 3,5$	1,5 * δv_0

Chemofast Injection System STVK Pro or STVK NORDIC Pro

Performances hollow concrete brick Bloc Creux B40
Group factors, characteristic Resistances and Displacements

Annex C 46

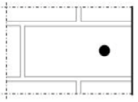
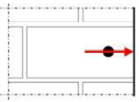
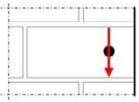
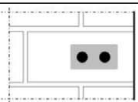
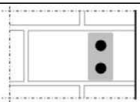
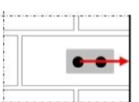
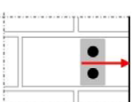
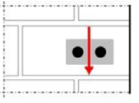
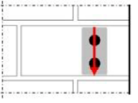
Brick type: Solid light weight concrete brick									
Table C150: Stone description									
Brick type	Solid light weight concrete brick								
Density	ρ [kg/dm ³]	$\geq 0,6$							
Compressive strength	f_b [N/mm ²]	≥ 2							
Conversion factor for lower compressive strengths	$(f_b / 2)^{0,5} \leq 1,0$								
Code	EN 771-3:2011+A1:2015								
Producer (Country)	e.g. Bisotherm (DE)								
Brick dimensions	[mm]	$\geq 240 \times 300 \times 113$							
Drilling method	Rotary drilling								
									
Table C151: Installation parameter									
Anchor size		[-]	M8	M10	M12	M16	IG-M6	IG-M8	IG-M10
Installation torque	T_{inst}	[Nm]	≤ 2	≤ 2	≤ 2	≤ 2	≤ 2	≤ 2	≤ 2
Char. Edge distance	c_{cr}	[mm]	150						
Minimum Edge Distance	c_{min}	[mm]	60						
Characteristic Spacing	$s_{cr, II}$	[mm]	300						
	$s_{cr, \perp}$	[mm]	300						
Minimum Spacing	s_{min}	[mm]	120						
Table C152: Reduction factors for single anchors at the edge									
Tension load			Shear load						
			Perpendicular to the free edge				Parallel to the free edge		
	with $c \geq$	$\alpha_{edge, N}$		with $c \geq$	$\alpha_{edge, V \perp}$		with $c \geq$	$\alpha_{edge, V II}$	
	60	1,00		60	0,25		60	0,40	
	150	1,00		150	1,00		100	1,00	
Table C153: Factors for anchor groups under tension load									
Anchor position parallel to hor. joint				Anchor position perpendicular to hor. joint					
	with $c \geq$	with $s \geq$	$\alpha_{g II, N}$		with $c \geq$	with $s \geq$	$\alpha_{g \perp, N}$		
	60	120	1,00		60	120	1,00		
	150	300	2,00		150	300	2,00		
Table C154: Factors for anchor groups under shear load									
Anchor position parallel to hor. joint				Anchor position perpendicular to hor. joint					
Shear load perpendicular to the free edge		with $c \geq$	with $s \geq$	$\alpha_{g II, V \perp}$		with $c \geq$	with $s \geq$	$\alpha_{g \perp, V \perp}$	
		60	120	0,25		60	120	0,25	
		150	120	1,00		150	120	1,00	
Shear load parallel to the free edge		with $c \geq$	with $s \geq$	$\alpha_{g II, V II}$		with $c \geq$	with $s \geq$	$\alpha_{g \perp, V II}$	
		60	120	0,40		60	120	0,40	
		100	120	1,00		100	120	1,00	
	150	300	2,00		150	300	2,00		
Chemofast Injection System STVK Pro or STVK NORDIC Pro							Annex C 47		
Performances Solid light weight concrete brick Description of the stone, Installation parameters, Reduction- and Group factors									

Brick type: Solid light weight concrete brick									
Table C155: Characteristic values of tension and shear load resistances									
Anchor size	Perforated sleeve	Effective Anchorage depth	Characteristic Resistances with $c \geq c_{cr}$ and $s \geq s_{cr}$						
			Use condition						
			d/d			w/d w/w			d/d w/d w/w
			40°C/24°C	80°C/50°C	120°C/72°C	40°C/24°C	80°C/50°C	120°C/72°C	All Temperature ranges
h_{ef}	$N_{Rk,b} = N_{Rk,p}$			$N_{Rk,b} = N_{Rk,p}$			$V_{Rk,b}^{2)}$		
[mm]	[kN]								
Compressive strength $f_b \geq 2 \text{ N/mm}^2$ ¹⁾									
M8	-	80	3,0	2,5	2,0	2,5	2,0	1,5	3,0
M10 / IG-M6	-	90							
M12 / IG-M8	-	100							
M16 / IG-M10	-	100							
M8	12x80	80	2,5	2,5	2,0	2,5	2,0	1,5	
M8 / M10/ IG-M6	16x85	85							
	16x130	130							
M12 / IG-M8	20x85	85							
	20x130	130							
	20x200	200							
M16 / IG-M10	20x85	85							
	20x130	130							
	20x200	200							

¹⁾ For lower compressive strengths resistances must be multiplied by the conversion factor according to Table C150.
²⁾ $V_{Rk,c}$ according to Annex C3

Table C156: Displacements							
Anchor size	h_{ef}	$\delta N / N$	δN_0	δN_{∞}	$\delta V / V$	δV_0	δV_{∞}
	[mm]	[mm/kN]	[mm]	[mm]	[mm/kN]	[mm]	[mm]
M8 – M12, IG-M6 – M10	all	0,1	0,1 * $N_{Rk} / 3,5$	2 * δN_0	0,3	0,3 * $V_{Rk} / 3,5$	1,5 * δV_0
M16	all				0,1	0,1 * $V_{Rk} / 3,5$	1,5 * δV_0

Chemofast Injection System STVK Pro or STVK NORDIC Pro	Annex C 48
Performances Solid light weight concrete brick Characteristic Resistances and Displacements	