

Approval body for construction products  
and types of construction

Bautechnisches Prüfamt

An institution established by the Federal and  
Laender Governments



## European Technical Assessment

ETA-09/0211  
of 18 May 2021

English translation prepared by DIBt - Original version in German language

### General Part

Technical Assessment Body issuing the  
European Technical Assessment:

Deutsches Institut für Bautechnik

Trade name of the construction product

CELO Bonded anchor VA

Product family  
to which the construction product belongs

Bonded fastener for use in concrete

Manufacturer

CELO Befestigungssysteme GmbH  
Industriestraße 6  
86551 Aichach  
DEUTSCHLAND

Manufacturing plant

Werk 6

This European Technical Assessment  
contains

11 pages including 3 annexes which form an integral part  
of this assessment

This European Technical Assessment is  
issued in accordance with Regulation (EU)  
No 305/2011, on the basis of

EAD 330499-01-0601, Edition 4/2020

This version replaces

ETA-09/0211 issued on 10 July 2018

The European Technical Assessment is issued by the Technical Assessment Body in its official language. Translations of this European Technical Assessment in other languages shall fully correspond to the original issued document and shall be identified as such.

Communication of this European Technical Assessment, including transmission by electronic means, shall be in full. However, partial reproduction may only be made with the written consent of the issuing Technical Assessment Body. Any partial reproduction shall be identified as such.

This European Technical Assessment may be withdrawn by the issuing Technical Assessment Body, in particular pursuant to information by the Commission in accordance with Article 25(3) of Regulation (EU) No 305/2011.

## Specific Part

### 1 Technical description of the product

The CELO bonded anchor VA is a bonded anchor consisting of a mortar capsule and a steel element according to Annex A.

The steel element is anchored via the bond between metal part, injection mortar and concrete.

The product description is given in Annex A.

### 2 Specification of the intended use in accordance with the applicable European Assessment Document

The performances given in Section 3 are only valid if the anchor is used in compliance with the specifications and conditions given in Annex B.

The verifications and assessment methods on which this European Technical Assessment is based lead to the assumption of a working life of the anchor of at least 50 years. The indications given on the working life cannot be interpreted as a guarantee given by the producer, but are to be regarded only as a means for choosing the right products in relation to the expected economically reasonable working life of the works.

### 3 Performance of the product and references to the methods used for its assessment

#### 3.1 Mechanical resistance and stability (BWR 1)

Essential characteristic	Performance
Characteristic resistance to tension load (static and quasi-static loading)	See Annex B 2, C 1
Characteristic resistance to shear load (static and quasi-static loading)	See Annex C 2
Displacements under short-term and long-term loading	See Annex C 2
Characteristic resistance and displacements for seismic performance categories C1 and C2	No performance assessed

#### 3.2 Hygiene, health and the environment (BWR 3)

Essential characteristic	Performance
Content, emission and/or release of dangerous substances	No performance assessed

English translation prepared by DIBt

**4 Assessment and verification of constancy of performance (AVCP) system applied, with reference to its legal base**

In accordance with the European Assessment Document EAD 330499-01-0601 the applicable European legal act is: [96/582/EC].

The system to be applied is: 1

**5 Technical details necessary for the implementation of the AVCP system, as provided for in the applicable European Assessment Document**

Technical details necessary for the implementation of the AVCP system are laid down in the control plan deposited at Deutsches Institut für Bautechnik.

Issued in Berlin on 18 May 2021 by Deutsches Institut für Bautechnik

Dipl.-Ing. Beatrix Wittstock  
Head of Section

*beglaubigt:*  
Baderschneider

### Installed fastener

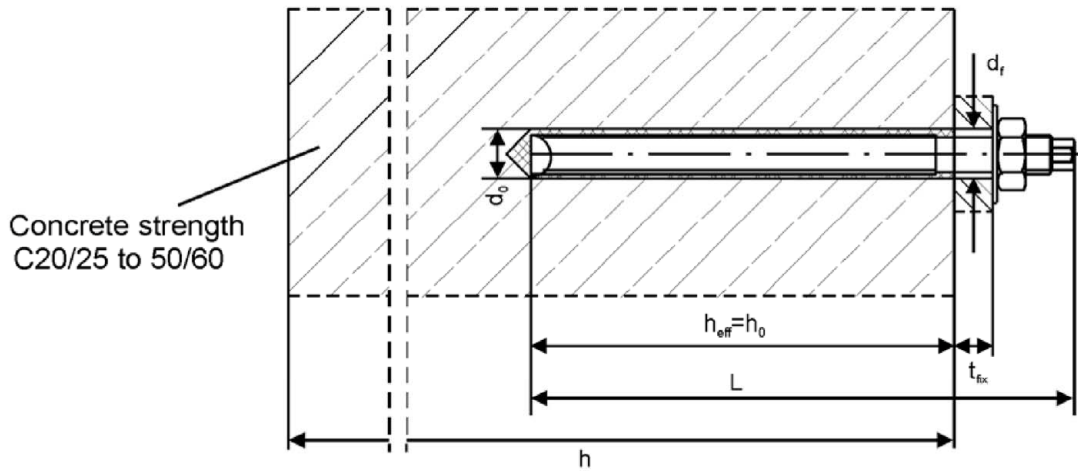

### Mortar Capsule

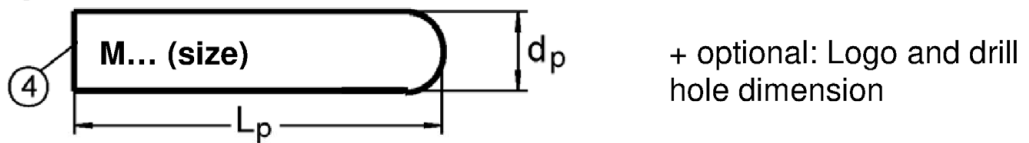

### Threaded rod for VA

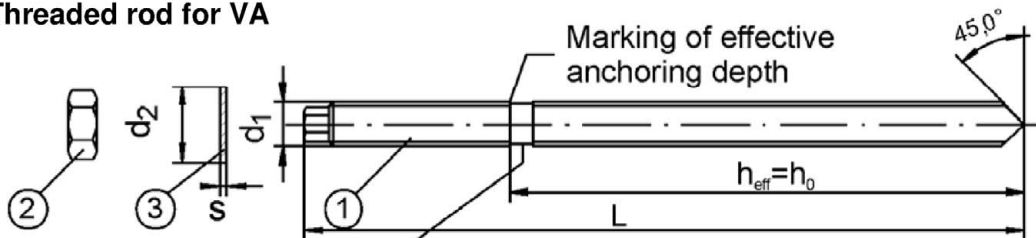

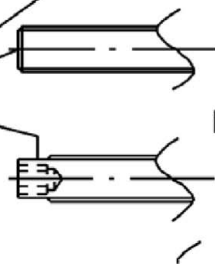

### Marking 1

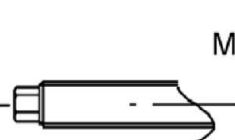

Marking 1: Identifying mark of manufacturing plant, e.g. "K"  
Size of thread M...  
Example KM10, for stainless steel plus E,  
for high corrosion plus H

### Marking 2



Marking 2: Example: , for stainless steel plus E,  
for high corrosion plus H

For anchor rods without marking of the effective embedment depth, this must be marked before the installation.

### CELO Bonded anchor VA

#### Product description

Installed condition  
Mortar Capsule, Threaded rod

Annex A 1

**Table A1: Dimensions**

Anchor size			M8	M10	M12	M16	M20	M24
Threaded rod	Ø d <sub>1</sub>	[mm]	M8	M10	M12	M16	M20	M24
	L ≥	[mm]	90	100	120	140	190	235
	h <sub>ef</sub>	[mm]	80	90	110	125	170	210
Mortar Capsule	d <sub>p</sub>	[mm]	9	10,5	12,5	16,5	23	23
	L <sub>p</sub>	[mm]	80	85	95	95	160	190

**Table A2: Materials**

Part	Designation	Material	
		Steel, zinc plated ≥ 5 µm acc. to EN ISO 4042:2018	Steel, hot-dip galvanized ≥ 40 µm acc. to EN ISO 1461:2009
1	Threaded rod	Steel EN 10087:2019, EN 10263:2017 Property class 5.8, acc. to EN ISO 898-1:2013	
2	Hexagon nut EN ISO 4032:2012	Steel Property class 8, acc. to EN ISO 898-2:2012	
3	Washer EN ISO 7089:2000 EN ISO 7093:2000 EN ISO 7094:2000	Steel, galvanized	Steel, hot-dip galvanized
Part	Designation	Material	
		Stainless steel A4	High corrosion resistant steel (HCR)
1	Threaded rod	Material 1.4401, 1.4404, 1.4571, 1.4578, EN 10088:2014, Property class 70, EN ISO 3506-1:2009	Material 1.4529, 1.4565, EN 10088:2014, Property class 70, EN ISO 3506-1:2009
2	Hexagon nut EN ISO 4032:2012	Material, 1.4401, 1.4404, 1.4571, EN 10088-1:2014, Property class 70, EN ISO 3506-2:2009	Material 1.4529, 1.4565, EN 10088-1:2014, Property class 70, EN ISO 3506-2:2009
3	Washer EN ISO 7089:2000 EN ISO 7093:2000 EN ISO 7094:2000	Material, 1.4401, 1.4404, 1.4571, EN 10088-1:2014	Material 1.4529, 1.4565, EN 10088-1:2014
Part	Designation	Material	
4	Mortar capsule	Glass, Quartz, Resin, Hardener	

**CELO Bonded anchor VA**

**Product description**  
Dimensions and Materials

**Annex A 2**

## Specifications of intended use

### Anchorage subject to:

- Static and quasi-static loads.

### Base materials:

- Compacted, reinforced or unreinforced normal weight concrete without fibres according to EN 206:2013 + A1:2016.
- Strength classes C20/25 to C50/60 according to EN 206:2013 + A1:2016.
- Uncracked concrete.

### Temperature Range:

- -40°C to 80°C (max long term temperature +50 °C and max short term temperature +80 °C)

### Use conditions (Environmental conditions):

- Structures subject to dry internal conditions (all materials).
- For all other conditions according to EN 1993-1-4:2006+A1:2015 corresponding to corrosion resistance class:
  - Stainless steel Stahl A4 according to Annex A 2, Table A2: CRC III
  - High corrosion resistance steel HCR according to Annex A 2, Table A2: CRC V

### Design:

- Anchorages are designed under the responsibility of an engineer experienced in anchorages and concrete work.
- Verifiable calculation notes and drawings are prepared taking account of the loads to be anchored. The position of the anchor is indicated on the design drawings (e. g. position of the anchor relative to reinforcement or to supports, etc.).
- The anchorages are designed in accordance to EN 1992-4:2018 and Technical Report TR 055, Edition February 2018

### Installation:

- Dry or wet concrete: all sizes.
- Flooded holes (not sea water): M12 to M24.
- Hole drilling by hammer drilling.
- Anchor installation carried out by appropriately qualified personnel and under the supervision of the person responsible for technical matters of the site.
- The mortar capsule is placed into the drilled hole; connecting the anchor rod with the percussion drill by using a corresponding adapter; driving the anchor rod into the mortar capsule by simultaneous hammering and turning of the drill; if the anchorage depth is achieved the drill must stopped immediately by using some pressure; if the anchor is proper installed mortar must be visible at the member surface

**CELO Bonded anchor VA**

**Intended Use**  
Specifications

**Annex B 1**

**Table B1: Installation parameters**

Fastener size			M8	M10	M12	M16	M20	M24
Nominal diameter of drill hole	$d_0$	[mm]	10	12	14	18	25	28
Max. cutting diameter of drill hole	$d_{cut}$	[mm]	10,45	12,45	14,5	18,5	25,5	28,5
Depth of drill hole	$h_0$	[mm]	80	90	110	125	170	210
Effective embedment depth	$h_{eff}$	[mm]	80	90	110	125	170	210
Diameter of clearance hole in fixture	$d_{f \leq}$	[mm]	9	12	14	18	22	26
Max. torque moment	max. $T_{inst}$	[Nm]	10	20	40	60	120	150
Minimum member thickness	$h_{min}$	[mm]	110	120	150	160	220	300
Minimum edge distance	$c_{min}$	[mm]	60	70	85	95	130	160
Minimum spacing	$s_{min}$	[mm]	60	70	85	95	130	160

## Cleaning Tools

### Steel Brush RBS



Fastener Size			M8	M10	M12	M16	M20	M24
Diameter of steel brush	d	[mm]	12	14	16	20	27	30

### Blow Pump AB (Standard Cleaning)



### Compressed Air (Premium Cleaning)

Oilfree compressed air with a pressure  $\geq 6$  bar

**Table B2: Minimum curing time**

Temperature in the anchorage base	Minimum curing time in dry concrete [min]	Minimum curing time in wet concrete [min]
0°C to 5°C	180	360
5°C to 10°C	90	180
10°C to 20°C	40	80
> 20°C	20	40

## CELO Bonded anchor VA

### Intended Use

Installation parameters, Cleaning and Setting Tools, Minimum curing time

## Annex B 2



## Installation instructions

### Standard Cleaning

- Drill the hole.  
Blow out the dust with the blow pump AB twice.
- Brush the drill hole twice with the steel brush RBS  
again blow out the dust with the blow pump AB twice.
- Check the capsule before using. The capsule can be used  
if it is undamaged and the resin is viscous. Insert the capsule  
into the drill hole.
- Drive the anchor stud into the drill hole with the help of a  
percussion drill. Notice the curing times. In case of a wet base  
material the curing time has to be doubled.
- Respect the curing time, afterwards the nut can be tightened  
(see table "minimum curing time").  
Note the max. installation torque.

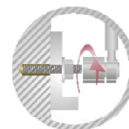
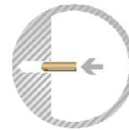
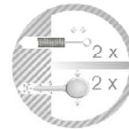

### Premium Cleaning

- Drill the hole.  
Blow out the dust with compressed air (>6 bar) twice
- brush the drill hole twice with steel brush RBS  
Again blow out dust with compressed air (>6 bar) twice.
- Check the capsule before using. The capsule can be used  
if it is undamaged and the resin is viscous. Insert the capsule  
into the drill hole.
- Drive the anchor stud into the drill hole with the help of a  
percussion drill. Notice the curing times .In case of a wet base  
material the curing time has to be doubled.
- Respect the curing time, afterwards the nut can be tightened  
(see table "minimum curing time").  
Note the max. installation torque.

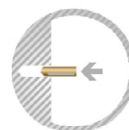

For all installations the max setting time of 10 seconds should not be exceeded.

**CELO Bonded anchor VA**

**Intended Use**  
Installation instructions

**Annex B 3**

**Table C1: Characteristic values of resistance under tension loads**

Fastener size			M8	M10	M12	M16	M20	M24
<b>Steel failure</b>								
Characteristic resistance, Steel property class 5.8	$N_{Rk,s}$	[kN]	17	26	38	72	114	165
Partial factor	$\gamma_{Ms,N}$	[-]	1,56					
Characteristic resistance, Stainless steel (class 70)	$N_{Rk,s}$	[kN]	23	34	52	97	153	222
Partial factor	$\gamma_{Ms,N}$	[-]	1,87					
<b>Combined pull-out and concrete cone failure</b>								
Installation factor for dry and wet concrete	$\gamma_{inst}$	[-]	1,2					
Installation factor for flooded holes	$\gamma_{inst}$	[-]	-1)			1,2		
Characteristic bond resistance in uncracked concrete, max. temperature 50/80°C Standard Cleaning	$\tau_{Rk,ucr}$	[N/mm <sup>2</sup> ]	4,5	4,0	4,0	4,0	3,5	3,5
Characteristic bond resistance in uncracked concrete max. temperature 50/80°C Premium Cleaning	$\tau_{Rk,ucr}$	[N/mm <sup>2</sup> ]	6,0	5,5	6,0	5,5	5,5	4,5
Characteristic bond resistance in cracked concrete	$\tau_{Rk,cr}$	[N/mm <sup>2</sup> ]	No performance assessed					
Increasing factors $\psi_c$ for concrete	C30/37		1,08					
	C40/50		1,15					
	C50/60		1,19					
Reduction Factor	$\psi^0_{sus}$	[-]	No performance assessed					
<b>Concrete cone failure</b>								
Factor for uncracked concrete	$k_{ucr}$	[-]	11,0					
Factor for cracked concrete	$k_{cr}$	[-]	No performance assessed					
Edge distance	$c_{cr,N}$	[mm]	1,5* $h_{ef}$					
Spacing	$s_{cr,N}$	[mm]	2* $c_{cr,N}$					
<b>Splitting failure</b>								
Edge distance	$c_{cr,Sp}$	[mm]	120	135	165	190	255	315
Spacing	$s_{cr,Sp}$	[mm]	240	270	330	380	510	630

<sup>1)</sup> No performance assessed

**Table C2: Displacements under tension loads**

Fastener size			M8	M10	M12	M16	M20	M24
Displacement	$\delta_{N0}$	[mm]	0,1	0,1	0,1	0,2	0,3	0,3
Displacement	$\delta_{N\infty}$	[mm]	1,1	1,1	1,1	2,2	3,3	3,3

**CELO Bonded anchor VA**

**Performances**

Characteristic values of resistance under tension loads, Displacements under tension loads

**Annex C 1**

**Table C3: Characteristic values of resistance under shear loads**

Fastener size			M8	M10	M12	M16	M20	M24
<b>Steel failure without lever arm</b>								
Characteristic resistance, Steel property class 5.8	$V_{Rk,s}^0$	[kN]	8	13	19	36	57	83
Partial factor	$\gamma_{Ms,V}$	[-]	1,25					
Characteristic resistance, Stainless steel (class 70)	$V_{Rk,s}^0$	[kN]	11	17	26	49	77	111
Partial factor	$\gamma_{Ms,V}$	[-]	1,56					
Ductility factor	$k_7$	[-]	1,0					
<b>Steel failure with lever arm</b>								
Characteristic bending moment, Steel property class 5.8	$M_{Rk,s}^0$	[Nm]	16	30	56	144	285	498
Partial factor	$\gamma_{Ms,V}$	[-]	1,25					
Characteristic bending moment, Steel property class 70	$M_{Rk,s}^0$	[Nm]	22	41	75	194	384	670
Partial factor	$\gamma_{Ms,V}$	[-]	1,56					
Ductility factor	$k_7$	[-]	1,0					
<b>Concrete pry-out failure</b>								
Pry-out factor	$k_8$	[-]	2,0					
<b>Concrete edge failure</b>								
Effective length of anchor in shear loading	$l_f$	[mm]	80	90	110	125	170	210
Outside diameter of anchor	$d_{nom}$	[mm]	10	12	14	18	25	28
Installation factor	$\gamma_{inst}$	[-]	1,0					

**Table C4: Displacements under shear loads**

Fastener size			M8	M10	M12	M16	M20	M24
Displacement	$\delta_{v0}$	[mm]	1,5	1,6	1,8	2,0	2,5	3,0
Displacement	$\delta_{v\infty}$	[mm]	2,3	2,4	2,7	3,0	3,8	4,5

**CELO Bonded anchor VA**

**Performances**

Characteristic values of resistance under shear loads, Displacements under shear loads

**Annex C 2**