

Approval body for construction products  
and types of construction

Bautechnisches Prüfamt

An institution established by the Federal and  
Laender Governments



## European Technical Assessment

**ETA-16/0107**  
**of 27 January 2021**

English translation prepared by DIBt - Original version in German language

### General Part

Technical Assessment Body issuing the  
European Technical Assessment:

Deutsches Institut für Bautechnik

Trade name of the construction product

EJOT Chemical Anchor MULTIFIX USF,  
MULTIFIX USF winter for concrete

Product family  
to which the construction product belongs

Bonded anchor for use in concrete

Manufacturer

EJOT Baubefestigungen GmbH  
In der Stockwiese 35  
57334 Bad Laasphe  
DEUTSCHLAND

Manufacturing plant

EJOT Herstellwerk 24

This European Technical Assessment  
contains

28 pages including 3 annexes which form an integral part  
of this assessment

This European Technical Assessment is  
issued in accordance with Regulation (EU)  
No 305/2011, on the basis of

EAD 330499-01-0601, Edition 04/2020

This version replaces

ETA-16/0107 issued on 22 March 2016

The European Technical Assessment is issued by the Technical Assessment Body in its official language. Translations of this European Technical Assessment in other languages shall fully correspond to the original issued document and shall be identified as such.

Communication of this European Technical Assessment, including transmission by electronic means, shall be in full. However, partial reproduction may only be made with the written consent of the issuing Technical Assessment Body. Any partial reproduction shall be identified as such.

This European Technical Assessment may be withdrawn by the issuing Technical Assessment Body, in particular pursuant to information by the Commission in accordance with Article 25(3) of Regulation (EU) No 305/2011.

## Specific Part

### 1 Technical description of the product

The "EJOT Chemical Anchor MULTIFIX USF, MULTIFIX USF winter for concrete" is a bonded anchor consisting of a cartridge with injection mortar Multifix USF or Multifix USF Winter and a steel element. The steel element consists of a commercial threaded rod with washer and hexagon nut in the range of M8 to M30 or reinforcing bar in the range of Ø 8 to Ø 32 mm or an internal threaded anchor rod IG-M6 to IG-M20.

The steel element is placed into a drilled hole filled with injection mortar and is anchored via the bond between metal part, injection mortar and concrete.

The product description is given in Annex A.

### 2 Specification of the intended use in accordance with the applicable European Assessment Document

The performances given in Section 3 are only valid if the anchor is used in compliance with the specifications and conditions given in Annex B.

The verifications and assessment methods on which this European Technical Assessment is based lead to the assumption of a working life of the anchor of at least 50 years. The indications given on the working life cannot be interpreted as a guarantee given by the producer, but are to be regarded only as a means for choosing the right products in relation to the expected economically reasonable working life of the works.

### 3 Performance of the product and references to the methods used for its assessment

#### 3.1 Mechanical resistance and stability (BWR 1)

Essential characteristic	Performance
Characteristic resistance to tension load (static and quasi-static loading)	See Annex C 1 to C 3, C 5, C 7
Characteristic resistance to shear load (static and quasi-static loading)	See Annex C1, C 4, C 6, C 8
Displacements (static and quasi-static loading)	See Annex C 9 to C 11
Characteristic resistance and displacements for seismic performance categories C1	See Annex C 12 to C 16
Characteristic resistance and displacements for seismic performance categories C2	No performance assessed

#### 3.2 Hygiene, health and the environment (BWR 3)

Essential characteristic	Performance
Content, emission and/or release of dangerous substances	No performance assessed

English translation prepared by DIBt

**4 Assessment and verification of constancy of performance (AVCP) system applied, with reference to its legal base**

In accordance with the European Assessment Document EAD 330499-01-0601 the applicable European legal act is: [96/582/EC].

The system to be applied is: 1

**5 Technical details necessary for the implementation of the AVCP system, as provided for in the applicable European Assessment Document**

Technical details necessary for the implementation of the AVCP system are laid down in the control plan deposited at Deutsches Institut für Bautechnik.

Issued in Berlin on 27 January 2021 by Deutsches Institut für Bautechnik

Dipl.-Ing. Beatrix Wittstock  
Head of Section

*beglaubigt:*  
Baderschneider

### Installation threaded rod M8 up to M30

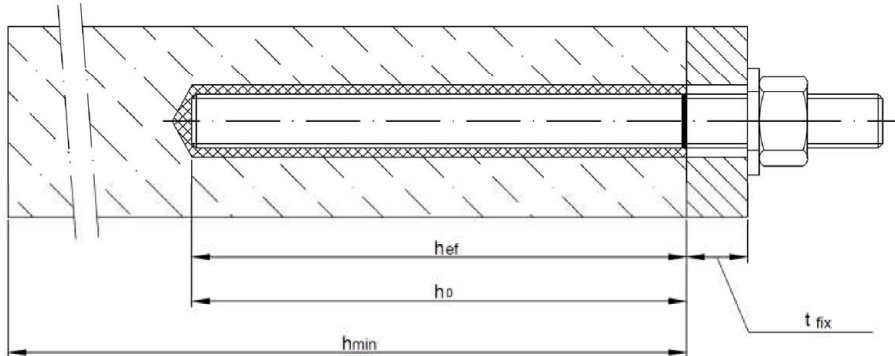

### Installation reinforcing bar $\varnothing 8$ up to $\varnothing 32$

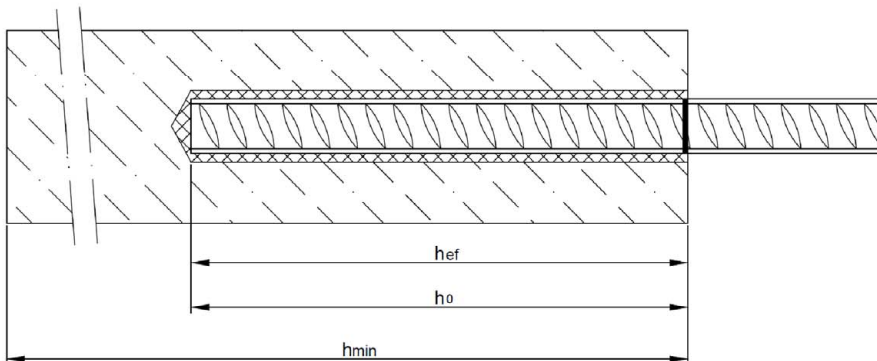

### Installation internal threaded anchor rod IG-M6 up to IG-M20

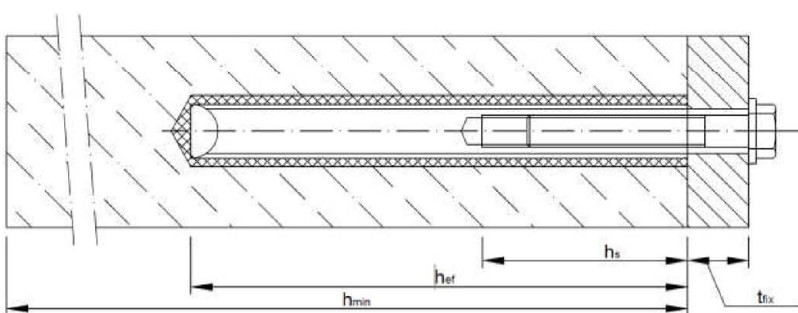

- $t_{fix}$  = thickness of fixture
- $h_{ef}$  = effective anchorage depth
- $h_0$  = depth of drill hole
- $h_{min}$  = minimum thickness of member

EJOT Chemical Anchor MULTIFIX USF, MULTIFIX USF winter for concrete

**Product description**  
Installed condition

**Annex A 1**

**Cartridge: Multifix USF or Multifix USF Winter**

**150 ml, 280 ml, 300 ml up to 333 ml and 380 ml up to 420 ml cartridge (Type: coaxial)**

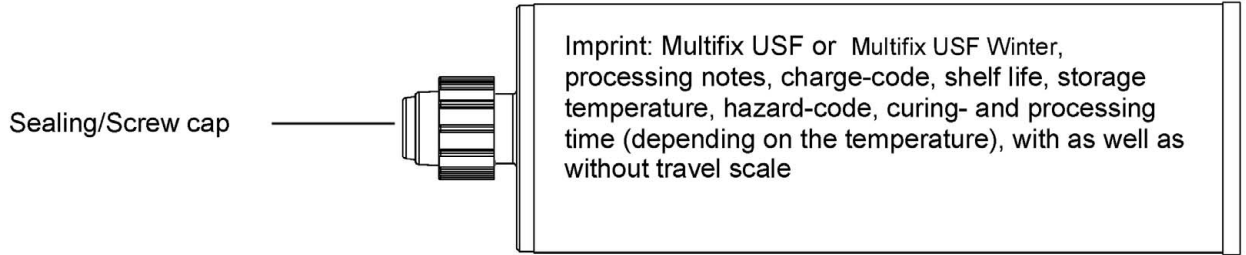

**235 ml, 345 ml up to 360 ml and 825 ml cartridge (Type: "side-by-side")**

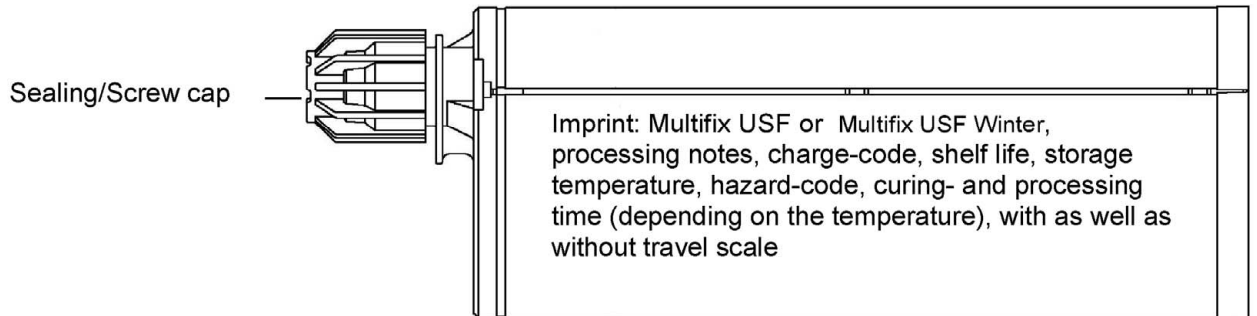

**165 ml and 300 ml cartridge (Type: "foil tube")**

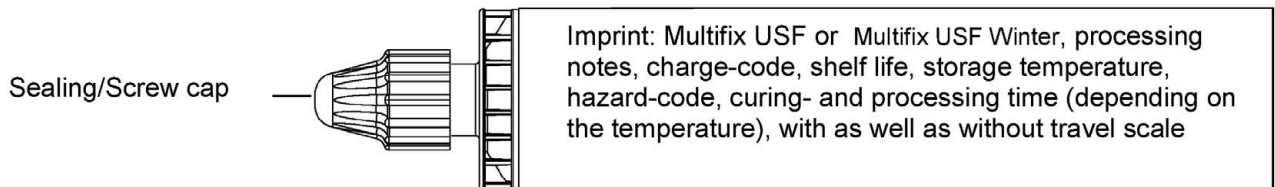

**Static Mixer**

CRW 14W

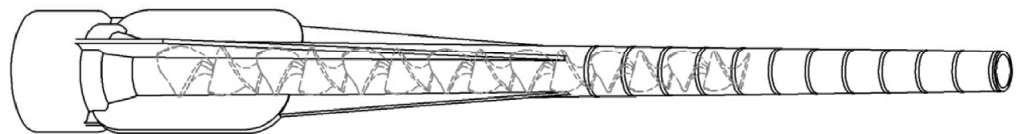

TAH 18W

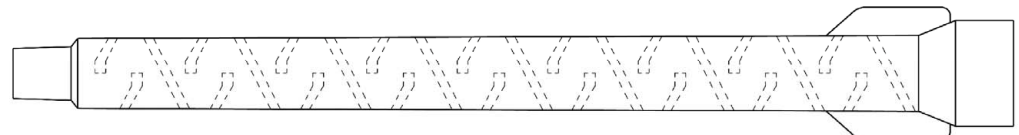

**EJOT Chemical Anchor MULTIFIX USF, MULTIFIX USF winter for concrete**

**Product description**  
Injection system

**Annex A 2**

**Threaded rod M8, M10, M12, M16, M20, M24, M27, M30 with washer and hexagon nut**

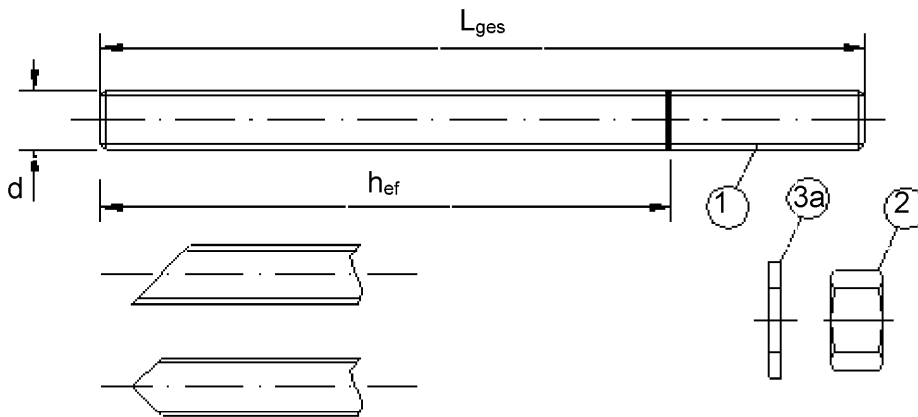



- Commercial standard threaded rod with:
- Materials, dimensions and mechanical properties acc. Table A1
  - Inspection certificate 3.1 acc. to EN 10204:2004
  - Marking of embedment depth

**Internal threaded anchor rod IG-M6, IG-M8, IG-M10, IG-M12, IG-M16, IG-M20**

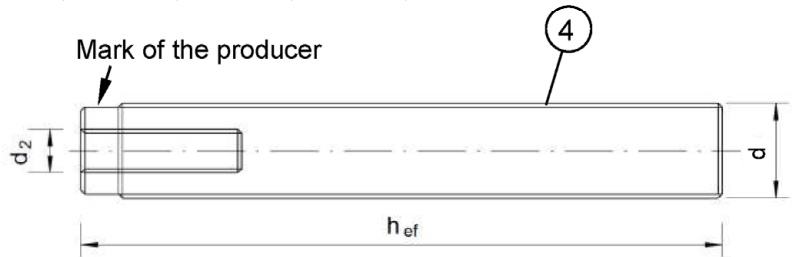
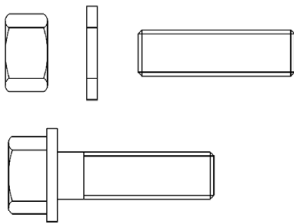
Threaded rod or screw



Marking: e.g.  M8

-  Marking Internal thread
-  Mark

- M8 Thread size (Internal thread)
- A4 additional mark for stainless steel
- HCR additional mark for high-corrosion resistance steel

**Filling washer and mixer reduction nozzle for filling the annular gap between anchor rod and fixture**

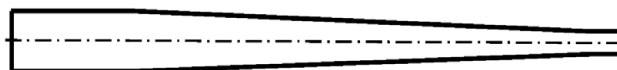
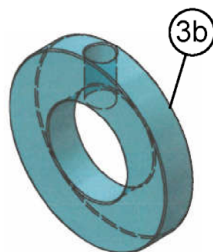

**EJOT Chemical Anchor MULTIFIX USF, MULTIFIX USF winter for concrete**

**Product description**  
Threaded rod, internal threaded rod and filling washer

**Annex A 3**

Table A1: Materials						
Part	Designation	Material				
<b>Steel, zinc plated</b> (Steel acc. to EN 10087:1998 or EN 10263:2001)						
- zinc plated $\geq 5 \mu\text{m}$ acc. to EN ISO 4042:1999 or						
- hot-dip galvanised $\geq 40 \mu\text{m}$ acc. to EN ISO 1461:2009 and EN ISO 10684:2004+AC:2009 or						
- sherardized $\geq 45 \mu\text{m}$ acc. to EN ISO 17668:2016						
1	Threaded rod	Property class	Characteristic tensile strength	Characteristic yield strength	Elongation at fracture	
		acc. to EN ISO 898-1:2013	4.6	$f_{uk} = 400 \text{ N/mm}^2$	$f_{yk} = 240 \text{ N/mm}^2$	$A_5 > 8\%$
			4.8	$f_{uk} = 400 \text{ N/mm}^2$	$f_{yk} = 320 \text{ N/mm}^2$	$A_5 > 8\%$
			5.6	$f_{uk} = 500 \text{ N/mm}^2$	$f_{yk} = 300 \text{ N/mm}^2$	$A_5 > 8\%$
			5.8	$f_{uk} = 500 \text{ N/mm}^2$	$f_{yk} = 400 \text{ N/mm}^2$	$A_5 > 8\%$
8.8	$f_{uk} = 800 \text{ N/mm}^2$	$f_{yk} = 640 \text{ N/mm}^2$	$A_5 \geq 8\%$			
2	Hexagon nut	acc. to EN ISO 898-2:2012	4	for threaded rod class 4.6 or 4.8		
			5	for threaded rod class 5.6 or 5.8		
			8	for threaded rod class 8.8		
3a	Washer	Steel, zinc plated, hot-dip galvanised or sherardized (e.g.: EN ISO 887:2006, EN ISO 7089:2000, EN ISO 7093:2000 or EN ISO 7094:2000)				
3b	Filling washer	Steel, zinc plated, hot-dip galvanised or sherardized				
4	Internal threaded anchor rod	Property class	Characteristic tensile strength	Characteristic yield strength	Elongation at fracture	
		acc. to EN ISO 898-1:2013	5.8	$f_{uk} = 500 \text{ N/mm}^2$	$f_{yk} = 400 \text{ N/mm}^2$	$A_5 > 8\%$
			8.8	$f_{uk} = 800 \text{ N/mm}^2$	$f_{yk} = 640 \text{ N/mm}^2$	$A_5 > 8\%$
<b>Stainless steel A2</b> (Material 1.4301 / 1.4307 / 1.4311 / 1.4567 or 1.4541, acc. to EN 10088-1:2014)						
<b>Stainless steel A4</b> (Material 1.4401 / 1.4404 / 1.4571 / 1.4362 or 1.4578, acc. to EN 10088-1:2014)						
<b>High corrosion resistance steel</b> (Material 1.4529 or 1.4565, acc. to EN 10088-1: 2014)						
1	Threaded rod <sup>1)3)</sup>	Property class	Characteristic tensile strength	Characteristic yield strength	Elongation at fracture	
		acc. to EN ISO 3506-1:2009	50	$f_{uk} = 500 \text{ N/mm}^2$	$f_{yk} = 210 \text{ N/mm}^2$	$A_5 \geq 8\%$
			70	$f_{uk} = 700 \text{ N/mm}^2$	$f_{yk} = 450 \text{ N/mm}^2$	$A_5 \geq 8\%$
80	$f_{uk} = 800 \text{ N/mm}^2$	$f_{yk} = 600 \text{ N/mm}^2$	$A_5 \geq 8\%$			
2	Hexagon nut <sup>1)3)</sup>	acc. to EN ISO 3506-1:2009	50	for threaded rod class 50		
			70	for threaded rod class 70		
			80	for threaded rod class 80		
3a	Washer	A2: Material 1.4301 / 1.4307 / 1.4311 / 1.4567 or 1.4541, acc. to EN 10088-1:2014 A4: Material 1.4401 / 1.4404 / 1.4571 / 1.4362 or 1.4578, acc. to EN 10088-1:2014 HCR: Material 1.4529 or 1.4565, acc. to EN 10088-1: 2014 (e.g.: EN ISO 887:2006, EN ISO 7089:2000, EN ISO 7093:2000 or EN ISO 7094:2000)				
3b	Filling washer	Stainless steel A4, High corrosion resistance steel				
4	Internal threaded anchor rod <sup>1)2)</sup>	Property class	Characteristic tensile strength	Characteristic yield strength	Elongation at fracture	
		acc. to EN ISO 3506-1:2009	50	$f_{uk} = 500 \text{ N/mm}^2$	$f_{yk} = 210 \text{ N/mm}^2$	$A_5 > 8\%$
			70	$f_{uk} = 700 \text{ N/mm}^2$	$f_{yk} = 450 \text{ N/mm}^2$	$A_5 > 8\%$
<sup>1)</sup> Property class 70 for threaded rods up to M24 and Internal threaded anchor rods up to IG-M16, <sup>2)</sup> for IG-M20 only property class 50 <sup>3)</sup> Property class 80 only for stainless steel A4						
<b>EJOT Chemical Anchor MULTIFIX USF, MULTIFIX USF winter for concrete</b>					<b>Annex A 4</b>	
<b>Product description</b> Materials threaded rod and internal threaded rod						



Reinforcing bar  $\varnothing 8, \varnothing 10, \varnothing 12, \varnothing 14, \varnothing 16, \varnothing 20, \varnothing 25, \varnothing 28, \varnothing 32$

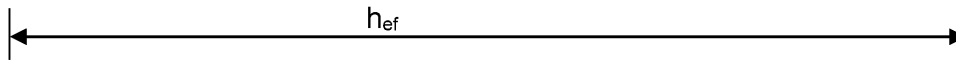
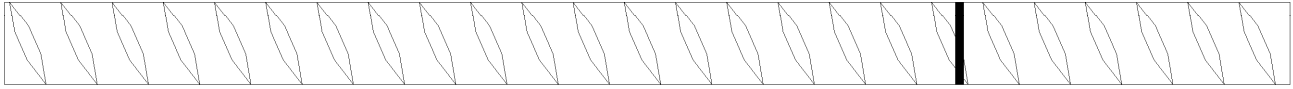

- Minimum value of related rip area  $f_{R,min}$  according to EN 1992-1-1:2004+AC:2010
- Rib height of the bar shall be in the range  $0,05d \leq h \leq 0,07d$   
(d: Nominal diameter of the bar; h: Rip height of the bar)

Table A2: Materials

Part	Designation	Material
<b>Reinforcing bars</b>		
1	Rebar EN 1992-1-1:2004+AC:2010, Annex C	Bars and de-coiled rods class B or C $f_{yk}$ and $k$ according to NDP or NCL of EN 1992-1-1/NA $f_{uk} = f_{tk} = k \cdot f_{yk}$

EJOT Chemical Anchor MULTIFIX USF, MULTIFIX USF winter for concrete

**Product description**  
Materials reinforcing bar

**Annex A 5**

### Specifications of intended use

#### Anchorage subject to:

- Static and quasi-static loads: M8 to M30, Rebar Ø8 to Ø32, IG-M6 to IG-M20.
- Seismic action for Performance Category C1: M8 to M30, Rebar Ø8 to Ø32.

#### Base materials:

- Compacted, reinforced or unreinforced normal weight concrete without fibres according to EN 206:2013 + A1:2016.
- Strength classes C20/25 to C50/60 according to EN 206:2013 + A1:2016.
- Non-cracked concrete: M8 to M30, Rebar Ø8 to Ø32, IG-M6 to IG-M20.
- Cracked concrete: M8 to M30, Rebar Ø8 to Ø32, IG-M6 to IG-M20.

#### Temperature Range:

- I: - 40 °C to +40 °C (max long term temperature +24 °C and max short term temperature +40 °C)
- II: - 40 °C to +80 °C (max long term temperature +50 °C and max short term temperature +80 °C)
- III: - 40 °C to +120 °C (max long term temperature +72 °C and max short term temperature +120 °C)

#### Use conditions (Environmental conditions):

- Structures subject to dry internal conditions (all materials).
- For all other conditions according to EN 1993-1-4:2006+A1:2015 corresponding to corrosion resistance class:
  - Stainless steel Stahl A2 according to Annex A 4, Table A1: CRC II
  - Stainless steel Stahl A4 according to Annex A 4, Table A1: CRC III
  - High corrosion resistance steel HCR according to Annex A 4, Table A1: CRC V

#### Design:

- Verifiable calculation notes and drawings are prepared taking account of the loads to be anchored. The position of the anchor is indicated on the design drawings (e. g. position of the anchor relative to reinforcement or to supports, etc.).
- Anchorages are designed under the responsibility of an engineer experienced in anchorages and concrete work.
- The anchorages are designed in accordance to EN 1992-4:2018 and Technical Report TR055, Edition February 2018

#### Installation:

- Dry or wet concrete: M8 to M30, Rebar Ø8 to Ø32, IG-M6 to IG-M20.
- Flooded holes (not sea water): M8 to M16, Rebar Ø8 to Ø16, IG-M6 to IG-M10.
- Hole drilling by hammer (HD), hollow (HDB) or compressed air drill mode (CD).
- Overhead installation allowed.
- Anchor installation carried out by appropriately qualified personnel and under the supervision of the person responsible for technical matters of the site.
- The injection mortar is assessed for installation at minimum concrete temperature of -10°C resp. -20°C, where subsequently the temperature in the concrete does not rise at a rapid rate, i.e. from the minimum installation temperature to 24°C within a 12-hour period.

EJOT Chemical Anchor MULTIFIX USF, MULTIFIX USF winter for concrete

Intended Use  
Specifications

Annex B 1

<b>Table B1: Installation parameters for threaded rod</b>										
Anchor size		M8	M10	M12	M16	M20	M24	M27	M30	
Outer diameter of anchor	$d_{nom}$ [mm] =	8	10	12	16	20	24	27	30	
Nominal drill hole diameter	$d_0$ [mm] =	10	12	14	18	24	28	32	35	
Effective embedment depth	$h_{ef,min}$ [mm] =	60	60	70	80	90	96	108	120	
	$h_{ef,max}$ [mm] =	160	200	240	320	400	480	540	600	
Diameter of clearance hole in the fixture	$d_f$ [mm] ≤	9	12	14	18	22	26	30	33	
Diameter of steel brush	$d_b$ [mm] ≥	12	14	16	20	26	30	34	37	
Maximum torque moment	$\max T_{inst}$ [Nm] ≤	10	20	40	80	120	160	180	200	
Minimum thickness of member	$h_{min}$ [mm]	$h_{ef} + 30 \text{ mm} \geq 100 \text{ mm}$			$h_{ef} + 2d_0$					
Minimum spacing	$s_{min}$ [mm]	40	50	60	80	100	120	135	150	
Minimum edge distance	$c_{min}$ [mm]	40	50	60	80	100	120	135	150	
<b>Table B2: Installation parameters for rebar</b>										
Rebar size		Ø 8	Ø 10	Ø 12	Ø 14	Ø 16	Ø 20	Ø 25	Ø 28	Ø 32
Outer diameter of anchor	$d_{nom}$ [mm] =	8	10	12	14	16	20	25	28	32
Nominal drill hole diameter	$d_0$ [mm] =	12	14	16	18	20	24	32	35	40
Effective embedment depth	$h_{ef,min}$ [mm] =	60	60	70	75	80	90	100	112	128
	$h_{ef,max}$ [mm] =	160	200	240	280	320	400	500	580	640
Diameter of steel brush	$d_b$ [mm] ≥	14	16	18	20	22	26	34	37	41,5
Minimum thickness of member	$h_{min}$ [mm]	$h_{ef} + 30 \text{ mm} \geq 100 \text{ mm}$			$h_{ef} + 2d_0$					
Minimum spacing	$s_{min}$ [mm]	40	50	60	70	80	100	125	140	160
Minimum edge distance	$c_{min}$ [mm]	40	50	60	70	80	100	125	140	160
<b>Table B3: Installation parameters for internal threaded anchor rod</b>										
Size internal threaded anchor rod		IG-M6	IG-M8	IG-M10	IG-M12	IG-M16	IG-M20			
Internal diameter of anchor	$d_2$ [mm] =	6	8	10	12	16	20			
Outer diameter of anchor <sup>1)</sup>	$d_{nom}$ [mm] =	10	12	16	20	24	30			
Nominal drill hole diameter	$d_0$ [mm] =	12	14	18	22	28	35			
Effective embedment depth	$h_{ef,min}$ [mm] =	60	70	80	90	96	120			
	$h_{ef,max}$ [mm] =	200	240	320	400	480	600			
Diameter of clearance hole in the fixture	$d_f$ [mm] =	7	9	12	14	18	22			
Maximum torque moment	$\max T_{inst}$ [Nm] ≤	10	10	20	40	60	100			
Thread engagement length min/max	$l_{IG}$ [mm] =	8/20	8/20	10/25	12/30	16/32	20/40			
Minimum thickness of member	$h_{min}$ [mm]	$h_{ef} + 30 \text{ mm} \geq 100 \text{ mm}$			$h_{ef} + 2d_0$					
Minimum spacing	$s_{min}$ [mm]	50	60	80	100	120	150			
Minimum edge distance	$c_{min}$ [mm]	50	60	80	100	120	150			
<sup>1)</sup> With metric threads according to EN 1993-1-8:2005+AC:2009										
<b>EJOT Chemical Anchor MULTIFIX USF, MULTIFIX USF winter for concrete</b>							<b>Annex B 2</b>			
<b>Intended Use</b> Installation parameters										

**Table B4: Parameter cleaning and setting tools**

Threaded Rod	Rebar	Internal threaded Anchor rod	$d_0$ Drill bit - $\emptyset$ HD, HDB, CA	Brush - $\emptyset$		Piston plug	Installation direction and use of piston plug			
				$d_b$	$d_{b,min}$ min.		$\downarrow$	$\rightarrow$	$\uparrow$	
[mm]	[mm]	[mm]	[mm]		[mm]	[mm]				
M8			10	RBT10	12	10,5	No piston plug required			
M10	8	IG-M6	12	RBT12	14	12,5				
M12	10	IG-M8	14	RBT14	16	14,5				
	12		16	RBT16	18	16,5				
M16	14	IG-M10	18	RBT18	20	18,5	VS18	$h_{ef} > 250$ mm	$h_{ef} > 250$ mm	all
	16		20	RBT20	22	20,5	VS20			
M20	20	IG-M12	24	RBT24	26	24,5	VS24			
M24		IG-M16	28	RBT28	30	28,5	VS28			
M27	25		32	RBT32	34	32,5	VS32			
M30	28	IG-M20	35	RBT35	37	35,5	VS35			
	32		40	RBT40	41,5	40,5	VS40			



**MAC - Hand pump (volume 750 ml)**  
Drill bit diameter ( $d_0$ ): 10 mm to 20 mm  
Drill hole depth ( $h_0$ ):  $< 10 d_{nom}$   
Only in non-cracked concrete



**CAC - Rec. compressed air tool (min 6 bar)**  
Drill bit diameter ( $d_0$ ): all diameters



**Piston plug for overhead or horizontal installation VS**  
Drill bit diameter ( $d_0$ ): 18 mm to 40 mm







**Steel brush RBT**  
Drill bit diameter ( $d_0$ ): all diameters

EJOT Chemical Anchor MULTIFIX USF, MULTIFIX USF winter for concrete

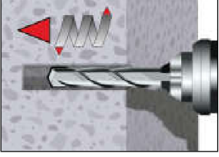
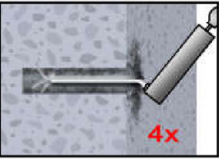
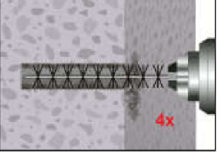
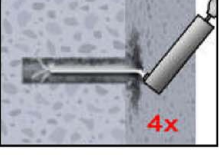
**Intended Use**  
Cleaning and setting tools

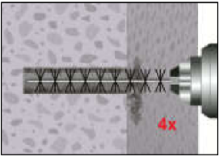
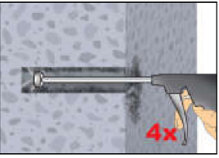
**Annex B 3**

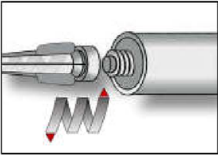
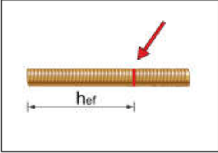
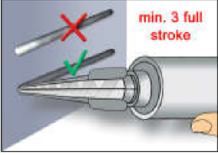
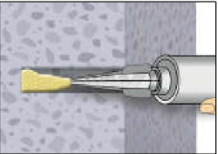
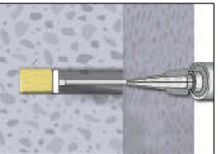
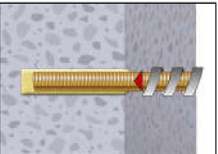
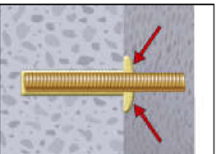
Installation instructions	
Drilling of the bore hole	
	<p>1. Drill with hammer drill a hole into the base material to the size and embedment depth required by the selected anchor (Table B1, B2, or B3), with hammer (HD), hollow (HDB) or compressed air (CD) drilling. The use of a hollow drill bit is only in combination with a sufficient vacuum permitted. In case of aborted drill hole: The drill hole shall be filled with mortar</p>
<b>Attention! Standing water in the bore hole must be removed before cleaning.</b>	
MAC: Cleaning for bore hole diameter $d_0 \leq 20\text{mm}$ and bore hole depth $h_0 \leq 10d_{\text{nom}}$ (uncracked concrete only!)	
	<p>2a. Starting from the bottom or back of the bore hole, blow the hole clean by a hand pump <sup>1)</sup> (Annex B 3) a minimum of four times.</p>
	<p>2b. Check brush diameter (Table B4). Brush the hole with an appropriate sized wire brush <math>&gt; d_{b,\text{min}}</math> (Table B4) a minimum of four times in a twisting motion. If the bore hole ground is not reached with the brush, a brush extension must be used.</p>
	<p>2c. Finally blow the hole clean again with a hand pump (Annex B 3) a minimum of four times.</p> <p><sup>1)</sup> It is permitted to blow bore holes with diameter between 14 mm and 20 mm and an embedment depth up to <math>10d_{\text{nom}}</math> also in cracked concrete with hand-pump.</p>
CAC: Cleaning for all bore hole diameter in uncracked and cracked concrete	
	<p>2a. Starting from the bottom or back of the bore hole, blow the hole clean with compressed air (min. 6 bar) (Annex B 3) a minimum of four times until return air stream is free of noticeable dust. If the bore hole ground is not reached an extension must be used.</p>
	<p>2b. Check brush diameter (Table B4). Brush the hole with an appropriate sized wire brush <math>&gt; d_{b,\text{min}}</math> (Table B4) a minimum of four times in a twisting motion. If the bore hole ground is not reached with the brush, a brush extension must be used.</p>
	<p>2c. Finally blow the hole clean again with compressed air (min. 6 bar) (Annex B 3) a minimum of four times until return air stream is free of noticeable dust. If the bore hole ground is not reached an extension must be used.</p>
<p><b>After cleaning, the bore hole has to be protected against re-contamination in an appropriate way, until dispensing the mortar in the bore hole. If necessary, the cleaning has to be repeated directly before dispensing the mortar. In-flowing water must not contaminate the bore hole again.</b></p>	
EJOT Chemical Anchor MULTIFIX USF, MULTIFIX USF winter for concrete	
Intended Use Installation instructions	<b>Annex B 4</b>

<b>Installation instructions (continuation)</b>	
  	<p>3. Attach the supplied static-mixing nozzle to the cartridge and load the cartridge into the correct dispensing tool. Cut off the foil tube clip before use. For every working interruption longer than the recommended working time (Annex B 6) as well as for new cartridges, a new static-mixer shall be used.</p> <p>4. Prior to inserting the anchor rod into the filled bore hole, the position of the embedment depth shall be marked on the anchor rods.</p> <p>5. Prior to dispensing into the anchor hole, squeeze out separately a minimum of three full strokes and discard non-uniformly mixed adhesive components until the mortar shows a consistent grey colour. For foil tube cartridges it must be discarded a minimum of six full strokes.</p>
     	<p>6. Starting from the bottom or back of the cleaned anchor hole, fill the hole up to approximately two-thirds with adhesive. Slowly withdraw the static mixing nozzle as the hole fills to avoid creating air pockets. If the bottom or back of the anchor hole is not reached, an appropriate extension nozzle must be used. Observe the gel-/ working times given in Annex B 6.</p> <p>7. Piston plugs and mixer nozzle extensions shall be used according to Table B4 for the following applications:</p> <ul style="list-style-type: none"> <li>• Horizontal assembly (horizontal direction) and ground erection (vertical downwards direction): Drill bit-<math>\varnothing</math> <math>d_0 \geq 18</math> mm and embedment depth <math>h_{ef} &gt; 250</math>mm</li> <li>• Overhead assembly (vertical upwards direction): Drill bit-<math>\varnothing</math> <math>d_0 \geq 18</math> mm</li> </ul> <p>8. Push the threaded rod or reinforcing bar into the anchor hole while turning slightly to ensure positive distribution of the adhesive until the embedment depth is reached.</p> <p>The anchor shall be free of dirt, grease, oil or other foreign material.</p> <p>9. Be sure that the anchor is fully seated at the bottom of the hole and that excess mortar is visible at the top of the hole. If these requirements are not maintained, the application has to be renewed. For overhead application the anchor rod shall be fixed (e.g. wedges).</p> <p>10. Allow the adhesive to cure to the specified time prior to applying any load or torque. Do not move or load the anchor until it is fully cured (attend Annex B 6).</p> <p>11. After full curing, the add-on part can be installed with up to the max. torque (Table B1 or B3) by using a calibrated torque wrench. It can be optional filled the annular gap between anchor and fixture with mortar. Therefor substitute the washer by the filling washer and connect the mixer reduction nozzle to the tip of the mixer. The annular gap is filled with mortar, when mortar oozes out of the washer.</p>
<p><b>EJOT Chemical Anchor MULTIFIX USF, MULTIFIX USF winter for concrete</b></p>	
<p><b>Intended Use</b> Installation instructions (continuation)</p>	
<p><b>Annex B 5</b></p>	

<b>Table B5: Maximum working time and minimum curing time Multifix USF</b>		
<b>Concrete temperature</b>	<b>Gelling- / working time</b>	<b>Minimum curing time in dry concrete <sup>1)</sup></b>
-10 °C to -6°C	90 min <sup>2)</sup>	24 h <sup>2)</sup>
-5 °C to -1°C	90 min	14 h
0 °C to +4°C	45 min	7 h
+5 °C to +9°C	25 min	2 h
+ 10 °C to +19°C	15 min	80 min
+ 20 °C to +29°C	6 min	45 min
+ 30 °C to +34°C	4 min	25 min
+ 35 °C to +39°C	2 min	20 min
+ 40 °C	1,5 min	15 min
Cartridge temperature	+5°C to +40°C	
<sup>1)</sup> In wet concrete the curing time must be doubled. <sup>2)</sup> Cartridge temperature must be at min. +15°C.		
<b>Table B6: Maximum working time and minimum curing time Multifix USF Winter</b>		
<b>Concrete temperature</b>	<b>Gelling- / working time</b>	<b>Minimum curing time in dry concrete <sup>1)</sup></b>
-20 °C to -16°C	75 min	24 h
-15 °C to -11°C	55 min	16 h
-10 °C to -6°C	35 min	10 h
-5 °C to -1°C	20 min	5 h
0 °C to +4°C	10 min	2,5 h
+5 °C to +9°C	6 min	80 Min
+ 10 °C	6 min	60 Min
Cartridge temperature	-20°C to +10°C	
<sup>1)</sup> In wet concrete the curing time must be doubled.		
<b>EJOT Chemical Anchor MULTIFIX USF, MULTIFIX USF winter for concrete</b>		<b>Annex B 6</b>
<b>Intended Use</b> Curing time		

<b>Table C1: Characteristic values for steel tension resistance and steel shear resistance of threaded rods</b>											
<b>Size</b>			<b>M8</b>	<b>M10</b>	<b>M12</b>	<b>M16</b>	<b>M20</b>	<b>M24</b>	<b>M27</b>	<b>M30</b>	
Cross section area	$A_s$	[mm <sup>2</sup> ]	36,6	58	84,3	157	245	353	459	561	
Characteristic tension resistance, Steel failure <sup>1)</sup>											
Steel, Property class 4.6 and 4.8	$N_{Rk,s}$	[kN]	15 (13)	23 (21)	34	63	98	141	184	224	
Steel, Property class 5.6 and 5.8	$N_{Rk,s}$	[kN]	18 (17)	29 (27)	42	78	122	176	230	280	
Steel, Property class 8.8	$N_{Rk,s}$	[kN]	29 (27)	46 (43)	67	125	196	282	368	449	
Stainless steel A2, A4 and HCR, class 50	$N_{Rk,s}$	[kN]	18	29	42	79	123	177	230	281	
Stainless steel A2, A4 and HCR, class 70	$N_{Rk,s}$	[kN]	26	41	59	110	171	247	- <sup>3)</sup>	- <sup>3)</sup>	
Stainless steel A4 and HCR, class 80	$N_{Rk,s}$	[kN]	29	46	67	126	196	282	- <sup>3)</sup>	- <sup>3)</sup>	
Characteristic tension resistance, Partial factor <sup>2)</sup>											
Steel, Property class 4.6 and 5.6	$\gamma_{Ms,N}$	[-]	2,0								
Steel, Property class 4.8, 5.8 and 8.8	$\gamma_{Ms,N}$	[-]	1,5								
Stainless steel A2, A4 and HCR, class 50	$\gamma_{Ms,N}$	[-]	2,86								
Stainless steel A2, A4 and HCR, class 70	$\gamma_{Ms,N}$	[-]	1,87								
Stainless steel A4 and HCR, class 80	$\gamma_{Ms,N}$	[-]	1,6								
Characteristic shear resistance, Steel failure <sup>1)</sup>											
Without lever arm	Steel, Property class 4.6 and 4.8	$V^0_{Rk,s}$	[kN]	9 (8)	14 (13)	20	38	59	85	110	135
	Steel, Property class 5.6 and 5.8	$V^0_{Rk,s}$	[kN]	11 (10)	17 (16)	25	47	74	106	138	168
	Steel, Property class 8.8	$V^0_{Rk,s}$	[kN]	15 (13)	23 (21)	34	63	98	141	184	224
	Stainless steel A2, A4 and HCR, class 50	$V^0_{Rk,s}$	[kN]	9	15	21	39	61	88	115	140
	Stainless steel A2, A4 and HCR, class 70	$V^0_{Rk,s}$	[kN]	13	20	30	55	86	124	- <sup>3)</sup>	- <sup>3)</sup>
	Stainless steel A4 and HCR, class 80	$V^0_{Rk,s}$	[kN]	15	23	34	63	98	141	- <sup>3)</sup>	- <sup>3)</sup>
With lever arm	Steel, Property class 4.6 and 4.8	$M^0_{Rk,s}$	[Nm]	15 (13)	30 (27)	52	133	260	449	666	900
	Steel, Property class 5.6 and 5.8	$M^0_{Rk,s}$	[Nm]	19 (16)	37 (33)	65	166	324	560	833	1123
	Steel, Property class 8.8	$M^0_{Rk,s}$	[Nm]	30 (26)	60 (53)	105	266	519	896	1333	1797
	Stainless steel A2, A4 and HCR, class 50	$M^0_{Rk,s}$	[Nm]	19	37	66	167	325	561	832	1125
	Stainless steel A2, A4 and HCR, class 70	$M^0_{Rk,s}$	[Nm]	26	52	92	232	454	784	- <sup>3)</sup>	- <sup>3)</sup>
	Stainless steel A4 and HCR, class 80	$M^0_{Rk,s}$	[Nm]	30	59	105	266	519	896	- <sup>3)</sup>	- <sup>3)</sup>
Characteristic shear resistance, Partial factor <sup>2)</sup>											
Steel, Property class 4.6 and 5.6	$\gamma_{Ms,V}$	[-]	1,67								
Steel, Property class 4.8, 5.8 and 8.8	$\gamma_{Ms,V}$	[-]	1,25								
Stainless steel A2, A4 and HCR, class 50	$\gamma_{Ms,V}$	[-]	2,38								
Stainless steel A2, A4 and HCR, class 70	$\gamma_{Ms,V}$	[-]	1,56								
Stainless steel A4 and HCR, class 80	$\gamma_{Ms,V}$	[-]	1,33								
<sup>1)</sup> Values are only valid for the given stress area $A_s$ . Values in brackets are valid for undersized threaded rods with smaller stress area $A_s$ for hot-dip galvanised threaded rods according to EN ISO 10684:2004+AC:2009. <sup>2)</sup> in absence of national regulation <sup>3)</sup> Anchor type not part of the ETA											
<b>EJOT Chemical Anchor MULTIFIX USF, MULTIFIX USF winter for concrete</b>									<b>Annex C 1</b>		
<b>Performances</b> Characteristic values for steel tension resistance and steel shear resistance of threaded rods											



<b>Table C2: Characteristic values for Concrete cone failure and Splitting with all kind of action</b>				
<b>Anchor size</b>			<b>All Anchor types and sizes</b>	
<b>Concrete cone failure</b>				
Non-cracked concrete		$k_{ucr,N}$	[-]	11,0
Cracked concrete		$k_{cr,N}$	[-]	7,7
Edge distance		$c_{cr,N}$	[mm]	1,5 $h_{ef}$
Axial distance		$s_{cr,N}$	[mm]	2 $c_{cr,N}$
<b>Splitting</b>				
Edge distance	$h/h_{ef} \geq 2,0$	$c_{cr,sp}$	[mm]	1,0 $h_{ef}$
	$2,0 > h/h_{ef} > 1,3$			$2 \cdot h_{ef} \left( 2,5 - \frac{h}{h_{ef}} \right)$
	$h/h_{ef} \leq 1,3$			2,4 $h_{ef}$
Axial distance		$s_{cr,sp}$	[mm]	2 $c_{cr,sp}$
<b>EJOT Chemical Anchor MULTIFIX USF, MULTIFIX USF winter for concrete</b>				<b>Annex C 2</b>
<b>Performances</b> Characteristic values for Concrete cone failure and Splitting with all kind of action				

<b>Table C3: Characteristic values of tension loads under static and quasi-static action</b>													
<b>Anchor size threaded rod</b>				<b>M8</b>	<b>M10</b>	<b>M12</b>	<b>M16</b>	<b>M20</b>	<b>M24</b>	<b>M27</b>	<b>M30</b>		
<b>Steel failure</b>													
Characteristic tension resistance		$N_{Rk,s}$	[kN]	$A_s \cdot f_{uk}$ (or see Table C1)									
Partial factor		$\gamma_{Ms,N}$	[-]	see Table C1									
<b>Combined pull-out and concrete failure</b>													
Characteristic bond resistance in non-cracked concrete C20/25													
Temperature range	I: 40°C/24°C	Dry, wet concrete	$\tau_{Rk,ucr}$	[N/mm <sup>2</sup> ]	10	12	12	12	12	11	10	9	
	II: 80°C/50°C				7,5	9	9	9	9	8,5	7,5	6,5	
	III: 120°C/72°C				5,5	6,5	6,5	6,5	6,5	6,5	5,5	5,0	
	I: 40°C/24°C	flooded bore hole			7,5	8,5	8,5	8,5	No Performance Assessed				
	II: 80°C/50°C				5,5	6,5	6,5	6,5					
	III: 120°C/72°C				4,0	5,0	5,0	5,0					
Characteristic bond resistance in cracked concrete C20/25													
Temperature range	I: 40°C/24°C	Dry, wet concrete	$\tau_{Rk,cr}$	[N/mm <sup>2</sup> ]	4,0	5,0	5,5	5,5	5,5	5,5	6,5	6,5	
	II: 80°C/50°C				2,5	3,5	4,0	4,0	4,0	4,0	4,5	4,5	
	III: 120°C/72°C				2,0	2,5	3,0	3,0	3,0	3,0	3,5	3,5	
	I: 40°C/24°C	flooded bore hole			4,0	4,0	5,5	5,5	No Performance Assessed				
	II: 80°C/50°C				2,5	3,0	4,0	4,0					
	III: 120°C/72°C				2,0	2,5	3,0	3,0					
Reduktion factor $\psi_{sus}^0$ in cracked and non-cracked concrete C20/25													
Temperature range	I: 40°C/24°C	Dry, wet concrete and flooded bore hole	$\psi_{sus}^0$	[-]	0,73								
	II: 80°C/50°C				0,65								
	III: 120°C/72°C				0,57								
Increasing factors for concrete $\psi_c$			C25/30		1,02								
			C30/37		1,04								
			C35/45		1,07								
			C40/50		1,08								
			C45/55		1,09								
			C50/60		1,10								
<b>Concrete cone failure</b>													
Relevant parameter				see Table C2									
<b>Splitting</b>													
Relevant parameter				see Table C2									
<b>Installation factor</b>													
for dry and wet concrete		$\gamma_{inst}$	[-]	1,0	1,2								
for flooded bore hole				1,4	No Performance Assessed								
<b>EJOT Chemical Anchor MULTIFIX USF, MULTIFIX USF winter for concrete</b>										<b>Annex C 3</b>			
<b>Performances</b> Characteristic values of tension loads under static and quasi-static action													

Table C4: Characteristic values of shear loads under static and quasi-static action											
Anchor size threaded rod			M8	M10	M12	M16	M20	M24	M27	M30	
<b>Steel failure without lever arm</b>											
Characteristic shear resistance Steel, strength class 4.6, 4.8, 5.6 and 5.8	$V_{Rk,s}^0$	[kN]	$0,6 \cdot A_s \cdot f_{uk}$ (or see Table C1)								
Characteristic shear resistance Steel, strength class 8.8 Stainless Steel A2, A4 and HCR, all classes	$V_{Rk,s}^0$	[kN]	$0,5 \cdot A_s \cdot f_{uk}$ (or see Table C1)								
Partial factor	$\gamma_{Ms,V}$	[-]	see Table C1								
Ductility factor	$k_7$	[-]	1,0								
<b>Steel failure with lever arm</b>											
Characteristic bending moment	$M_{Rk,s}^0$	[Nm]	$1,2 \cdot W_{el} \cdot f_{uk}$ (or see Table C1)								
Elastic section modulus	$W_{el}$	[mm <sup>3</sup> ]	31	62	109	277	541	935	1387	1874	
Partial factor	$\gamma_{Ms,V}$	[-]	see Table C1								
<b>Concrete pry-out failure</b>											
Factor	$k_8$	[-]	2,0								
Installation factor	$\gamma_{inst}$	[-]	1,0								
<b>Concrete edge failure</b>											
Effective length of fastener	$l_f$	[mm]	$\min(h_{ef}; 12 \cdot d_{nom})$						$\min(h_{ef}; 300\text{mm})$		
Outside diameter of fastener	$d_{nom}$	[mm]	8	10	12	16	20	24	27	30	
Installation factor	$\gamma_{inst}$	[-]	1,0								
<b>EJOT Chemical Anchor MULTIFIX USF, MULTIFIX USF winter for concrete</b>									<b>Annex C 4</b>		
<b>Performances</b> Characteristic values of shear loads under static and quasi-static action											

Table C5: Characteristic values of tension loads under static and quasi-static action											
Anchor size internal threaded anchor rods				IG-M6	IG-M8	IG-M10	IG-M12	IG-M16	IG-M20		
<b>Steel failure<sup>1)</sup></b>											
Characteristic tension resistance,	5.8	$N_{Rk,s}$	[kN]	10	17	29	42	76	123		
Steel, strength class	8.8	$N_{Rk,s}$	[kN]	16	27	46	67	121	196		
Partial factor, strength class 5.8 and 8.8		$\gamma_{Ms,N}$	[-]	1,5							
Characteristic tension resistance, Stainless Steel A4 and HCR, Strength class 70 <sup>2)</sup>		$N_{Rk,s}$	[kN]	14	26	41	59	110	124		
Partial factor		$\gamma_{Ms,N}$	[-]	1,87					2,86		
<b>Combined pull-out and concrete cone failure</b>											
Characteristic bond resistance in non-cracked concrete C20/25											
Temperature range	I: 40°C/24°C	Dry, wet concrete	$\tau_{Rk,ucr}$	[N/mm <sup>2</sup> ]	12	12	12	12	11	9	
	II: 80°C/50°C				9	9	9	9	8,5	6,5	
	III: 120°C/72°C				6,5	6,5	6,5	6,5	6,5	5,0	
	I: 40°C/24°C	flooded bore hole			8,5	8,5	8,5	No Performance Assessed			
	II: 80°C/50°C				6,5	6,5	6,5				
	III: 120°C/72°C				5,0	5,0	5,0				
Characteristic bond resistance in cracked concrete C20/25											
Temperature range	I: 40°C/24°C	Dry, wet concrete	$\tau_{Rk,cr}$	[N/mm <sup>2</sup> ]	5,0	5,5	5,5	5,5	5,5	6,5	
	II: 80°C/50°C				3,5	4,0	4,0	4,0	4,0	4,5	
	III: 120°C/72°C				2,5	3,0	3,0	3,0	3,0	3,5	
	I: 40°C/24°C	flooded bore hole			4,0	5,5	5,5	No Performance Assessed			
	II: 80°C/50°C				3,0	4,0	4,0				
	III: 120°C/72°C				2,5	3,0	3,0				
Reduktion factor $\psi_{sus}^0$ in cracked and non-cracked concrete C20/25											
Temperature range	I: 40°C/24°C	Dry, wet concrete and flooded bore hole	$\psi_{sus}^0$	[-]	0,73						
	II: 80°C/50°C				0,65						
	III: 120°C/72°C				0,57						
Increasing factors for concrete $\psi_c$			C25/30		1,02						
			C30/37		1,04						
			C35/45		1,07						
			C40/50		1,08						
			C45/55		1,09						
			C50/60		1,10						
<b>Concrete cone failure</b>											
Relevant parameter				see Table C2							
<b>Splitting failure</b>											
Relevant parameter				see Table C2							
<b>Installation factor</b>											
for dry and wet concrete				$\gamma_{inst}$	[-]	1,2					
for flooded bore hole						1,4	No Performance Assessed				
<sup>1)</sup> Fastenings (incl. nut and washer) must comply with the appropriate material and property class of the internal threaded rod. The characteristic tension resistance for steel failure is valid for the internal threaded rod and the fastening element. <sup>2)</sup> For IG-M20 strength class 50 is valid											
<b>EJOT Chemical Anchor MULTIFIX USF, MULTIFIX USF winter for concrete</b>								<b>Annex C 5</b>			
<b>Performances</b> Characteristic values of tension loads under static and quasi-static action											

Table C6: Characteristic values of shear loads under static and quasi-static action									
Anchor size for internal threaded anchor rods				IG-M6	IG-M8	IG-M10	IG-M12	IG-M16	IG-M20
<b>Steel failure without lever arm<sup>1)</sup></b>									
Characteristic shear resistance, Steel, strength class	5.8	$V_{Rk,s}^0$	[kN]	5	9	15	21	38	61
	8.8	$V_{Rk,s}^0$	[kN]	8	14	23	34	60	98
Partial factor, strength class 5.8 and 8.8	$\gamma_{Ms,V}$	[-]	1,25						
Characteristic shear resistance, Stainless Steel A4 and HCR, Strength class 70 <sup>2)</sup>		$V_{Rk,s}^0$	[kN]	7	13	20	30	55	40
	Partial factor	$\gamma_{Ms,V}$	[-]	1,56					2,38
Ductility factor	$k_7$	[-]	1,0						
<b>Steel failure with lever arm<sup>1)</sup></b>									
Characteristic bending moment, Steel, strength class	5.8	$M_{Rk,s}^0$	[Nm]	8	19	37	66	167	325
	8.8	$M_{Rk,s}^0$	[Nm]	12	30	60	105	267	519
Partial factor, strength class 5.8 and 8.8	$\gamma_{Ms,V}$	[-]	1,25						
Characteristic bending moment, Stainless Steel A4 and HCR, Strength class 70 <sup>2)</sup>		$M_{Rk,s}^0$	[Nm]	11	26	52	92	233	456
	Partial factor	$\gamma_{Ms,V}$	[-]	1,56					2,38
<b>Concrete pry-out failure</b>									
Factor	$k_8$	[-]	2,0						
Installation factor	$\gamma_{inst}$	[-]	1,0						
<b>Concrete edge failure</b>									
Effective length of fastener	$l_f$	[mm]	$\min(h_{ef}; 12 \cdot d_{nom})$						$\min(h_{ef}; 300\text{mm})$
Outside diameter of fastener	$d_{nom}$	[mm]	10	12	16	20	24	30	
Installation factor	$\gamma_{inst}$	[-]	1,0						
<sup>1)</sup> Fastenings (incl. nut and washer) must comply with the appropriate material and property class of the internal threaded rod. The characteristic tension resistance for steel failure is valid for the internal threaded rod and the fastening element. <sup>2)</sup> For IG-M20 strength class 50 is valid									
<b>EJOT Chemical Anchor MULTIFIX USF, MULTIFIX USF winter for concrete</b>								<b>Annex C 6</b>	
<b>Performances</b> Characteristic values of shear loads under static and quasi-static action									

<b>Table C7: Characteristic values of tension loads under static and quasi-static action</b>														
<b>Anchor size reinforcing bar</b>			Ø 8	Ø 10	Ø 12	Ø 14	Ø 16	Ø 20	Ø 25	Ø 28	Ø 32			
<b>Steel failure</b>														
Characteristic tension resistance	$N_{Rk,s}$	[kN]	$A_s \cdot f_{uk}^{1)}$											
Cross section area	$A_s$	[mm <sup>2</sup> ]	50	79	113	154	201	314	491	616	804			
Partial factor	$\gamma_{Ms,N}$	[-]	1,4 <sup>2)</sup>											
<b>Combined pull-out and concrete failure</b>														
Characteristic bond resistance in non-cracked concrete C20/25														
Temperature range	I: 40°C/24°C	Dry, wet concrete	$\tau_{Rk,ucr}$	[N/mm <sup>2</sup> ]	10	12	12	12	12	12	11	10	8,5	
	II: 80°C/50°C				7,5	9	9	9	9	9	8,0	7,0	6,0	
	III: 120°C/72°C				5,5	6,5	6,5	6,5	6,5	6,5	6,0	5,0	4,5	
	I: 40°C/24°C	flooded bore hole			7,5	8,5	8,5	8,5	8,5	No Performance Assessed				
	II: 80°C/50°C				5,5	6,5	6,5	6,5	6,5					
	III: 120°C/72°C				4,0	5,0	5,0	5,0	5,0					
Characteristic bond resistance in cracked concrete C20/25														
Temperature range	I: 40°C/24°C	Dry, wet concrete	$\tau_{Rk,cr}$	[N/mm <sup>2</sup> ]	4,0	5,0	5,5	5,5	5,5	5,5	5,5	6,5	6,5	
	II: 80°C/50°C				2,5	3,5	4,0	4,0	4,0	4,0	4,0	4,5	4,5	
	III: 120°C/72°C				2,0	2,5	3,0	3,0	3,0	3,0	3,0	3,5	3,5	
	I: 40°C/24°C	flooded bore hole			4,0	4,0	5,5	5,5	5,5	No Performance Assessed				
	II: 80°C/50°C				2,5	3,0	4,0	4,0	4,0					
	III: 120°C/72°C				2,0	2,5	3,0	3,0	3,0					
Reduktion factor $\psi_{sus}^0$ in cracked and non-cracked concrete C20/25														
Temperature range	I: 40°C/24°C	Dry, wet concrete and flooded bore hole	$\psi_{sus}^0$	[-]	0,73									
	II: 80°C/50°C				0,65									
	III: 120°C/72°C				0,57									
Increasing factors for concrete $\psi_c$	C25/30			1,02										
	C30/37			1,04										
	C35/45			1,07										
	C40/50			1,08										
	C45/55			1,09										
C50/60			1,10											
<b>Concrete cone failure</b>														
Relevant parameter			see Table C2											
<b>Splitting</b>														
Relevant parameter			see Table C2											
<b>Installation factor</b>														
for dry and wet concrete			$\gamma_{inst}$	[-]	1,2	1,2								
for flooded bore hole					1,4							No Performance Assessed		
<sup>1)</sup> $f_{uk}$ shall be taken from the specifications of reinforcing bars <sup>2)</sup> in absence of national regulation														
<b>EJOT Chemical Anchor MULTIFIX USF, MULTIFIX USF winter for concrete</b>										<b>Annex C 7</b>				
<b>Performances</b> Characteristic values of tension loads under static and quasi-static action														

<b>Table C8: Characteristic values of shear loads under static and quasi-static action</b>											
<b>Anchor size reinforcing bar</b>		Ø 8	Ø 10	Ø 12	Ø 14	Ø 16	Ø 20	Ø 25	Ø 28	Ø 32	
<b>Steel failure without lever arm</b>											
Characteristic shear resistance	$V_{Rk,s}^0$	[kN]	$0,50 \cdot A_s \cdot f_{uk}^{1)}$								
Cross section area	$A_s$	[mm <sup>2</sup> ]	50	79	113	154	201	314	491	616	804
Partial factor	$\gamma_{Ms,V}$	[-]	1,5 <sup>2)</sup>								
Ductility factor	$k_7$	[-]	1,0								
<b>Steel failure with lever arm</b>											
Characteristic bending moment	$M_{Rk,s}^0$	[Nm]	$1,2 \cdot W_{el} \cdot f_{uk}^{1)}$								
Elastic section modulus	$W_{el}$	[mm <sup>3</sup> ]	50	98	170	269	402	785	1534	2155	3217
Partial factor	$\gamma_{Ms,V}$	[-]	1,5 <sup>2)</sup>								
<b>Concrete pry-out failure</b>											
Factor	$k_8$	[-]	2,0								
Installation factor	$\gamma_{inst}$	[-]	1,0								
<b>Concrete edge failure</b>											
Effective length of fastener	$l_f$	[mm]	$\min(h_{ef}; 12 \cdot d_{nom})$						$\min(h_{ef}; 300\text{mm})$		
Outside diameter of fastener	$d_{nom}$	[mm]	8	10	12	14	16	20	25	28	32
Installation factor	$\gamma_{inst}$	[-]	1,0								
<sup>1)</sup> $f_{uk}$ shall be taken from the specifications of reinforcing bars <sup>2)</sup> in absence of national regulation											
<b>EJOT Chemical Anchor MULTIFIX USF, MULTIFIX USF winter for concrete</b>									<b>Annex C 8</b>		
<b>Performances</b> Characteristic values of shear loads under static and quasi-static action											

<b>Table C9: Displacements under tension load<sup>1)</sup> (threaded rod)</b>										
<b>Anchor size threaded rod</b>			<b>M8</b>	<b>M10</b>	<b>M12</b>	<b>M16</b>	<b>M20</b>	<b>M24</b>	<b>M27</b>	<b>M30</b>
<b>Non-cracked concrete C20/25 under static and quasi-static action</b>										
Temperature range I: 40°C/24°C	$\delta_{N0}$ -factor	[mm/(N/mm <sup>2</sup> )]	0,021	0,023	0,026	0,031	0,036	0,041	0,045	0,049
	$\delta_{N\infty}$ -factor	[mm/(N/mm <sup>2</sup> )]	0,030	0,033	0,037	0,045	0,052	0,060	0,065	0,071
Temperature range II: 80°C/50°C	$\delta_{N0}$ -factor	[mm/(N/mm <sup>2</sup> )]	0,050	0,056	0,063	0,075	0,088	0,100	0,110	0,119
	$\delta_{N\infty}$ -factor	[mm/(N/mm <sup>2</sup> )]	0,072	0,081	0,090	0,108	0,127	0,145	0,159	0,172
Temperature range III: 120°C/72°C	$\delta_{N0}$ -factor	[mm/(N/mm <sup>2</sup> )]	0,050	0,056	0,063	0,075	0,088	0,100	0,110	0,119
	$\delta_{N\infty}$ -factor	[mm/(N/mm <sup>2</sup> )]	0,072	0,081	0,090	0,108	0,127	0,145	0,159	0,172
<b>Cracked concrete C20/25 under static and quasi-static action</b>										
Temperature range I: 40°C/24°C	$\delta_{N0}$ -factor	[mm/(N/mm <sup>2</sup> )]	0,090				0,070			
	$\delta_{N\infty}$ -factor	[mm/(N/mm <sup>2</sup> )]	0,105				0,105			
Temperature range II: 80°C/50°C	$\delta_{N0}$ -factor	[mm/(N/mm <sup>2</sup> )]	0,219				0,170			
	$\delta_{N\infty}$ -factor	[mm/(N/mm <sup>2</sup> )]	0,255				0,245			
Temperature range III: 120°C/72°C	$\delta_{N0}$ -factor	[mm/(N/mm <sup>2</sup> )]	0,219				0,170			
	$\delta_{N\infty}$ -factor	[mm/(N/mm <sup>2</sup> )]	0,255				0,245			
<sup>1)</sup> Calculation of the displacement $\delta_{N0} = \delta_{N0}\text{-factor} \cdot \tau$ ; $\tau$ : action bond stress for tension $\delta_{N\infty} = \delta_{N\infty}\text{-factor} \cdot \tau$ ;										
<b>Table C10: Displacements under shear load<sup>1)</sup> (threaded rod)</b>										
<b>Anchor size threaded rod</b>			<b>M8</b>	<b>M10</b>	<b>M12</b>	<b>M16</b>	<b>M20</b>	<b>M24</b>	<b>M27</b>	<b>M30</b>
<b>Non-cracked concrete C20/25 under static and quasi-static action</b>										
All temperature ranges	$\delta_{V0}$ -factor	[mm/kN]	0,06	0,06	0,05	0,04	0,04	0,03	0,03	0,03
	$\delta_{V\infty}$ -factor	[mm/kN]	0,09	0,08	0,08	0,06	0,06	0,05	0,05	0,05
<b>Cracked concrete C20/25 under static and quasi-static action</b>										
All temperature ranges	$\delta_{V0}$ -factor	[mm/kN]	0,12	0,12	0,11	0,10	0,09	0,08	0,08	0,07
	$\delta_{V\infty}$ -factor	[mm/kN]	0,18	0,18	0,17	0,15	0,14	0,13	0,12	0,10
<sup>1)</sup> Calculation of the displacement $\delta_{V0} = \delta_{V0}\text{-factor} \cdot V$ ; $V$ : action shear load $\delta_{V\infty} = \delta_{V\infty}\text{-factor} \cdot V$ ;										
<b>EJOT Chemical Anchor MULTIFIX USF, MULTIFIX USF winter for concrete</b>								<b>Annex C 9</b>		
<b>Performances</b> Displacements (threaded rods)										



<b>Table C11: Displacements under tension load<sup>1)</sup> (Internal threaded anchor rod)</b>								
<b>Anchor size Internal threaded anchor rod</b>			<b>IG-M6</b>	<b>IG-M8</b>	<b>IG-M10</b>	<b>IG-M12</b>	<b>IG-M16</b>	<b>IG-M20</b>
<b>Non-cracked concrete C20/25 under static and quasi-static action</b>								
Temperature range I: 40°C/24°C	$\delta_{N0}$ -factor	[mm/(N/mm <sup>2</sup> )]	0,023	0,026	0,031	0,036	0,041	0,049
	$\delta_{N\infty}$ -factor	[mm/(N/mm <sup>2</sup> )]	0,033	0,037	0,045	0,052	0,060	0,071
Temperature range II: 80°C/50°C	$\delta_{N0}$ -factor	[mm/(N/mm <sup>2</sup> )]	0,056	0,063	0,075	0,088	0,100	0,119
	$\delta_{N\infty}$ -factor	[mm/(N/mm <sup>2</sup> )]	0,081	0,090	0,108	0,127	0,145	0,172
Temperature range III: 120°C/72°C	$\delta_{N0}$ -factor	[mm/(N/mm <sup>2</sup> )]	0,056	0,063	0,075	0,088	0,100	0,119
	$\delta_{N\infty}$ -factor	[mm/(N/mm <sup>2</sup> )]	0,081	0,090	0,108	0,127	0,145	0,172
<b>Cracked concrete C20/25 under static and quasi-static action</b>								
Temperature range I: 40°C/24°C	$\delta_{N0}$ -factor	[mm/(N/mm <sup>2</sup> )]	0,090	0,070				
	$\delta_{N\infty}$ -factor	[mm/(N/mm <sup>2</sup> )]	0,105	0,105				
Temperature range II: 80°C/50°C	$\delta_{N0}$ -factor	[mm/(N/mm <sup>2</sup> )]	0,219	0,170				
	$\delta_{N\infty}$ -factor	[mm/(N/mm <sup>2</sup> )]	0,255	0,245				
Temperature range III: 120°C/72°C	$\delta_{N0}$ -factor	[mm/(N/mm <sup>2</sup> )]	0,219	0,170				
	$\delta_{N\infty}$ -factor	[mm/(N/mm <sup>2</sup> )]	0,255	0,245				
<sup>1)</sup> Calculation of the displacement $\delta_{N0} = \delta_{N0}\text{-factor} \cdot \tau;$ $\tau$ : action bond stress for tension $\delta_{N\infty} = \delta_{N\infty}\text{-factor} \cdot \tau;$								
<b>Table C12: Displacements under shear load<sup>1)</sup> (Internal threaded anchor rod)</b>								
<b>Anchor size Internal threaded anchor rod</b>			<b>IG-M6</b>	<b>IG-M8</b>	<b>IG-M10</b>	<b>IG-M12</b>	<b>IG-M16</b>	<b>IG-M20</b>
<b>Non-cracked and cracked concrete C20/25 under static and quasi-static action</b>								
All temperature ranges	$\delta_{V0}$ -factor	[mm/kN]	0,07	0,06	0,06	0,05	0,04	0,04
	$\delta_{V\infty}$ -factor	[mm/kN]	0,10	0,09	0,08	0,08	0,06	0,06
<sup>1)</sup> Calculation of the displacement $\delta_{V0} = \delta_{V0}\text{-factor} \cdot V;$ $V$ : action shear load $\delta_{V\infty} = \delta_{V\infty}\text{-factor} \cdot V;$								
<b>EJOT Chemical Anchor MULTIFIX USF, MULTIFIX USF winter for concrete</b>							<b>Annex C 10</b>	
<b>Performances</b> Displacements (Internal threaded anchor rod)								

<b>Table C13: Displacements under tension load<sup>1)</sup> (rebar)</b>											
Anchor size reinforcing bar			Ø 8	Ø 10	Ø 12	Ø 14	Ø 16	Ø 20	Ø 25	Ø 28	Ø 32
<b>Non-cracked concrete C20/25 under static and quasi-static action</b>											
Temperature range I: 40°C/24°C	δ <sub>N0</sub> -factor	[mm/(N/mm <sup>2</sup> )]	0,021	0,023	0,026	0,028	0,031	0,036	0,043	0,047	0,052
	δ <sub>N∞</sub> -factor	[mm/(N/mm <sup>2</sup> )]	0,030	0,033	0,037	0,041	0,045	0,052	0,061	0,071	0,075
Temperature range II: 80°C/50°C	δ <sub>N0</sub> -factor	[mm/(N/mm <sup>2</sup> )]	0,050	0,056	0,063	0,069	0,075	0,088	0,104	0,113	0,126
	δ <sub>N∞</sub> -factor	[mm/(N/mm <sup>2</sup> )]	0,072	0,081	0,090	0,099	0,108	0,127	0,149	0,163	0,181
Temperature range III: 120°C/72°C	δ <sub>N0</sub> -factor	[mm/(N/mm <sup>2</sup> )]	0,050	0,056	0,063	0,069	0,075	0,088	0,104	0,113	0,126
	δ <sub>N∞</sub> -factor	[mm/(N/mm <sup>2</sup> )]	0,072	0,081	0,090	0,099	0,108	0,127	0,149	0,163	0,181
<b>Cracked concrete C20/25 under static and quasi-static action</b>											
Temperature range I: 40°C/24°C	δ <sub>N0</sub> -factor	[mm/(N/mm <sup>2</sup> )]	0,090						0,070		
	δ <sub>N∞</sub> -factor	[mm/(N/mm <sup>2</sup> )]	0,105						0,105		
Temperature range II: 80°C/50°C	δ <sub>N0</sub> -factor	[mm/(N/mm <sup>2</sup> )]	0,219						0,170		
	δ <sub>N∞</sub> -factor	[mm/(N/mm <sup>2</sup> )]	0,255						0,245		
Temperature range III: 120°C/72°C	δ <sub>N0</sub> -factor	[mm/(N/mm <sup>2</sup> )]	0,219						0,170		
	δ <sub>N∞</sub> -factor	[mm/(N/mm <sup>2</sup> )]	0,255						0,245		
<sup>1)</sup> Calculation of the displacement $\delta_{N0} = \delta_{N0\text{-factor}} \cdot \tau;$ $\tau$ : action bond stress for tension $\delta_{N\infty} = \delta_{N\infty\text{-factor}} \cdot \tau;$											
<b>Table C14: Displacement under shear load<sup>1)</sup> (rebar)</b>											
Anchor size reinforcing bar			Ø 8	Ø 10	Ø 12	Ø 14	Ø 16	Ø 20	Ø 25	Ø 28	Ø 32
<b>Non-cracked concrete C20/25 under static and quasi-static action</b>											
All temperature ranges	δ <sub>V0</sub> -factor	[mm/kN]	0,06	0,05	0,05	0,04	0,04	0,04	0,03	0,03	0,03
	δ <sub>V∞</sub> -factor	[mm/kN]	0,09	0,08	0,08	0,06	0,06	0,05	0,05	0,04	0,04
<b>Cracked concrete C20/25 under static and quasi-static action</b>											
All temperature ranges	δ <sub>V0</sub> -factor	[mm/kN]	0,12	0,12	0,11	0,11	0,10	0,09	0,08	0,07	0,06
	δ <sub>V∞</sub> -factor	[mm/kN]	0,18	0,18	0,17	0,16	0,15	0,14	0,12	0,11	0,10
<sup>1)</sup> Calculation of the displacement $\delta_{V0} = \delta_{V0\text{-factor}} \cdot V;$ $V$ : action shear load $\delta_{V\infty} = \delta_{V\infty\text{-factor}} \cdot V;$											
<b>EJOT Chemical Anchor MULTIFIX USF, MULTIFIX USF winter for concrete</b>									<b>Annex C 11</b>		
<b>Performances</b> Displacements (rebar)											

<b>Table C15: Characteristic values of tension loads under seismic action (performance category C1)</b>													
Anchor size threaded rod				M8	M10	M12	M16	M20	M24	M27	M30		
<b>Steel failure</b>													
Characteristic tension resistance		$N_{Rk,s,eq,C1}$	[kN]	$1,0 \cdot N_{Rk,s}$									
Partial factor		$\gamma_{Ms,N}$	[-]	see Table C1									
<b>Combined pull-out and concrete failure</b>													
Characteristic bond resistance in non-cracked and cracked concrete C20/25													
Temperature range	I: 40°C/24°C	Dry, wet concrete	$\tau_{Rk,eq,C1}$	[N/mm <sup>2</sup> ]	2,5	3,1	3,7	3,7	3,7	3,8	4,5	4,5	
	II: 80°C/50°C				1,6	2,2	2,7	2,7	2,7	2,8	3,1	3,1	
	III: 120°C/72°C				1,3	1,6	2,0	2,0	2,0	2,1	2,4	2,4	
	I: 40°C/24°C	flooded bore hole			2,5	2,5	3,7	3,7	No Performance Assessed				
	II: 80°C/50°C				1,6	1,9	2,7	2,7					
	III: 120°C/72°C				1,3	1,6	2,0	2,0					
Increasing factors for concrete $\psi_C$		C25/30 to C50/60		1,0									
<b>Installation factor</b>													
for dry and wet concrete		$\gamma_{inst}$	[-]	1,0	1,2								
for flooded bore hole				1,4				No Performance Assessed					
<b>Table C16: Characteristic values of shear loads under seismic action (performance category C1)</b>													
Anchor size threaded rod				M8	M10	M12	M16	M20	M24	M27	M30		
<b>Steel failure without lever arm</b>													
Characteristic shear resistance (Seismic C1)		$V_{Rk,s,eq,C1}$	[kN]	$0,70 \cdot V_{Rk,s}^0$									
Partial factor		$\gamma_{Ms,V}$	[-]	see Table C1									
<b>Factor for annular gap</b>		$\alpha_{gap}$	[-]	0,5 (1,0) <sup>1)</sup>									
<sup>1)</sup> Value in brackets valid for filled annular gap between anchor and clearance hole in the fixture. Use of special filling washer Annex A 3 is required													
<b>EJOT Chemical Anchor MULTIFIX USF, MULTIFIX USF winter for concrete</b>										<b>Annex C 12</b>			
<b>Performances</b> Characteristic values of tension loads and shear loads under seismic action (performance category C1)													

<b>Table C17: Characteristic values of tension loads under seismic action (performance category C1)</b>														
Anchor size reinforcing bar			Ø 8	Ø 10	Ø 12	Ø 14	Ø 16	Ø 20	Ø 25	Ø 28	Ø 32			
<b>Steel failure</b>														
Characteristic tension resistance	$N_{Rk,s,eq,C1}$	[kN]	$1,0 \cdot A_s \cdot f_{uk}^{1)}$											
Cross section area	$A_s$	[mm <sup>2</sup> ]	50	79	113	154	201	314	491	616	804			
Partial factor	$\gamma_{Ms,N}$	[-]	1,4 <sup>2)</sup>											
<b>Combined pull-out and concrete failure</b>														
Characteristic bond resistance in non-cracked and cracked concrete C20/25														
Temperature range	I: 40°C/24°C	Dry, wet concrete	$\tau_{Rk, eq,C1}$	[N/m <sup>2</sup> ]	2,5	3,1	3,7	3,7	3,7	3,7	3,8	4,5	4,5	
	II: 80°C/50°C				1,6	2,2	2,7	2,7	2,7	2,7	2,8	3,1	3,1	
	III: 120°C/72°C				1,3	1,6	2,0	2,0	2,0	2,0	2,1	2,4	2,4	
	I: 40°C/24°C	flooded bore hole			2,5	2,5	3,7	3,7	3,7	No Performance Assessed				
	II: 80°C/50°C				1,6	1,9	2,7	2,7	2,7					
	III: 120°C/72°C				1,3	1,6	2,0	2,0	2,0					
Increasing factors for concrete $\psi_c$		C25/30 to C50/60	1,0											
<b>Installation factor</b>														
for dry and wet concrete		$\gamma_{inst}$	[-]	1,2	1,2									
for flooded bore hole				1,4	No Performance Assessed									
<sup>1)</sup> $f_{uk}$ shall be taken from the specifications of reinforcing bars <sup>2)</sup> in absence of national regulation														
<b>Table C18: Characteristic values of shear loads under seismic action (performance category C1)</b>														
Anchor size reinforcing bar			Ø 8	Ø 10	Ø 12	Ø 14	Ø 16	Ø 20	Ø 25	Ø 28	Ø 32			
<b>Steel failure without lever arm</b>														
Characteristic shear resistance	$V_{Rk,s,eq,C1}$	[kN]	$0,35 \cdot A_s \cdot f_{uk}^{2)}$											
Cross section area	$A_s$	[mm <sup>2</sup> ]	50	79	113	154	201	314	491	616	804			
Partial factor	$\gamma_{Ms,V}$	[-]	1,5 <sup>2)</sup>											
Factor for annular gap	$\alpha_{gap}$	[-]	0,5 (1,0) <sup>3)</sup>											
<sup>1)</sup> $f_{uk}$ shall be taken from the specifications of reinforcing bars <sup>2)</sup> in absence of national regulation <sup>3)</sup> Value in brackets valid for filled annular gap between anchor and clearance hole in the fixture. Use of special filling washer Annex A 3 is required														
<b>EJOT Chemical Anchor MULTIFIX USF, MULTIFIX USF winter for concrete</b>										<b>Annex C 13</b>				
<b>Performances</b> Characteristic values of tension loads and shear loads under seismic action (performance category C1)														