

Approval body for construction products
and types of construction

Bautechnisches Prüfamt

An institution established by the Federal and
Laender Governments



European Technical Assessment

ETA-16/0515
of 23 August 2022

English translation prepared by DIBt - Original version in German language

General Part

Technical Assessment Body issuing the
European Technical Assessment:

Deutsches Institut für Bautechnik

Trade name of the construction product

HVU2

Product family
to which the construction product belongs

Bonded Fastener for use in concrete

Manufacturer

Hilti AG Liechtenstein
Feldkircherstraße 100
9494 Schaan
FÜRSTENTUM LIECHTENSTEIN

Manufacturing plant

Hilti Plants

This European Technical Assessment
contains

27 pages including 3 annexes which form an integral part
of this assessment

This European Technical Assessment is
issued in accordance with Regulation (EU)
No 305/2011, on the basis of

EAD 330499-01-0601 Edition 04/2020

This version replaces

ETA-16/0515 issued on 13 November 2019

The European Technical Assessment is issued by the Technical Assessment Body in its official language. Translations of this European Technical Assessment in other languages shall fully correspond to the original issued document and shall be identified as such.

Communication of this European Technical Assessment, including transmission by electronic means, shall be in full. However, partial reproduction may only be made with the written consent of the issuing Technical Assessment Body. Any partial reproduction shall be identified as such.

This European Technical Assessment may be withdrawn by the issuing Technical Assessment Body, in particular pursuant to information by the Commission in accordance with Article 25(3) of Regulation (EU) No 305/2011.

Specific Part

1 Technical description of the product

The HVU2 is a bonded anchor consisting of a mortar capsule Hilti HVU2 and a steel element. The steel element consists of

- an anchor rod Hilti HAS-U, HAS-U P or Hilti HAS-(E) with washer and hexagon nut of sizes M8 to M30 or
- an internally threaded sleeve HIS-(R)N of sizes M8 to M20.

The mortar capsule is placed in the hole and the steel element is driven by machine as specified in Annex B9.

The anchor rod is anchored via the bond between steel element, chemical mortar and concrete. The product description is given in Annex A.

2 Specification of the intended use in accordance with the applicable European Assessment Document

The performances given in Section 3 are only valid if the anchor is used in compliance with the specifications and conditions given in Annex B.

The verifications and assessment methods on which this European Technical Assessment is based lead to the assumption of a working life of the anchor of at least 50 years. The indications given on the working life cannot be interpreted as a guarantee given by the producer, but are to be regarded only as a means for choosing the right products in relation to the expected economically reasonable working life of the works.

3 Performance of the product and references to the methods used for its assessment

3.1 Mechanical resistance and stability (BWR 1)

Essential characteristic	Performance
Characteristic resistance to tension load (static and quasi-static loading)	See Annex C1 to C5, B3, B4
Characteristic resistance to shear load (static and quasi-static loading)	See Annex C6 to C8
Displacements for short-term and long-term loading	See Annex C9
Characteristic resistance and displacements for seismic performance categories C1 and C2	See Annex C10 and C11

3.2 Hygiene, health and the environment (BWR 3)

Essential characteristic	Performance
Content, emission and/or release of dangerous substances	No performance assessed

English translation prepared by DIBt

4 Assessment and verification of constancy of performance (AVCP) system applied, with reference to its legal base

In accordance with EAD 330499-01-0601 the applicable European legal act is: [96/582/EC].

The system to be applied is: 1

5 Technical details necessary for the implementation of the AVCP system, as provided for in the applicable European Assessment Document

Technical details necessary for the implementation of the AVCP system are laid down in the control plan deposited at Deutsches Institut für Bautechnik.

The following standards and documents are referred to in this European Technical Assessment:

- EN 1992-4:2018 Eurocode 2 - Design of concrete structures - Part 4: Design of fastenings for use in concrete
- EN 1993-1-4:2006 + A1:2015: Eurocode 3: Design of steel structures - Part 1-4: General rules - Supplementary rules for stainless steels
- EN 1998-1:2004 + AC:2009 Eurocode 8: Design of structures for earthquake resistance - Part 1: General rules, seismic actions and rules for buildings
- EN 10088-1:2014 Stainless steels - Part 1: List of stainless steels
- EN 206:2013 + A1:2016 Concrete - Specification, performance, production and conformity
- EN 10204:2004 Metallic products – Types of inspection documents
- DIN 488-1:2009-08 Reinforcing steels – Part 1: Grades, properties, marking
- EOTA TR 055: Design of fastenings based on EAD 330232-00-0601, EAD 330499-00-0601 and EAD 330747-00-0601, February 2018

Issued in Berlin on 23 August 2022 by Deutsches Institut für Bautechnik

Dipl.-Ing. Wittstock
Referatsleiterin

beglaubigt:
Stiller

Installed condition

Figure A1:
HAS-U..., HAS-U...P

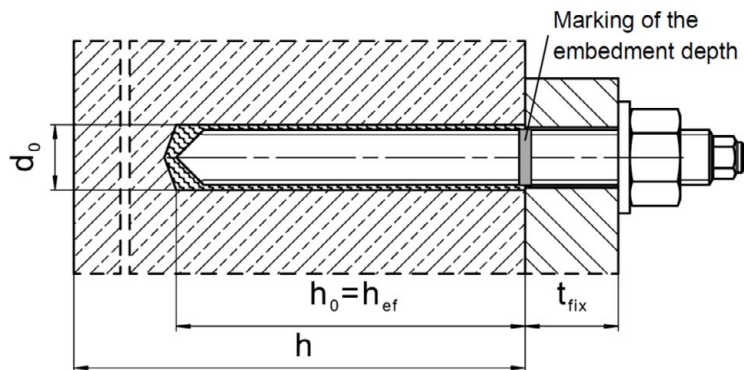

HAS-(E)...

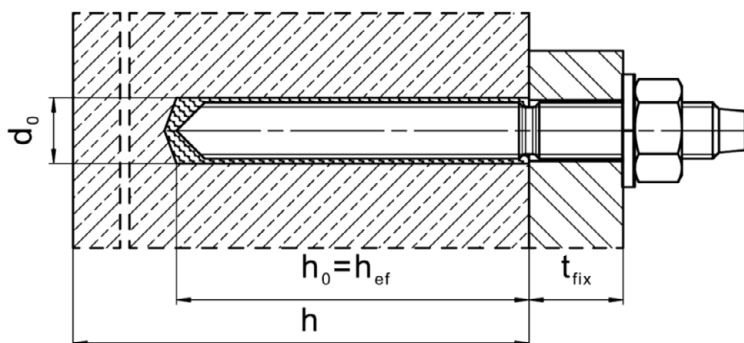
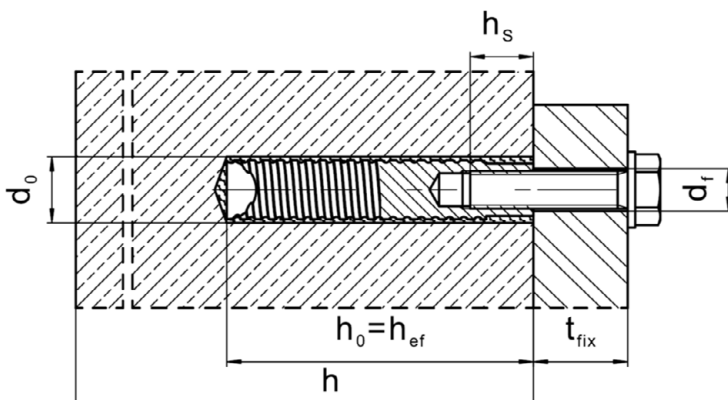

Figure A2:
Internally threaded sleeve HIS-(R)N



HVU2

Product description
Installation condition

Annex A1

Product description: Mortar capsule and steel elements

Adhesive anchor capsule HVU2 M8 to M30: resin and hardener with aggregate

Marking: _____ →
HVU2
Expiry date mm/yyyy
Product name: "HVU2"



Steel elements

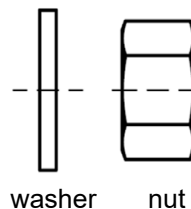
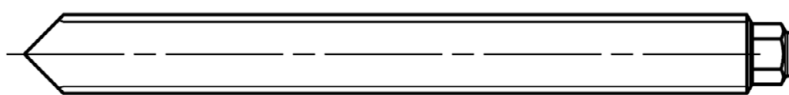

HAS-U-...: M8 to M30

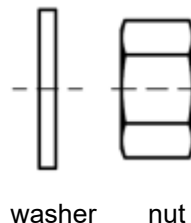
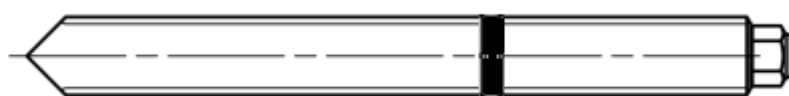

HAS-U-...P: M8 to M24

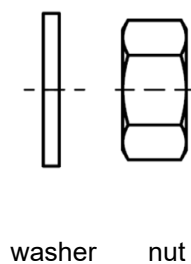
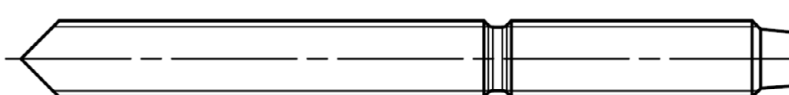

HAS-(E)...: M8 to M30



Internally threaded sleeve: HIS-(R)N M8 to M20

HVU2

Product description

Adhesive anchor capsule / Steel elements

Annex A2

Table A1: Materials

Designation	Material
Steel elements made of zinc coated steel	
HAS-U 5.8 (HDG) HAS-U 5.8 (HDG) P	Strength class 5.8, $f_{uk} = 500 \text{ N/mm}^2$, $f_{yk} = 400 \text{ N/mm}^2$, Elongation at fracture ($l_0=5 \cdot d$) > 8% ductile Electroplated zinc coated $\geq 5 \mu\text{m}$, (HDG) hot dip galvanized $\geq 45 \mu\text{m}$
HAS-U 8.8 (HDG) HAS-U 8.8 (HDG) P	Strength class 8.8, $f_{uk} = 800 \text{ N/mm}^2$, $f_{yk} = 640 \text{ N/mm}^2$, Elongation at fracture ($l_0=5 \cdot d$) > 12% ductile Electroplated zinc coated $\geq 5 \mu\text{m}$, (F) or (HDG) hot dip galvanized $\geq 45 \mu\text{m}$
HAS-(E)-(F)	M8 to M16: Strength class 5.8, $f_{uk} = 570 \text{ N/mm}^2$, $f_{yk} = 456 \text{ N/mm}^2$. M20 and M24: Strength class 5.8, $f_{uk} = 500 \text{ N/mm}^2$, $f_{yk} = 400 \text{ N/mm}^2$. Elongation at fracture ($l_0=5 \cdot d$) > 8% ductile. M8 to M30: Strength class 8.8, $f_{uk} = 800 \text{ N/mm}^2$, $f_{yk} = 640 \text{ N/mm}^2$. Elongation at fracture ($l_0=5 \cdot d$) > 12% ductile . Electroplated zinc coated $\geq 5 \mu\text{m}$, (F) hot dip galvanized $\geq 45 \mu\text{m}$.
Internally threaded sleeve HIS-N	Electroplated zinc coated $\geq 5 \mu\text{m}$
Washer	Electroplated zinc coated $\geq 5 \mu\text{m}$, hot dip galvanized $\geq 45 \mu\text{m}$
Nut	Strength class of nut adapted to strength class of threaded rod Electroplated zinc coated $\geq 5 \mu\text{m}$, (F) hot dip galvanized $\geq 45 \mu\text{m}$
Steel elements made of stainless steel corrosion resistance class (CRC) III according EN 1993-1-4	
HAS-U A4 HAS-U A4 P	For \leq M24: strength class 70, $f_{uk} = 700 \text{ N/mm}^2$, $f_{yk} = 450 \text{ N/mm}^2$; For $>$ M24: strength class 50, $f_{uk} = 500 \text{ N/mm}^2$, $f_{yk} = 210 \text{ N/mm}^2$; Elongation at fracture ($l_0=5 \cdot d$) > 12% ductile
HAS-(E)-R	M8 to M16: Strength class 70, $f_{uk} = 700 \text{ N/mm}^2$, $f_{yk} = 500 \text{ N/mm}^2$. M20 and M24: Strength class 70, $f_{uk} = 700 \text{ N/mm}^2$, $f_{yk} = 450 \text{ N/mm}^2$. M27 and M30: Strength class 50, $f_{uk} = 500 \text{ N/mm}^2$, $f_{yk} = 210 \text{ N/mm}^2$. Elongation at fracture ($l_0=5 \cdot d$) > 8% ductile.
Internally threaded sleeve HIS-(R)N	Stainless steel 1.4401, 1.4571 EN 10088-1
Washer	Stainless steel 1.4401, 1.4404, 1.4578, 1.4571, 1.4439, 1.4362 EN 10088-1
Nut	For \leq M24: strength class 70, $f_{uk} = 700 \text{ N/mm}^2$, $f_{yk} = 450 \text{ N/mm}^2$; For $>$ M24: strength class 50, $f_{uk} = 500 \text{ N/mm}^2$, $f_{yk} = 210 \text{ N/mm}^2$; Stainless steel 1.4401, 1.4404, 1.4578, 1.4571, 1.4439, 1.4362 EN 10088-1
Steel elements made of high corrosion resistant steel corrosion resistance class (CRC) V according EN 1993-1-4	
HAS-(E)-HCR HAS-U HCR	For \leq M20: $f_{uk} = 800 \text{ N/mm}^2$, $f_{yk} = 640 \text{ N/mm}^2$, For $>$ M20: $f_{uk} = 700 \text{ N/mm}^2$, $f_{yk} = 400 \text{ N/mm}^2$, Elongation at fracture ($l_0=5 \cdot d$) > 12% ductile
Washer	High corrosion resistant steel 1.4529, 1.4565 EN 10088-1
Nut	For \leq M20: $f_{uk} = 800 \text{ N/mm}^2$, $f_{yk} = 640 \text{ N/mm}^2$, For $>$ M20: $f_{uk} = 700 \text{ N/mm}^2$, $f_{yk} = 400 \text{ N/mm}^2$, High corrosion resistant steel 1.4529, 1.4565 EN 10088-1

HVU2

Product description
Materials

Annex A3

Specifications of intended use

Anchorage subject to:

- Static and quasi static loading.
- Seismic performance category C1: HAS-U... and HAS-(E)... size M10 to M30.
- Seismic performance category C1: HAS-U...P size M10 to M24.
- Seismic performance category C2: HAS-U..., HAS-U...P and HAS-(E)... size M16 and M20.







Base material:

- Compacted reinforced or unreinforced normal weight concrete without fibres according to EN 206.
- Strength classes C20/25 to C50/60 according to EN 206.
- Cracked and uncracked concrete.

Temperature in the base material:

- **at installation**
-10 °C to +40 °C
for the standard variation of temperature and rapid variation of temperature after installation
- **in-service**
Temperature range I: -40 °C to +40 °C
(max. long term temperature +24 °C and max. short term temperature +40 °C)
Temperature range II: -40 °C to +80 °C
(max. long term temperature +50 °C and max. short term temperature +80 °C)
Temperature range III: -40 °C to +120 °C
(max. long term temperature +72 °C and max. short term temperature +120 °C)

Table B1: Specifications of intended use

		Foil capsule HVU2 with ...		
Steel elements		HAS-U..., HAS-(E)...	HAS-U...P	HIS-(R)N
Hammer drilling with hollow drill bit TE-CD or TE-YD		M10 to M30 	M10 to M24 	M8 to M20 
Hammer drilling		M8 to M30	M8 to M24	M8 to M20
Diamond drilling		M10 to M30	M10 to M24	M8 to M20

HVU2

Intended Use
Specifications

Annex B1

Use conditions (Environmental conditions):

- Structures subject to dry internal conditions (all materials).
- For all other conditions according EN 1993-1-4 corresponding to corrosion resistance classes Annex A3 Table A1 (stainless steels).

Design:

- Fastenings are designed under the responsibility of an engineer experienced in fastenings and concrete work.
- Verifiable calculation notes and drawings are prepared taking account of the loads to be fastened. The position of the fastener is indicated on the design drawings (e. g. position of the fastener relative to reinforcement or to supports, etc.).
- The fastenings are designed in accordance with:
EN 1992-4 and EOTA Technical Report TR 055.

Installation:

- Use category: dry or wet concrete (not in flooded holes) for all drilling techniques.
- Drilling technique:
 - Hammer drilling,
 - Hammer drilling with Hilti hollow drill bit TE-CD, TE-YD,
 - Diamond coring (e.g. Hilti DD 30-W or other Hilti DD machines).
- Installation direction
D2: downward and horizontal installation for HVU2 M8 to M30.
D3: downward and horizontal and upward (e.g. overhead) installation for HVU2 M8 to M24.
- Fastener installation carried out by appropriately qualified personnel and under the supervision of the person responsible for technical matters of the site.

HVU2	Annex B2
Intended Use Specifications	

Table B2: Installation parameters of HAS-U..., HAS-U...P and HAS-(E)...

HAS-U..., HAS-U...P and HAS-(E)...			M8	M10	M12	M16	M20	M24	M27	M30
Foil capsule HVU2 M...	h_{ef1}	[-]	8x80	10x90	12x110	16x125	20x170	24x210	27x240	30x270
	h_{ef2}	[-]	-	10x135	12x165	16x190	-	-	-	-
Diameter of fastener	$d = d_{nom}$	[mm]	8	10	12	16	20	24	27	30
Nominal diameter of drill bit	d_0	[mm]	10	12	14	18	22	28	30	35
Effective embedment depth and drill hole depth	$h_{ef1} = h_{0,1}$	[mm]	80	90	110	125	170	210	240	270
	$h_{ef2} = h_{0,2}$	[mm]	-	135	165	190	-	-	-	-
Maximum diameter of clearance hole in the fixture	d_f	[mm]	9	12	14	18	22	26	30	33
Minimum thickness of concrete member	h_{min1}	[mm]	110	120	140	160	220	270	300	340
	h_{min2}	[mm]	-	165	195	230	-	-	-	-
Maximum torque moment	T_{max}	[Nm]	10	20	40	80	150	200	270	300
Minimum spacing	s_{min}	[mm]	40	50	60	75	90	115	120	140
Minimum edge distance	c_{min}	[mm]	40	45	45	50	55	60	75	80

HAS-U...



Marking:

Steel grade number (and length identification letter: e.g. 8L)

HAS-U...P

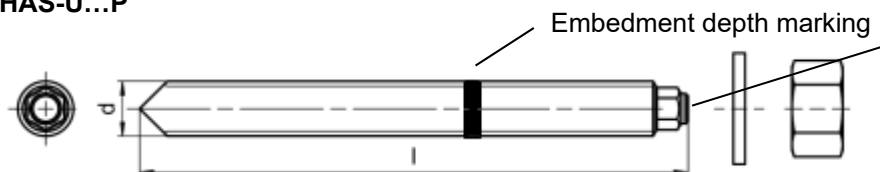

Marking:

Steel grade number (and length identification letter: e.g. 8L)

HAS-(E)...

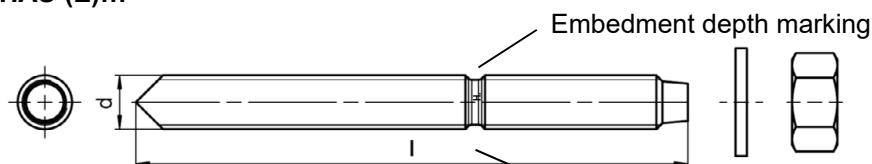

Marking:

identifying mark - H, embossing "1" HAS-(E)
 identifying mark - H, embossing "=" HAS-(E)R
 identifying mark - H, embossing "CR" HAS-(E)HCR

HVU2

Intended Use

Installation parameters of HAS-U..., HAS-U...P and HAS-(E)...

Annex B3

Table B3: Installation parameters of internally threaded sleeve HIS-(R)N

Internally threaded sleeve HIS-(R)N...		M8	M10	M12	M16	M20
Foil capsule HVU2 M...		10x90	12x110	16x125	20x170	24x210
Outer diameter of sleeve	d [mm]	12,5	16,5	20,5	25,4	27,8
Nominal diameter of drill bit	d ₀ [mm]	14	18	22	28	32
Effective embedment depth and drill hole depth	h _{ef} = h ₀ [mm]	90	110	125	170	205
Maximum diameter of clearance hole in the fixture	d _f [mm]	9	12	14	18	22
Minimum thickness of concrete member	h _{min} [mm]	120	150	170	230	270
Maximum installation torque	max T _{inst} [Nm]	10	20	40	80	150
Thread engagement length min-max	h _s [mm]	8-20	10-25	12-30	16-40	20-50
Minimum spacing	s _{min} [mm]	60	75	90	115	130
Minimum edge distance	c _{min} [mm]	40	45	55	65	90

Internally threaded sleeve HIS-(R)N...

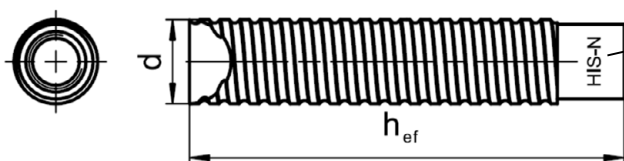

Marking:

Identifying mark - HILTI and embossing "HIS-N" (for C-steel) embossing "HIS-RN" (for stainless steel)

Table B4: Minimum curing time

Temperature in the base material T	Minimum curing time t _{cure}
-10 °C to -6 °C	5 hours
-5 °C to -1 °C	3 hours
0 °C to 4 °C	40 min
5 °C to 9 °C	20 min
10 °C to 19 °C	10 min
20 °C to 40 °C	5 min







HVU2

Intended Use

Installation parameters of internally threaded sleeve HIS-(R)N
Minimum curing time



Annex B4

Table B5: Parameters of drilling and cleaning tools

Elements		Drill and clean			
HAS-U..., HAS-U...P, HAS-(E)...	HIS-(R)N	Hammer drilling		Diamond coring	Brush
			Hollow drill bit ¹⁾ TE-CD, TE-YD		
					
Size	Name	d ₀ [mm]	d ₀ [mm]	d ₀ [mm]	HIT-RB
M8	-	10	-	-	-
M10	-	12	12	12	12
M12	M8	14	14	14	14
M16	M10	18	18	18	18
M20	M12	22	22	22	22
M24	M16	28	28	28	28
M27	-	30	-	30	30
-	M20	32	32	32	32
M30	-	35	35	35	35

¹⁾ With vacuum cleaner Hilti VC 20/40/60 (automatic filter cleaning activated) or vacuum cleaner with activated automatic filter cleaning as well as volumetric flow rate at turbine ≥ 57 l/s, volumetric flow rate at end of hose ≥ 106 m³/h and partial vacuum ≥ 16 kPa.

Cleaning alternatives







<p>Manual Cleaning (MC): Hilti hand pump for blowing out drill holes with diameters $d_0 \leq 18$ mm and drill hole depths $h_0 \leq 10 \cdot d$.</p>	
<p>Compressed air cleaning (CAC): Air nozzle with an orifice opening of minimum 3,5 mm in diameter.</p>	
<p>Automatic Cleaning (AC): Cleaning is performed during drilling with Hilti TE-CD and TE-YD drilling system including vacuum cleaner.</p>	

HVU2







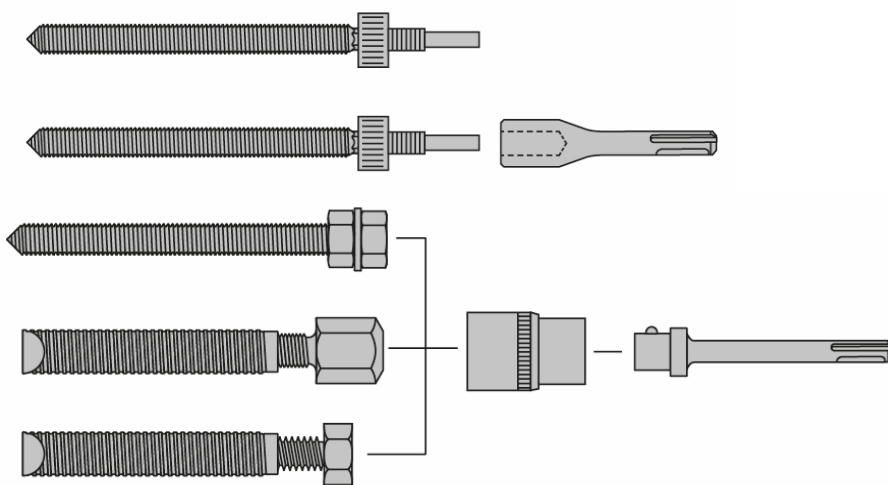

Intended Use
Parameters of drilling and cleaning tools
Cleaning alternatives

Annex B5

Table B6: Parameters of setting tools HAS-U..., HAS-U...P, HAS-(E)... and HIS-(R)N

HAS	HIS-N	HVU2	TE(A)	SID 4-A22	SIW 22T-A	SF(H)	RPM
							
M8	-	M8x80	1...7	+	+	2, 6, 8, 10, 14, 22	450...1300
M10	M8	M10x90	1...7	+	+	6, 8, 10, 14, 22	450...1300
M10	-	M10x135	1...40	-	-	6, 8, 10, 14, 22	450...1300
M12	M10	M12x110	1...40	+	+	6, 8, 10, 14, 22	450...1300
M12	-	M12x165	1...40	-	-	6, 8, 10, 14, 22	450...1300
M16	M12	M16x125	1...40	+	-	6, 8, 10, 14, 22	450...1300
M16	-	M16x190	50...80	-	-	-	-
M20	-	M20x170	50...60	-	-	-	-
-	M16	M20x170	40...80	-	-	-	-
M24	-	M24x210	50...80	-	-	-	-
-	M20	M24x210	40...80	-	-	-	-
M27	-	M27x240	60...80	-	-	-	-
M30	-	M30x270	60...80	-	-	-	-



Setting tool		Article number	TE (A) 1...40	TE 50...80	SF (H)	SID 4-A22	HIS-S 
-		-	-	-	+	-	-
TE-C HVU2		# 2181356	+	-	-	-	-
TE-Y HVU2		# 2230162...5	-	+	-	-	-
TE-C 1/2"		# 32220	+	-	-	-	+
TE-Y 3/4"		# 32221	-	+	-	-	+
SI-SA 1/4" - 1/2"		# 2077174	-	-	+	+	+
SI-SA 7/16"		# 2134075	-	-	+	-	+

HVU2

Intended Use
Parameters of setting tools

Annex B6

Installation instruction

Hole drilling

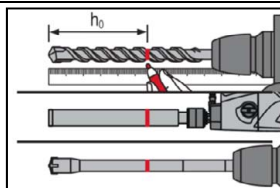

Mark required drilling depth h_0 on drill bit or core bit.

a) Hammer drilling: For dry and wet concrete

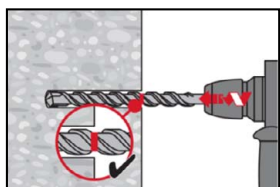

Drill hole to the required embedment depth with a hammer drill set in rotation-hammer mode using an appropriately sized carbide drill bit.

b) Hammer drilling with Hilti hollow drill bit: For dry and wet concrete

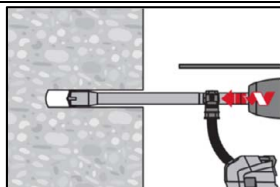

Drill hole to the required embedment depth with an appropriately sized Hilti TE-CD or TE-YD hollow drill bit attached to Hilti vacuum cleaner. This drilling system removes the dust and cleans the drill hole during drilling when used in accordance with the user's manual. After drilling is completed, proceed to the "setting the element" step in the installation instruction.

c) Diamond coring: For dry and wet concrete

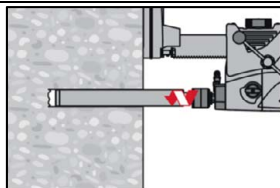

Diamond coring is permissible when suitable diamond core drilling machines and the corresponding core bits are used.

Check setting depth

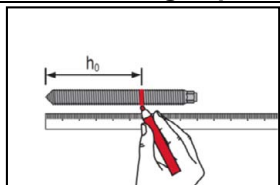

Mark required anchorage depth on fastener (see Table B2).

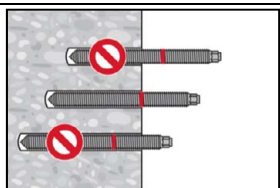

Check the setting depth with the marked element.
The element has to fit in the hole until the required embedment depth, not deeper.
If it is not possible to insert the element to the required embedment depth, drill deeper.

HVU2

Intended Use
Installation instructions

Annex B7

Drill hole cleaning: Just before injection of the mortar, the drill hole must be free of dust and debris. Inadequate hole cleaning = poor load values.

Manual Cleaning (MC): For drill hole diameters $d_0 \leq 18$ mm and drill hole depths $h_0 \leq 10 \cdot d$.

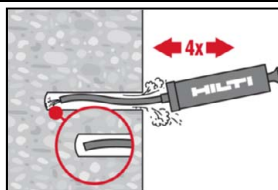

The Hilti hand pump may be used for blowing out drill holes. Blow out at least 4 times from the back of the drill hole until return air stream is free of noticeable dust.

Compressed Air Cleaning (CAC): For all drill hole diameters d_0 and all drill hole depths h_0 .

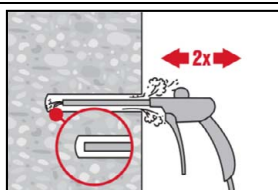

Blow 2 times from the back of the hole (if needed with nozzle extension) over the whole length with oil-free compressed air (min. 6 bar at 6 m³/h) until return air stream is free of noticeable dust.

Cleaning of hammer drilled flooded holes and diamond cored holes:

For all drill hole diameters d_0 and all drill hole depths h_0 .

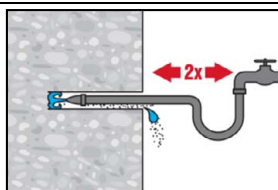

Flush 2 times by inserting a water hose (water-line pressure) to the back of the hole until water runs clear.

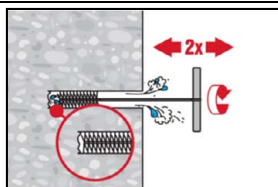

Brush 2 times with the specified brush (Table B5) by inserting the steel brush Hilti HIT-RB to the back of the hole (if needed with extension) in a twisting motion and removing it. The brush must produce natural resistance as it enters the drill hole (brush $\varnothing \geq$ drill hole \varnothing) - if not, the brush is too small and must be replaced with the proper brush diameter.

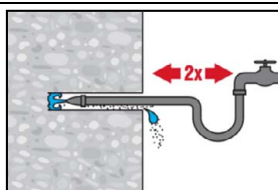

Flush 2 times by inserting a water hose (water-line pressure) to the back of the hole until water runs clear.

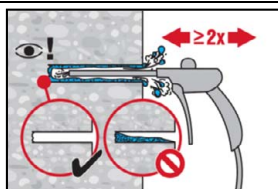

Blow 2 times from the back of the hole (if needed with nozzle extension) over the whole length with oil-free compressed air (min. 6 bar at 6 m³/h) until return air stream is free of noticeable dust and water.

HVU2

Intended Use
Installation instructions

Annex B8

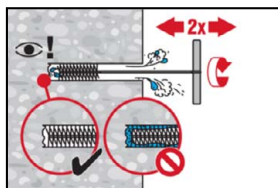

Brush 2 times with the specified brush (see Table B5) by inserting the steel brush Hilti HIT-RB to the back of the hole (if needed with extension) in a twisting motion and removing it.
The brush must produce natural resistance as it enters the drill hole (brush $\varnothing \geq$ drill hole \varnothing) - if not, the brush is too small and must be replaced with the proper brush diameter.

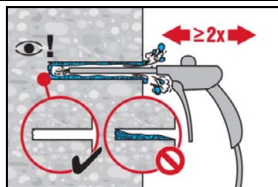

Blow again with compressed air 2 times until return air stream is free of noticeable dust and water.

Setting the element

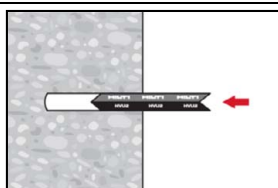

Insert the foil capsule with the peak ahead to the back of the hole.

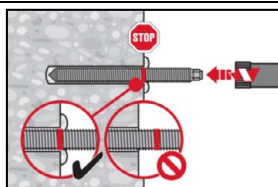

Drive the anchor rod with the plugged tool into the hole, applying moderate pressure. Rotary hammer tool in rotation hammer mode (450 RPM to maximum 1300 RPM).
Setting tool see Annex B6.
After reaching the embedment depth switch off setting machine immediately.

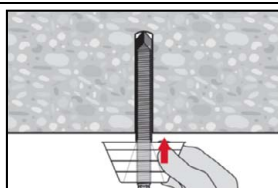

Overhead installation for HVU2 M8 to M24.
For overhead installation use the overhead dripping cup HIT-OHC.

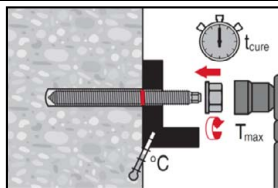

Loading the anchor: After required curing time t_{cure} (see Table B4) the anchor can be loaded.
The applied installation torque shall not exceed the values T_{inst} given in Table B2 and Table B3.

HVU2

Intended Use
Installation instructions

Annex B9

Table C1: Essential characteristics for HAS-U..., HAS-U...P and HAS-(E) under tension load in concrete

HAS-U..., HAS-U...P and HAS-(E)...		M8	M10	M12	M16	M20	M24	M27	M30	
Installation factor										
Hammer drilling and Hilti hollow drill bit TE-CD or TE-YD	γ_{inst}	[-]								1,0
Diamond coring	γ_{inst}	3)				1,0				
Steel failure HAS-(E)...										
Characteristic resistance HAS-(E) 5.8	$N_{Rk,s}$	[kN]	18,9	30,1	43,4	82,2	112,2	160,2	2)	
Partial factor	$\gamma_{Ms,N}^{1)}$	[-]				1,50				2)
Characteristic resistance HAS-(E) 8.8	$N_{Rk,s}$	[kN]	26,5	42,2	61,0	115,4	179,5	256,4	347	421,5
Partial factor	$\gamma_{Ms,N}^{1)}$	[-]								1,50
Characteristic resistance HAS-(E) R	$N_{Rk,s}$	[kN]	23,2	37,0	53,3	100,9	157,0	224,3	216,9	263,4
Partial factor	$\gamma_{Ms,N}^{1)}$	[-]		1,68		1,87		2,86		
Characteristic resistance HAS-(E) HCR	$N_{Rk,s}$	[kN]	26,5	42,2	61,0	115,4	179,5	224,3	2)	
Partial factor	$\gamma_{Ms,N}^{1)}$	[-]		1,50		2,10		2)		
Steel failure HAS-U... and HAS-U...P										
Characteristic resistance HAS-U...(P)	$N_{Rk,s}$	[kN]	$A_s \cdot f_{uk}$							
Partial factor HAS-U 5.8 (P)	$\gamma_{Ms,N}^{1)}$	[-]				1,50		2)		
Partial factor HAS-U 8.8 (P)	$\gamma_{Ms,N}^{1)}$	[-]								1,50
Partial factor HAS-U A4 (P)	$\gamma_{Ms,N}^{1)}$	[-]				1,87		2,86		
Partial factor HAS-U HCR (P)	$\gamma_{Ms,N}^{1)}$	[-]		1,50		2,10		2)		

HVU2

Performance

Essential characteristics under tension loads in concrete

Annex C1

Table C1: continued

HAS-U..., HAS-U...P and HAS-(E)...		M8	M10	M12	M16	M20	M24	M27	M30
Combined pullout and concrete cone failure									
Effective embedment depth	h_{ef1} [mm]	80	90	110	125	170	210	240	270
	h_{ef2} [mm]	2)	135	165	190	2)	2)	2)	2)
Characteristic bond resistance in uncracked concrete C20/25 in hammer drilled holes									
Temperature range I: 24 °C / 40 °C	$\tau_{Rk,ucr}$ [N/mm ²]	12,0	16,0						
Temperature range II: 50 °C / 80 °C	$\tau_{Rk,ucr}$ [N/mm ²]	9,5	13,0						
Temperature range III: 72 °C / 120 °C	$\tau_{Rk,ucr}$ [N/mm ²]	6,0	7,5						
Characteristic bond resistance in uncracked concrete C20/25 in hammer drilled holes with hollow drill bit TE-CD or TE-YD									
Temperature range I: 24 °C / 40 °C	$\tau_{Rk,ucr}$ [N/mm ²]	3)	16,0						
Temperature range II: 50 °C / 80 °C	$\tau_{Rk,ucr}$ [N/mm ²]	3)	13,0						
Temperature range III: 72 °C / 120 °C	$\tau_{Rk,ucr}$ [N/mm ²]	3)	7,5						
Characteristic bond resistance in uncracked concrete C20/25 in diamond cored holes									
Temperature range I: 24 °C / 40 °C	$\tau_{Rk,ucr}$ [N/mm ²]	3)	14,0						
Temperature range II: 50 °C / 80 °C	$\tau_{Rk,ucr}$ [N/mm ²]	3)	12,0						
Temperature range III: 72 °C / 120 °C	$\tau_{Rk,ucr}$ [N/mm ²]	3)	6,5						
Characteristic bond resistance in cracked concrete C20/25 in hammer drilled holes									
Temperature range I: 24 °C / 40 °C	$\tau_{Rk,cr}$ [N/mm ²]	5,0	8,5						
Temperature range II: 50 °C / 80 °C	$\tau_{Rk,cr}$ [N/mm ²]	4,0	6,5						
Temperature range III: 72 °C / 120 °C	$\tau_{Rk,cr}$ [N/mm ²]	2,5	4,0						
Characteristic bond resistance in cracked concrete C20/25 in hammer drilled holes with hollow drill bit TE-CD or TE-YD									
Temperature range I: 24 °C / 40 °C	$\tau_{Rk,cr}$ [N/mm ²]	3)	8,5						
Temperature range II: 50 °C / 80 °C	$\tau_{Rk,cr}$ [N/mm ²]	3)	6,5						
Temperature range III: 72 °C / 120 °C	$\tau_{Rk,cr}$ [N/mm ²]	3)	4,0						
Characteristic bond resistance in cracked concrete C20/25 in diamond cored holes									
Temperature range I: 24 °C / 40 °C	$\tau_{Rk,cr}$ [N/mm ²]	3)	7,0						
Temperature range II: 50 °C / 80 °C	$\tau_{Rk,cr}$ [N/mm ²]	3)	6,0						
Temperature range III: 72 °C / 120 °C	$\tau_{Rk,cr}$ [N/mm ²]	3)	3,5						

HVU2

Performance

Essential characteristics under tension loads in concrete

Annex C2

Table C1: continued

HAS-U..., HAS-U...P and HAS-(E)...				M8	M10	M12	M16	M20	M24	M27	M30
Influence factors ψ on bond resistance τ_{Rk}											
Hammer drilled holes and hammer drilled holes with hollow drill bit TE-CD or TE-YD											
Influence of concrete strength class: $\tau_{Rk} = \tau_{Rk,(C20/25)} \cdot \psi_c$											
Temperature range I – III	uncracked concrete	ψ_c	[-]	$(f_{ck}/20)^{0,2}$							
	cracked concrete	ψ_c	[-]	$(f_{ck}/20)^{0,1}$							
Influence of sustained load in cracked and uncracked concrete											
Temperature range I: 24 °C / 40 °C		ψ_{sus}^0	[-]	1,00							
Temperature range II: 50 °C / 80 °C		ψ_{sus}^0	[-]	0,73							
Temperature range III: 72 °C / 120 °C		ψ_{sus}^0	[-]	0,73							
Diamond cored holes											
Influence of concrete strength class: $\tau_{Rk} = \tau_{Rk,(C20/25)} \cdot \psi_c$											
Temperature range I – III	uncracked concrete	ψ_c	[-]	$(f_{ck}/20)^{0,2}$							
	cracked concrete	ψ_c	[-]	1,00							
Influence of sustained load in cracked and uncracked concrete											
Temperature range I: 24 °C / 40 °C		ψ_{sus}^0	[-]	0,78							
Temperature range II: 50 °C / 80 °C		ψ_{sus}^0	[-]	0,71							
Temperature range III: 72 °C / 120 °C		ψ_{sus}^0	[-]	0,78							
Concrete cone failure											
Factor for uncracked concrete		$k_{ucr,N}$	[-]	11,0							
Factor for cracked concrete		$k_{cr,N}$	[-]	7,7							
Edge distance		$c_{cr,N}$	[mm]	$1,5 \cdot h_{ef}$							
Spacing		$s_{cr,N}$	[mm]	$3,0 \cdot h_{ef}$							
Splitting failure											
Edge distance $c_{cr,sp}$ [mm] for	$h / h_{ef} \geq 2,0$			$1,0 \cdot h_{ef}$							
	$2,0 > h / h_{ef} > 1,3$			$4,6 h_{ef} - 1,8 h$							
	$h / h_{ef} \leq 1,3$			$2,26 h_{ef}$							
Spacing		$s_{cr,sp}$	[mm]	$2 \cdot c_{cr,sp}$							

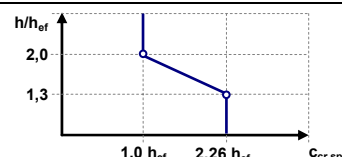

- 1) In absence of national regulations.
- 2) Fastener size not available
- 3) Performance not assessed.

HVU2

Performance
Essential characteristics under tension loads in concrete

Annex C3

Table C2: Essential characteristics for internally threaded sleeve HIS-(R)N under tension load in concrete

HIS-(R)N			M8	M10	M12	M16	M20
Installation factor							
Hammer drilling and Hilti hollow drill bit TE-CD or TE-YD	γ_{inst}	[-]	1,0				
Diamond coring	γ_{inst}	[-]	1,0				
Steel failure							
Characteristic resistance HIS-N with screw or threaded rod grade 8.8	$N_{Rk,s}$	[kN]	25	46	67	125	116
Partial factor	$\gamma_{Ms,N}^{1)}$	[-]	1,50				
Characteristic resistance HIS-RN with screw or threaded rod grade 70	$N_{Rk,s}$	[kN]	26	41	59	110	166
Partial factor	$\gamma_{Ms,N}^{1)}$	[-]	1,87				2,40
Combined pullout and concrete cone failure							
Effective embedment depth	h_{ef}	[mm]	90	110	125	170	205
Effective diameter of fastener	d	[mm]	12,5	16,5	20,5	25,4	27,8
Characteristic bond resistance in uncracked concrete C20/25 in hammer drilled holes and hammer drilled holes with hollow drill bit TE-CD or TE-YD							
Temperature range I: 24 °C / 40 °C	$\tau_{Rk,ucr}$	[N/mm ²]	11,0				
Temperature range II: 50 °C / 80 °C	$\tau_{Rk,ucr}$	[N/mm ²]	9,0				
Temperature range III: 72 °C / 120 °C	$\tau_{Rk,ucr}$	[N/mm ²]	5,5				
Characteristic bond resistance in uncracked concrete C20/25 in diamond cored holes							
Temperature range I: 24 °C / 40 °C	$\tau_{Rk,ucr}$	[N/mm ²]	11,0				
Temperature range II: 50 °C / 80 °C	$\tau_{Rk,ucr}$	[N/mm ²]	9,0				
Temperature range III: 72 °C / 120 °C	$\tau_{Rk,ucr}$	[N/mm ²]	5,5				
Characteristic bond resistance in cracked concrete C20/25 in hammer drilled holes and hammer drilled holes with hollow drill bit TE-CD or TE-YD							
Temperature range I: 24 °C / 40 °C	$\tau_{Rk,cr}$	[N/mm ²]	6,5				
Temperature range II: 50 °C / 80 °C	$\tau_{Rk,cr}$	[N/mm ²]	5,0				
Temperature range III: 72 °C / 120 °C	$\tau_{Rk,cr}$	[N/mm ²]	3,0				
Characteristic bond resistance in cracked concrete C20/25 in diamond cored holes							
Temperature range I: 24 °C / 40 °C	$\tau_{Rk,cr}$	[N/mm ²]	4,5				
Temperature range II: 50 °C / 80 °C	$\tau_{Rk,cr}$	[N/mm ²]	3,5				
Temperature range III: 72 °C / 120 °C	$\tau_{Rk,cr}$	[N/mm ²]	2,5				

HVU2

Performance

Essential characteristics under tension loads in concrete

Annex C4

Table C2: continued

HIS-IN		M8	M10	M12	M16	M20
Influence factors ψ on bond resistance τ_{Rk}						
Hammer drilled holes and hammer drilled holes with hollow drill bit TE-CD or TE-YD						
Influence of concrete strength class: $\tau_{Rk} = \tau_{Rk,(C20/25)} \cdot \psi_c$						
Temperature range I – III	uncracked concrete	ψ_c	[-]	1,00		
	cracked concrete	ψ_c	[-]	$(f_{ck}/20)^{0,2}$		
Influence of sustained load in cracked and uncracked concrete						
Temperature range I: 24 °C / 40 °C		ψ_{sus}^0	[-]	1,0		
Temperature range II: 50 °C / 80 °C		ψ_{sus}^0	[-]	0,73		
Temperature range III: 72 °C / 120 °C		ψ_{sus}^0	[-]	0,73		
Diamond cored holes						
Influence of concrete strength class: $\tau_{Rk} = \tau_{Rk,(C20/25)} \cdot \psi_c$						
Temperature range I – III	uncracked concrete	ψ_c	[-]	1,00		
	cracked concrete	ψ_c	[-]	1,00		
Influence of sustained load in cracked and uncracked concrete						
Temperature range I: 24 °C / 40 °C		ψ_{sus}^0	[-]	0,78		
Temperature range II: 50 °C / 80 °C		ψ_{sus}^0	[-]	0,71		
Temperature range III: 72 °C / 120 °C		ψ_{sus}^0	[-]	0,78		
Concrete cone failure						
Factor for uncracked concrete		$k_{ucr,N}$	[-]	11		
Factor for cracked concrete		$k_{cr,N}$	[-]	7,7		
Edge distance		$c_{cr,N}$	[mm]	$1,5 \cdot h_{ef}$		
Spacing		$s_{cr,N}$	[mm]	$3,0 \cdot h_{ef}$		
Splitting failure						
Edge distance $c_{cr,sp}$ [mm] for	$h / h_{ef} \geq 2,0$			$1,0 \cdot h_{ef}$		
	$2,0 > h / h_{ef} > 1,3$			$4,6 h_{ef} - 1,8 h$		
	$h / h_{ef} \leq 1,3$			$2,26 h_{ef}$		
Spacing		$s_{cr,sp}$	[mm]	$2 \cdot c_{cr,sp}$		

¹⁾ In absence of national regulations.

HVU2

Performance

Essential characteristics under tension loads in concrete

Annex C5

Table C3: Essential characteristics for HAS-U..., HAS-U...P and HAS-(E) under shear load in concrete

HAS-U..., HAS-U...P and HAS-(E)...		M8	M10	M12	M16	M20	M24	M27	M30
Steel failure without lever arm									
HAS-(E)...									
Characteristic resistance HAS-(E) 5.8	$V_{RK,s}^0$ [kN]	9,5	15,1	21,7	41,1	56,1	80,1	2)	2)
Partial factor	$\gamma_{Ms,V}^{1)}$ [-]	1,25						2)	2)
Characteristic resistance HAS-(E) 8.8	$V_{RK,s}^0$ [kN]	13,3	21,1	30,5	57,7	89,7	128,2	173,5	210,7
Partial factor	$\gamma_{Ms,V}^{1)}$ [-]	1,25							
Characteristic resistance HAS-(E)-R	$V_{RK,s}^0$ [kN]	11,6	18,5	26,7	50,5	78,5	112,2	108,4	131,7
Partial factor	$\gamma_{Ms,V}^{1)}$ [-]	1,40				1,56		2,38	
Characteristic resistance HAS-(E)-HCR	$V_{RK,s}^0$ [kN]	13,3	21,1	30,5	57,7	89,7	112,2	2)	2)
Partial factor	$\gamma_{Ms,V}^{1)}$ [-]	1,25					1,75	2)	2)
Ductility factor	k_7 [-]	1,0							
HAS-U... and HAS-U...P									
Characteristic resistance	$V_{RK,s}^0$ [kN]	$0,5 \cdot A_s \cdot f_{uk}$							
Partial factor HAS-U 5.8 (P)	$\gamma_{Ms,V}^{1)}$ [-]	1,25						2)	2)
Partial factor HAS-U 8.8 (P)	$\gamma_{Ms,V}^{1)}$ [-]	1,25							
Partial factor HAS-U A4 (P)	$\gamma_{Ms,V}^{1)}$ [-]	1,56						2,38	
Partial factor HAS-U HCR (P)	$\gamma_{Ms,V}^{1)}$ [-]	1,25					1,75	2)	2)
Ductility factor	k_7 [-]	1,0							

HVU2

Performance
Essential characteristics under shear loads in concrete

Annex C6

Table C3: continued

HAS-U..., HAS-U...P and HAS-(E)...		M8	M10	M12	M16	M20	M24	M27	M30
Steel failure with lever arm									
HAS-(E)...									
Characteristic resistance HAS-(E) 5.8	$M_{Rk,s}^0$ [Nm]	18	37	64	167	284	486	2)	2)
Partial factor	$\gamma_{Ms,V}^{1)}$ [-]	1,25						2)	2)
Characteristic resistance HAS-(E) 8.8	$M_{Rk,s}^0$ [Nm]	26	53	90	234	455	777	1223	1638
Partial factor	$\gamma_{Ms,V}^{1)}$ [-]	1,25							
Characteristic resistance HAS-(E)-R	$M_{Rk,s}^0$ [Nm]	23	45	79	205	398	680	765	1023
Partial factor	$\gamma_{Ms,V}^{1)}$ [-]	1,40				1,56		2,38	
Characteristic resistance HAS-(E)-HCR	$M_{Rk,s}^0$ [Nm]	26	52	90	234	455	680	2)	2)
Partial factor	$\gamma_{Ms,V}^{1)}$ [-]	1,25					1,75	2)	2)
Ductility factor	k_7 [-]	1,0							
HAS-U... and HAS-U...P									
Bending moment	$M_{Rk,s}^0$ [Nm]	$1,2 \cdot W_{el} \cdot f_{uk}$							
Ductility factor	k_7 [-]	1,0							
Concrete pry-out failure									
Pry-out factor	k_8 [-]	2,0							
Concrete edge failure									
Effective length of fastener	l_f [mm]	$\min (h_{ef}; 12 \cdot d_{nom})$						$\min (h_{ef}; 8 \cdot d_{nom}; 300)$	
Outside diameter of fastener	d_{nom} [mm]	8	10	12	16	20	24	27	30

¹⁾ In absence of national regulations.

²⁾ Fastener size not available

HVU2

Performance

Essential characteristics under shear loads in concrete

Annex C7

Table C4: Essential characteristics for internally threaded sleeve HIS-(R)N under shear loads in concrete

HIS-(R)N			M8	M10	M12	M16	M20
Steel failure without lever arm							
Characteristic resistance HIS-N with screw or threaded rod grade 8.8	$V_{Rk,s}^0$	[kN]	13	23	34	63	58
Partial factor	$\gamma_{Ms,V}^{1)}$	[-]	1,25				
Characteristic resistance HIS-RN with screw or threaded rod grade 70	$V_{Rk,s}^0$	[kN]	13	20	30	55	83
Partial factor	$\gamma_{Ms,V}^{1)}$	[-]	1,56				
Ductility factor	k_7	[-]	1,0				
Steel failure with lever arm							
Characteristic resistance HIS-N with screw or threaded rod grade 8.8	$M_{Rk,s}^0$	[Nm]	30	60	105	266	519
Partial factor	$\gamma_{Ms,V}^{1)}$	[-]	1,25				
Characteristic resistance HIS-RN with screw or threaded rod grade 70	$M_{Rk,s}^0$	[Nm]	26	52	92	233	454
Partial factor	$\gamma_{Ms,V}^{1)}$	[-]	1,56				
Ductility factor	k_7	[-]	1,0				
Concrete pry-out failure							
Pry-out factor	k_8	[-]	2,0				
Concrete edge failure							
Effective length of fastener	l_f	[mm]	90	110	125	170	205
Outside diameter of fastener	d_{nom}	[mm]	12,5	16,5	20,5	25,4	27,8

¹⁾ In absence of national regulations.

HVU2

Performance

Essential characteristics under shear loads in concrete

Annex C8

Table C5: Displacements for HAS-U..., HAS-U...P and HAS-(E) under tension load¹⁾

HAS-U..., HAS-U...P and HAS-(E)...			M8	M10	M12	M16	M20	M24	M27	M30
Uncracked concrete temperature range I to III										
Displacement	δ_{N0} -factor	[mm/(N/mm ²)]	0,06						0,15	
	$\delta_{N\infty}$ -factor	[mm/(N/mm ²)]	0,10						0,30	
Cracked concrete temperature range I to III										
Displacement	δ_{N0} -factor	[mm/(N/mm ²)]	0,10						0,15	
	$\delta_{N\infty}$ -factor	[mm/(N/mm ²)]	0,14						0,30	

¹⁾ Calculation of the displacement

$$\delta_{N0} = \delta_{N0\text{-factor}} \cdot \tau; \quad \delta_{N\infty} = \delta_{N\infty\text{-factor}} \cdot \tau \quad (\tau: \text{bond stress due to applied tension force}).$$

Table C6: Displacements for HAS-U..., HAS-U...P and HAS-(E) under shear load¹⁾

HAS-U..., HAS-U...P and HAS-(E)...			M8	M10	M12	M16	M20	M24	M27	M30
Displacement	δ_{V0} -factor	[mm/kN]	0,06	0,06	0,05	0,04	0,04	0,03		
	$\delta_{V\infty}$ -factor	[mm/kN]	0,09	0,08	0,08	0,06	0,06	0,05		

¹⁾ Calculation of the displacement

$$\delta_{V0} = \delta_{V0\text{-factor}} \cdot V; \quad \delta_{V\infty} = \delta_{V\infty\text{-factor}} \cdot V \quad (V: \text{applied shear force}).$$

Table C7: Displacements for internally threaded sleeves HIS-(R)N under tension load¹⁾

HIS-(R)N			M8	M10	M12	M16	M20	
Uncracked concrete temperature range I to III								
Displacement	δ_{N0} -factor	[mm/(N/mm ²)]	0,05				0,15	
	$\delta_{N\infty}$ -factor	[mm/(N/mm ²)]	0,10				0,15	
Cracked concrete temperature range I to III								
Displacement	δ_{N0} -factor	[mm/(N/mm ²)]	0,13				0,20	
	$\delta_{N\infty}$ -factor	[mm/(N/mm ²)]	0,15				0,20	

¹⁾ Calculation of the displacement

$$\delta_{N0} = \delta_{N0\text{-factor}} \cdot \tau; \quad \delta_{N\infty} = \delta_{N\infty\text{-factor}} \cdot \tau \quad (\tau: \text{bond stress due to applied tension force}).$$

Table C8: Displacements for internally threaded sleeves HIS-(R)N under shear load¹⁾

HIS-(R)N			M8	M10	M12	M16	M20
Displacement	δ_{V0} -factor	[mm/kN]	0,06	0,06	0,05	0,04	0,04
	$\delta_{V\infty}$ -factor	[mm/kN]	0,09	0,08	0,08	0,06	0,06

¹⁾ Calculation of the displacement

$$\delta_{V0} = \delta_{V0\text{-factor}} \cdot V; \quad \delta_{V\infty} = \delta_{V\infty\text{-factor}} \cdot V \quad (V: \text{applied shear force}).$$

HVU2

Performance
Displacements

Annex C9

Table C9: Essential characteristics for HAS-U..., HAS-U...P and HAS-(E) under tension loads for seismic performance category C1

HAS-U..., HAS-U...P and HAS-(E)...		M10	M12	M16	M20	M24	M27	M30
Steel failure								
HAS-U (HDG) 5.8 (P), HAS-(E)-(F) 5.8	$N_{Rk,s,c1}$ [kN]	29	42	79	123	177	1)	
HAS-U (HDG) 8.8 (P), HAS-(E)-(F) 8.8	$N_{Rk,s,c1}$ [kN]	46	67	126	196	282	367	449
HAS-U A4 (P), HAS-(E)-R	$N_{Rk,s,c1}$ [kN]	41	59	110	172	247	230	281
HAS-U HCR (P), HAS-(E)-HCR	$N_{Rk,s,c1}$ [kN]	46	67	126	196	247	1)	
Combined pullout and concrete cone failure in cracked concrete C20/25								
Hammer drilled holes								
Temperature range I: 24 °C / 40 °C	$\tau_{Rk,c1}$ [N/mm ²]	8,5	8,5	8,3	6,9	8,1	6,5	7,6
Temperature range II: 50 °C / 80 °C	$\tau_{Rk,c1}$ [N/mm ²]	6,5	6,5	6,4	5,3	6,2	5,0	5,8
Temperature range III: 72 °C / 120 °C	$\tau_{Rk,c1}$ [N/mm ²]	4,0	4,0	3,9	3,3	3,8	3,1	3,6
Hammer drilled holes with hollow drill bit TE-CD or TE-YD								
Temperature range I: 24 °C / 40 °C	$\tau_{Rk,c1}$ [N/mm ²]	2)	8,5	8,3	6,9	8,1	6,5	7,6
Temperature range II: 50 °C / 80 °C	$\tau_{Rk,c1}$ [N/mm ²]	2)	6,5	6,4	5,3	6,2	5,0	5,8
Temperature range III: 72 °C / 120 °C	$\tau_{Rk,c1}$ [N/mm ²]	2)	4,0	3,9	3,3	3,8	3,1	3,6
Diamond cored holes								
Temperature range I: 24 °C / 40 °C	$\tau_{Rk,c1}$ [N/mm ²]	7,0	7,0	7,0	7,0	7,0	7,0	7,0
Temperature range II: 50 °C / 80 °C	$\tau_{Rk,c1}$ [N/mm ²]	6,5	6,5	6,5	6,5	6,5	6,5	6,5
Temperature range III: 72 °C / 120 °C	$\tau_{Rk,c1}$ [N/mm ²]	4,0	4,0	4,0	4,0	4,0	4,0	4,0

1) Fastener size not available

2) Performance not assessed.

Table C10: Essential characteristics for HAS-U..., HAS-U...P and HAS-(E) under shear loads for seismic performance category C1

HAS-U..., HAS-U...P and HAS-(E)...		M10	M12	M16	M20	M24	M27	M30
Steel failure without lever arm								
HAS-U (HDG) 5.8 (P), HAS-(E)-(F) 5.8	$V_{Rk,s,c1}$ [kN]	11	15	27	43	62	1)	1)
HAS-U (HDG) 8.8 (P), HAS-(E)-(F) 8.8	$V_{Rk,s,c1}$ [kN]	16	24	44	69	99	129	157
HAS-U A4 (P), HAS-(E)-R	$V_{Rk,s,c1}$ [kN]	14	21	39	60	87	81	98
HAS-U HCR (P), HAS-(E)-HCR	$V_{Rk,s,c1}$ [kN]	16	24	44	69	87	1)	1)

1) Fastener size not available

HVU2

Performance

Essential characteristics for seismic performance category C1

Annex C10

Table C11: Essential characteristics for HAS-U..., HAS-U...P and HAS-(E) under tension loads for seismic performance category C2

HAS-U..., HAS-U...P and HAS-(E)...		M16	M20
Steel failure			
HAS-U (HDG) 8.8 (P), HAS-(E)-(F) 8.8	$N_{Rk,s,c2}$ [kN]	126	196
Combined pullout and concrete cone failure in cracked concrete C20/25 in hammer drilled holes and with hollow drill bit TE-CD or TE-YD			
Temperature range I: 24 °C / 40 °C	$\tau_{Rk,c2}$ [N/mm ²]	2,9	2,6
Temperature range II: 50 °C / 80 °C	$\tau_{Rk,c2}$ [N/mm ²]	2,3	2,1
Temperature range III: 72 °C / 120 °C	$\tau_{Rk,c2}$ [N/mm ²]	1,4	1,3

Table C12: Essential characteristics for HAS-U..., HAS-U...P and HAS-(E) under shear loads for seismic performance category C2

HAS-U..., HAS-U...P and HAS-(E)...		M16	M20
Steel failure without lever arm			
HAS-U 8.8 (P), HAS-(E) 8.8	$V_{Rk,s,c2}$ [kN]	40	71
HAS-U HDG 8.8 (P), HAS-(E)-F 8.8	$V_{Rk,s,c2}$ [kN]	30	46

Table C13: Displacements under tension load for seismic performance category C2

HAS-U..., HAS-U...P and HAS-(E)...		M16	M20
Displacement DLS	$\delta_{N,c2(DLS)}$ [mm]	0,2	0,2
Displacement ULS	$\delta_{N,c2(ULS)}$ [mm]	0,4	0,5

Table C14: Displacements under shear load for seismic performance category C2

HAS-U..., HAS-U...P and HAS-(E)...		M16	M20
Displacement DLS HAS-U 8.8 (P), HAS-(E) 8.8	$\delta_{V,c2(DLS)}$ [mm]	3,2	2,5
Displacement DLS HAS-U HDG 8.8 (P), HAS-(E)-F 8.8	$\delta_{V,c2(DLS)}$ [mm]	2,3	3,8
Displacement ULS HAS-U 8.8 (P), HAS-(E) 8.8	$\delta_{V,c2(ULS)}$ [mm]	9,2	7,1
Displacement ULS HAS-U HDG 8.8 (P), HAS-(E)-F 8.8	$\delta_{V,c2(ULS)}$ [mm]	4,3	9,1

HVU2

Performance

Essential characteristics for seismic performance category C2
Displacements

Annex C11