

Approval body for construction products  
and types of construction

Bautechnisches Prüfamt

An institution established by the Federal and  
Laender Governments



## European Technical Assessment

**ETA-18/1160**  
**of 29 April 2022**

English translation prepared by DIBt - Original version in German language

### General Part

Technical Assessment Body issuing the  
European Technical Assessment:

Deutsches Institut für Bautechnik

Trade name of the construction product

HUS4 Bonded screw

Product family  
to which the construction product belongs

Bonded screw fastener for use in concrete

Manufacturer

HILTI Corporation  
Feldkircherstraße 100  
9494 SCHAAN  
FÜRSTENTUM LIECHTENSTEIN

Manufacturing plant

Hilti Werke  
Hilti Plants

This European Technical Assessment  
contains

21 pages including 3 annexes which form an integral part  
of this assessment

This European Technical Assessment is  
issued in accordance with Regulation (EU)  
No 305/2011, on the basis of

EAD 332795-00-0601 Edition 12/2021

This version replaces

ETA-18/1160 issued on 5 January 2022

The European Technical Assessment is issued by the Technical Assessment Body in its official language. Translations of this European Technical Assessment in other languages shall fully correspond to the original issued document and shall be identified as such.

Communication of this European Technical Assessment, including transmission by electronic means, shall be in full. However, partial reproduction may only be made with the written consent of the issuing Technical Assessment Body. Any partial reproduction shall be identified as such.

This European Technical Assessment may be withdrawn by the issuing Technical Assessment Body, in particular pursuant to information by the Commission in accordance with Article 25(3) of Regulation (EU) No 305/2011.

**Specific Part**

**1 Technical description of the product**

The HUS4 Bonded screw consists of a foil capsule HUS4-MAX and a steel element HUS4 according to Annex A1. The anchor made of galvanized steel is screwed into a predrilled cylindrical drill hole, filled with a mortar capsule HUS4-MAX. The special thread of the anchor cuts an internal thread into the member while setting. The anchorage is characterized by mechanical interlock in the special thread.

Product and product description are given in Annex A.

**2 Specification of the intended use in accordance with the applicable European Assessment Document**

The performances given in Section 3 are only valid if the anchor is used in compliance with the specifications and conditions given in Annex B.

The verifications and assessment methods on which this European Technical Assessment is based lead to the assumption of a working life of the anchor of at least 50 years. The indications given on the working life cannot be interpreted as a guarantee given by the producer, but are to be regarded only as a means for choosing the right products in relation to the expected economically reasonable working life of the works.

**3 Performance of the product and references to the methods used for its assessment**

**3.1 Mechanical resistance and stability (BWR 1)**

Essential characteristic	Performance
Characteristic resistance to tension load (static and quasi-static loading)	See Annex B4, C1
Characteristic resistance to shear load (static and quasi-static loading)	See Annex C2
Characteristic resistance for simplified design	No performance assessed
Displacements (static and quasi-static loading)	See Annex C6
Characteristic resistance and displacements for seismic performance category C1	See Annex C3
Characteristic resistance and displacements for seismic performance category C2	See Annex C4, C6

**3.2 Safety in case of fire (BWR 2)**

Essential characteristic	Performance
Reaction to fire	Class A1
Resistance to fire	See Annex C5

**3.3 Aspects of durability linked with the basic works requirements**

See Annex B1.

English translation prepared by DIBt

**4 Assessment and verification of constancy of performance (AVCP) system applied, with reference to its legal base**

In accordance with European Assessment Document EAD No. 332795-00-0601 the applicable European legal act is: [96/582/EC].

The system to be applied is: 1

**5 Technical details necessary for the implementation of the AVCP system, as provided for in the applicable European Assessment Document**

Technical details necessary for the implementation of the AVCP system are laid down in the control plan deposited at Deutsches Institut für Bautechnik.

Issued in Berlin on 29 April 2022 by Deutsches Institut für Bautechnik

Dipl.-Ing. Beatrix Wittstock  
Head of Section

*beglaubigt:*  
Lange

### Installed condition without adjustment

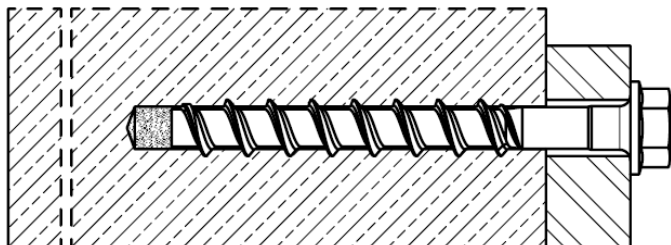

HUS4-H (hexagon head configuration sizes 10, 12 and 14)

HUS4-HF (hexagon head configuration sizes 10 and 14)

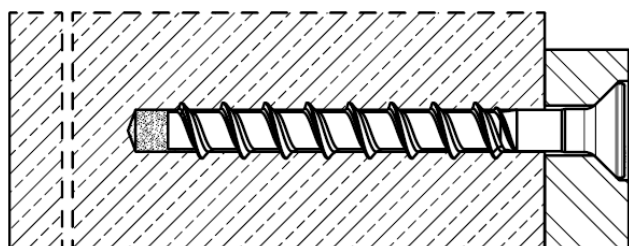

HUS4-C (countersunk head configuration size 10)

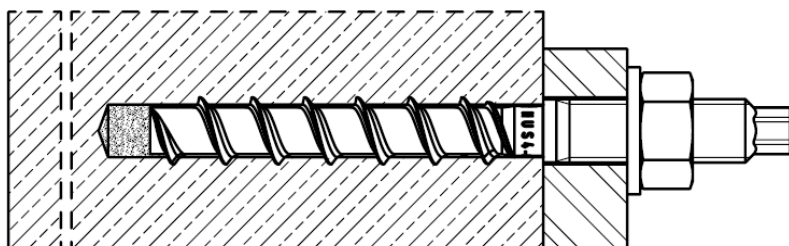

HUS4-A  
(threaded rod connection sizes 10 with M12 and 14 with M16)

HUS4-AF  
(threaded rod connection sizes 10 with M12 and 14 with M16)

### Installed condition with adjustment

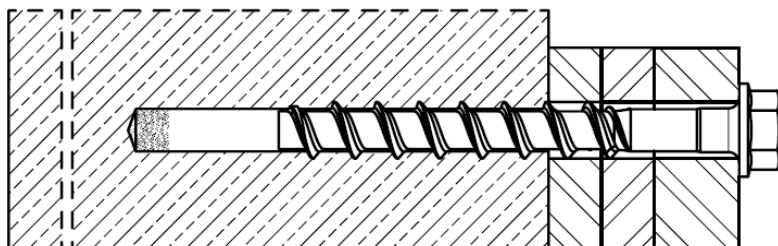

HUS4-H (hexagon head configuration sizes 10, 12, and 14)

HUS4-HF (hexagon head configuration sizes 10 and 14)

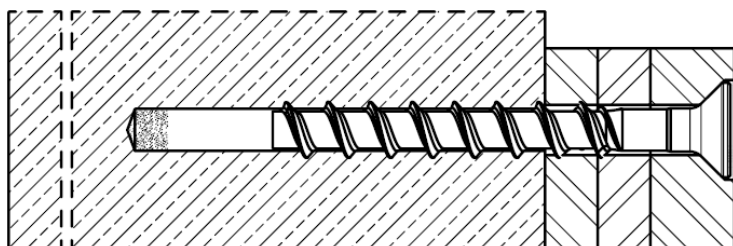

HUS4-C (countersunk head configuration size 10)

**HUS4 Bonded screw**

**Product description**  
Installed condition

**Annex A1**

### Product description: Foil capsule and steel elements

Foil capsule HUS4-MAX size 10 to 14: resin and hardener

Marking:  
HUS4-MAX size  
Expiry date mm/yyyy



**Table A1: Screw types**

<p><b>Hilti HUS4-H</b>, sizes 10, 12 and 14, hexagonal head configuration, galvanized  <b>Hilti HUS4-HF</b>, sizes 10 and 14, hexagonal head configuration, multilayer coating</p>
<p><b>Hilti HUS4-C</b>, size 10, countersunk head configuration, galvanized</p>
<p><b>Hilti HUS4-A</b>, size 10 with external thread M12 and size 14 with external thread M16, galvanized  <b>Hilti HUS4-AF</b>, size 10 with external thread M12 and size 14 with external thread M16, multilayer coating</p>

**Table A2: Hilti filling set (for HUS4-H and HUS4-A) and Hilti injection mortar**

Filling washer	Spherical washer	Injection mortar
		 Hilti HIT-HY ... with ETA Hilti HIT-RE ... with ETA

**HUS4 Bonded screw**



**Product description**  
Foil capsule / Steel elements

**Annex A2**

**Table A3: Materials**

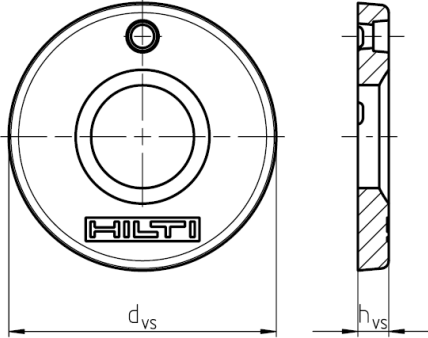

Part	Material
HUS4 screw anchor (all types see Table A1)	Carbon steel Rupture elongation $A_5 \leq 8\%$

**Table A4: Filling set dimensions**

Filling set size	M12	M16	
Diameter $d_{vs}$ [mm]	44	52	
Thickness $h_{vs}$ [mm]	5	6	
HUS4-H 	10	12 + 14	
HUS4-A 	10	14	

**Table A5: Fastener dimensions and marking HUS4-H(F)**

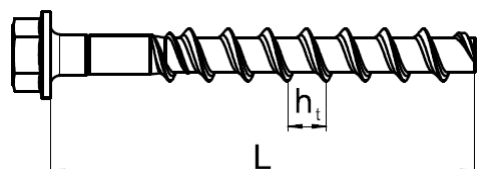
Fastener size HUS4-	H(F) 10	H 12	H(F) 14
Nominal fastener diameter $d$ [mm]	10	12	14
Nominal embedment depth $h_{nom}$ [mm]	85	100	115
Effective embedment depth $h_{ef}$ [mm]	85	100	115
Length of screw (min / max) $L$ [mm]	90 / 305	130 / 150	130 / 150

		<p><b>HUS4:</b> Hilti Universal Screw 4<sup>th</sup> generation</p> <p><b>H:</b> Hexagonal head, galvanized</p> <p><b>HF:</b> Hexagonal head, multilayer coating</p> <p><b>10:</b> Nominal screw diameter <math>d</math> [mm]</p> <p><b>100:</b> Length of screw <math>L</math> [mm]</p>
---	---	--



**HUS4 Bonded screw**

**Product description**  
Materials and fastener dimensions

**Annex A3**

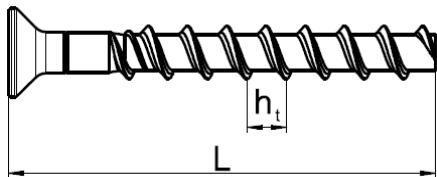
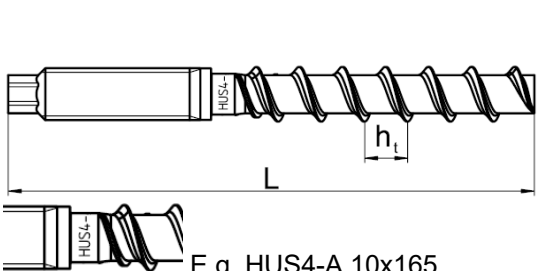

**Table A6: Fastener dimensions and marking HUS4-C**

Fastener size HUS4-			C 10
Nominal fastener diameter	d	[mm]	10
Nominal embedment depth	$h_{nom}$	[mm]	85
Effective embedment depth	$h_{ef}$	[mm]	85
Length of screw (min / max)	L	[mm]	100 / 120

		<p><b>HUS4:</b> Hilti Universal Screw 4<sup>th</sup> generation  <b>C:</b> Countersunk head, galvanized  <b>10:</b> Nominal screw diameter d [mm]  <b>100:</b> Length of screw L [mm]</p>
---	---	---

**Table A7: Fastener dimensions and marking HUS4-A (AF)**

Fastener size HUS4-A			A(F) 10	A(F) 14
Nominal fastener diameter	d	[mm]	10	14
Metric thread connection			M12	M16
Nominal embedment depth	$h_{nom}$	[mm]	85	115
Effective embedment depth	$h_{ef}$	[mm]	85	115
Length of screw (min / max)	L	[mm]	140 / 165	185 / 205

 <p>E.g. HUS4-A 10x165</p>		<p><b>HUS4:</b> Hilti Universal Screw 4<sup>th</sup> generation  <b>A:</b> Thread connection, galvanized  <b>AF:</b> Thread connection, multilayer coating  <b>10:</b> Nominal screw diameter d [mm]  <b>165:</b> Length of screw L [mm]  <b>8:</b> Carbon steel  <b>K:</b> Length identification HUS4-A 10x165</p>								
		<table border="1"> <thead> <tr> <th>I</th> <th>K</th> <th>L</th> <th>N</th> </tr> </thead> <tbody> <tr> <td>10x140</td> <td>10x165</td> <td>14x185</td> <td>14x205</td> </tr> </tbody> </table>	I	K	L	N	10x140	10x165	14x185	14x205
I	K	L	N							
10x140	10x165	14x185	14x205							

**HUS4 Bonded screw**

**Product description**  
Fastener dimensions

**Annex A4**



## Specifications of intended use

### Anchorage subject to:

- Static and quasi static loading
- Seismic performance category C1 and C2
- Fire exposure

### Base material:

- Compacted reinforced or unreinforced normal weight concrete without fibres according to EN 206:2013 +A1:2016.
- Strength classes C20/25 to C50/60 according to EN 206-1:2010+A1:2016.
- Cracked or uncracked concrete.

### Temperature in the base material:

- **at installation**  
-10 °C to +40 °C
- **in-service**  
Temperature range I: -40 °C to +120 °C  
(max. long term temperature +72 °C and max. short term temperature +120 °C)

### Use conditions (Environmental conditions):

- Anchorages subject to dry internal conditions.

### Design:

- Anchorages are designed under the responsibility of an engineer experienced in anchorages and concrete work.
- Verifiable calculation notes and drawings are prepared taking account of the loads to be anchored. The position of the fastener is indicated on the design drawings (e. g. position of the fastener relative to reinforcement or to supports, etc.).
- The anchorages are designed in accordance with EN 1992-4:2018 and EOTA Technical Report TR 075, Edition 10/2020.
- In case of requirements to resistance to fire local spalling of the concrete cover must be avoided.

### Installation:

- Concrete condition I1: installation in dry or wet (water saturated) concrete and use in service in dry concrete.
- Fastener installation carried out by appropriately qualified personnel and under the supervision of the person responsible for technical matters of the site.
- In case of aborted hole: new drilling at a minimum distance away of twice the depth of the aborted hole or smaller distance if the aborted hole is filled with high strength mortar and if under shear or oblique tension load it is not the direction of the load application.
- After installation further turning of the fastener must not be possible.
- The head of the fastener (HUS4-H and HUS4-C) must be supported on the fixture and is not damaged.
- Hilti filling set is suitable for HUS4-H and HUS4-A.



**HUS4 Bonded screw**

**Intended Use**  
Specifications

**Annex B1**



## Specifications of intended use: Drilling and cleaning

**Table B1: Static and quasi static loading**

HUS4		Fastener size
<b>Uncracked or cracked concrete</b>		
Hammer drilling (HD) <sup>1)</sup>	cleaned 	sizes 10 to 14
	not cleaned	
Hammer drilling with Hilti hollow drill bit TE-CD or TE-YD (HDB) <sup>1)</sup> 		sizes 12 and 14

<sup>1)</sup> Adjustment is possible for sizes 10 to 14

**Table B2: Seismic performance category C1**

HUS4		Fastener size
Hammer drilling (HD) <sup>1)</sup>	cleaned 	sizes 10 to 14
	not cleaned	
Hammer drilling with Hilti hollow drill bit TE-CD or TE-YD (HDB) <sup>1)</sup> 		sizes 12 and 14



<sup>1)</sup> Adjustment is possible for sizes 10 to 14

**Table B3: Seismic performance category C2**

HUS4		Fastener size
Hammer drilling (HD) <sup>1)</sup>	cleaned 	sizes 10 to 14
	not cleaned	

<sup>1)</sup> Adjustment is possible for sizes 10 to 14

**Table B4: Static and quasi static loading under fire exposure**

HUS4		Fastener size
Hammer drilling (HD) <sup>1)</sup>	cleaned 	sizes 10 to 14
	not cleaned	
Hammer drilling with Hilti hollow drill bit TE-CD or TE-YD (HDB) <sup>1)</sup> 		sizes 12 and 14

<sup>1)</sup> Adjustment is possible for sizes 10 to 14

**HUS4 Bonded screw**

**Intended Use  
Specifications**

**Annex B2**

### Installation parameters

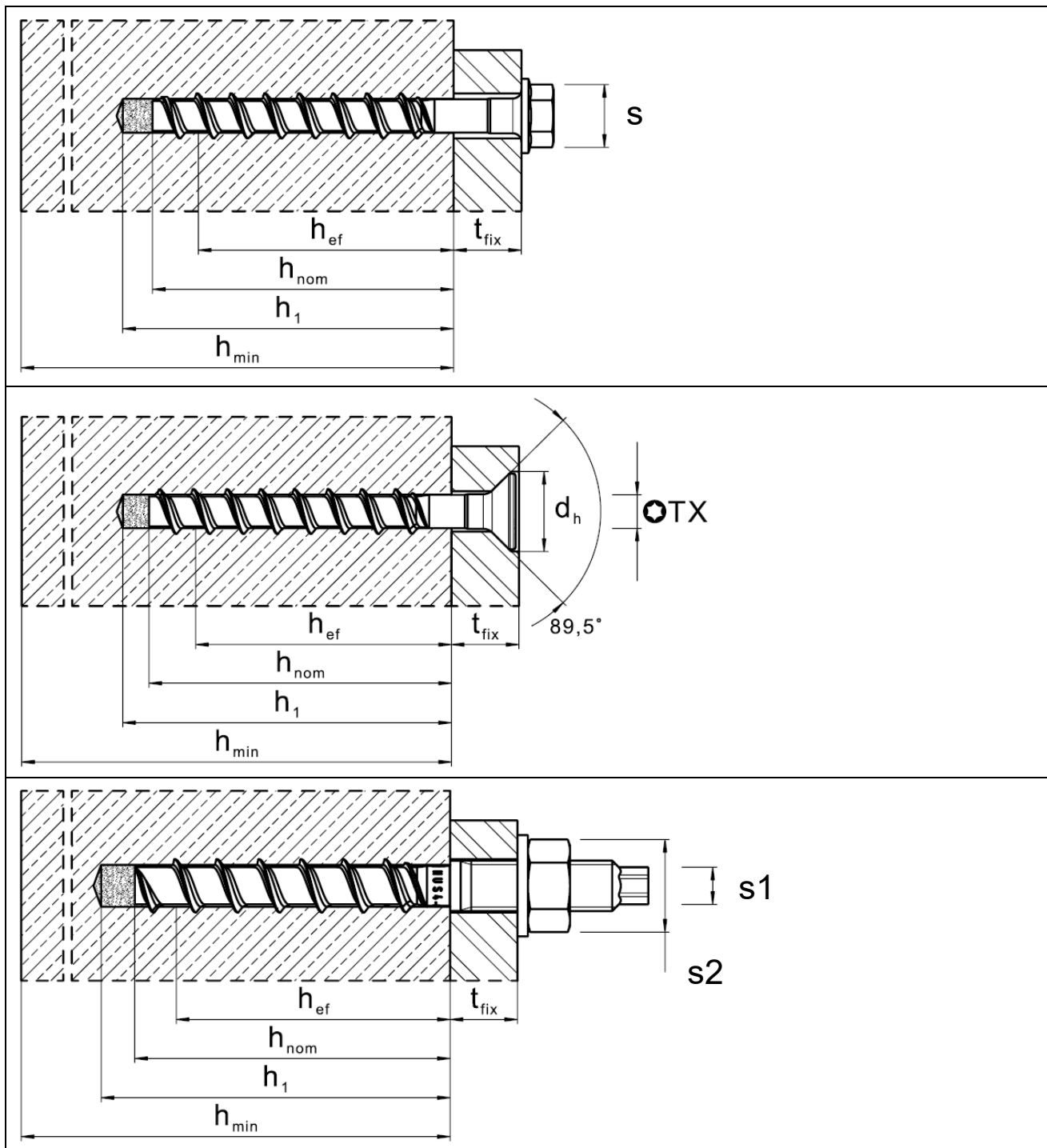

**HUS4 Bonded screw**

**Intended Use**  
Installation parameters

**Annex B3**

**Table B5: Installation parameters HUS4 Bonded screw**

Fastener size HUS4			10	12	14
Type			H, C, A	H	H, A
Nominal embedment depth	$h_{nom}$	[mm]	85	100	115
Nominal drill hole diameter	$d_0$	[mm]	10	12	14
Cutting diameter of drill bit	$d_{cut} \leq$	[mm]	10,45	12,50	14,50
Clearance hole diameter through setting	$d_f \begin{matrix} \min \\ \max \end{matrix}$	[mm]	13	15	17
			14	16	18
Clearance hole diameter pre setting (A-type)	$d_f \leq$	[mm]	14	-	18
Wrench size (H, HF-type)	s	[mm]	15	17	21
Wrench size for hex head (A-type)	s1	[mm]	8	-	12
Wrench size (A-type)	s2	[mm]	19	-	24
Maximum torque (A-type)	$\max T_{inst}$	[Nm]	40	-	80
Torx size (C-type)	TX	-	50	-	-
Diameter of countersunk head	$d_h$	[mm]	21	-	-
Depth of drill hole for cleaned hole or for uncleaned hole when drilling upwards	$h_1 =$	[mm]	$(h_{nom} + 10 \text{ mm})$		
			95	110	125
Depth of drill hole for uncleaned hole hammer drilling in wall and floor position	$h_1 =$	[mm]	$(h_{nom} + 10 \text{ mm}) + 2 * d_0$		
			115	134	153
Depth of drill hole (with adjustability) cleaned hole or for uncleaned hole when drilling upwards	$h_1 =$	[mm]	$(h_{nom} + 20 \text{ mm})$		
			105	120	135
Depth of drill hole (with adjustability) for uncleaned hole hammer drilling in wall and floor position	$h_1 =$	[mm]	$(h_{nom} + 20 \text{ mm}) + 2 * d_0$		
			125	144	163
Minimum thickness of concrete member	$h_{min} \geq$	[mm]	$(h_1 + 30 \text{ mm})$		
			140	160	200
Minimum spacing	$s_{min} \geq$	[mm]	40	50	60
Minimum edge distance	$c_{min} \geq$	[mm]	40	50	60
Hilti setting tool <sup>1)</sup>			SIW 22T-A SIW 6 AT-A22 SIW 6.2 AT-A22 SIW 8.1 AT gear 1 SIW 9-A22	SIW 22T-A SIW 6.2 AT-A22 SIW 8.1 AT SIW 9-A22	

<sup>1)</sup> Installation with other impact screw driver of equivalent power is possible.

**HUS4 Bonded screw**

**Intended Use**  
Installation parameters

**Annex B4**

## Installation

### Hole drilling and cleaning

#### Hammer drilling (HD) all sizes

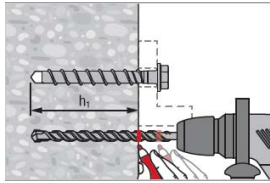

Mark drilling depth  $h_1$  for drilling with or without fixture in place.  
Details for drilling depth  $h_1$  see table B5.

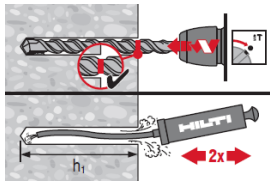

Cleaning needed in downward and horizontal installation direction with drill hole depth  
 $h_1 = h_{nom} + 10 \text{ mm}$

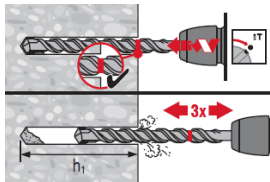

No cleaning is allowed in upward installation direction.  
No cleaning is allowed in downward and horizontal installation direction when 3x ventilation<sup>1)</sup> after drilling is executed.

Drill hole depth  $h_1 = h_{nom} + 10 \text{ mm} + 2 * d_0$   
<sup>1)</sup> moving the drill bit in and out of the drill hole 3 times after the recommended drilling depth  $h_1$  is achieved. This procedure shall be done with both revolution and hammer functions activated in the drilling machine. For more details read the relevant installation instruction (MP11).

#### Hammer drilling with Hilti hollow drill bit (HDB) TE-CD or TE-YD size 12 and 14.

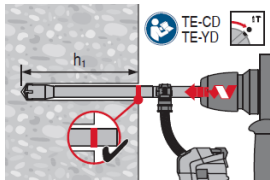

No cleaning needed  
 $h_1 = h_{nom} + 10 \text{ mm}$

#### Insert of HUS4-MAX foil capsule

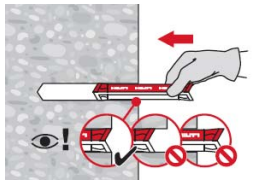

### HUS4 Bonded screw

Intended Use  
Installation instructions

Annex B5

**Fastener setting without adjustment**

Setting by impact screw driver

Setting parameters listed in Table B5

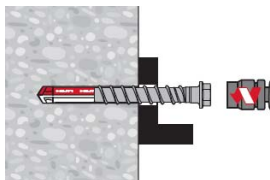

**Setting check**

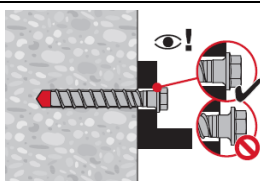

**Fastener setting with adjustment**

**Adjusting process 1**

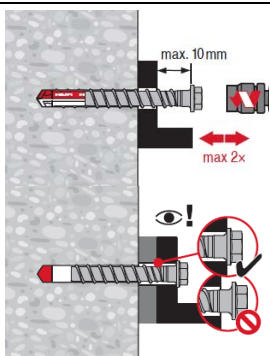

A screw can get adjusted maximum two times. The total allowed maximum thickness of shims added during the adjustment process is 10 mm. The final embedment depth after adjustment process must be larger or equal than  $h_{nom}$ .

**Adjusting process 2**

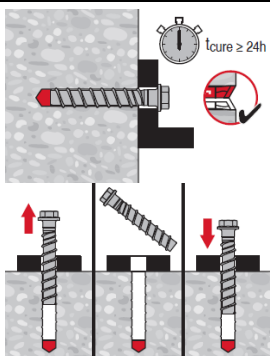

After minimum curing time of 24 h the HUS4 screw can screw out and in for 1 time.

**HUS4 Bonded screw**

**Intended Use**  
Installation instructions

**Annex B6**

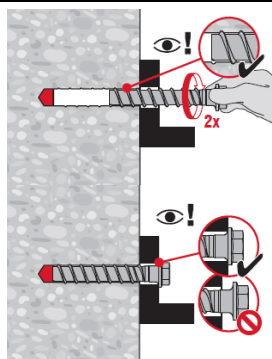

Find the thread in the drilled hole  
The screw should be screw in 2 revolutions by hand and finish with the setting tool.

### Overhead installation

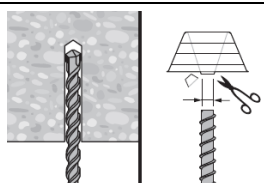

For upward installation direction use the overhead dripping cup HIT-OHC.

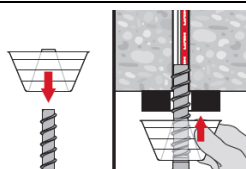

### Fastener setting with Hilti filling set

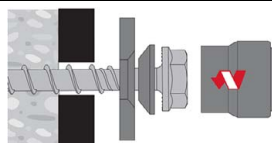

### Injection of Hilti HIT mortar and curing time

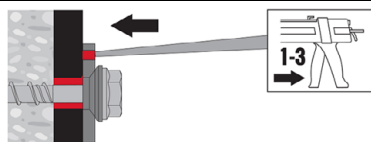

Fill the annular gap between screw and fixture with 1-3 strokes of a Hilti injection mortar HIT-HY ... or HIT-RE ... .  
Follow the installation instructions supplied with the respective Hilti injection mortar.  
After required curing time  $t_{\text{cure}}$  the fastening can be loaded.

**HUS4 Bonded screw**

**Intended Use**  
Installation instructions

**Annex B7**

**Table C1: Essential characteristics for HUS4 Bonded screw under tension load in case of static and quasi static loading**

HUS4-MAX with HUS4 screw			10 (H; A; C)	12 (H)	14 (H; A)
Nominal embedment depth	$h_{nom}$	[mm]	85	100	115
Installation factor	$\gamma_{inst}$	[-]	1,0		
<b>Adjustment</b>					
Total max. thickness of adjustment layers	$t_{adj}$	[mm]	10		
Max. number of adjustments	$n_a$	[-]	2		
<b>Steel failure</b>					
Characteristic resistance	$N_{Rk,s}$	[kN]	55,0	79,0	101,5
Partial factor	$\gamma_{Ms,N}^{1)}$	[-]	1,5		
<b>Combined pull-out and concrete failure</b>					
Uncracked concrete					
Temperature range I:	$N_{Rk,p,ucr}$	[kN]	38,0	55,0	70,0
Increasing factor for $N_{Rk,p,ucr} = N_{Rk,p,ucr(C20/25)} * \psi_c$	$\psi_c$	[-]	$(f_{ck}/20)^{0,30}$		
Cracked concrete					
Temperature range I:	$N_{Rk,p,cr}$	[kN]	24,0	36,0	42,0
Increasing factor for $N_{Rk,p,cr} = N_{Rk,p,cr(C20/25)} * \psi_c$	$\psi_c$	[-]	$(f_{ck}/20)^{0,50}$		
Sustained load factor	$\psi^{0}_{sus}$	[-]	0,94		
<b>Concrete cone failure</b>					
Effective embedment depth	$h_{ef}$	[mm]	85	100	115
Factor for uncracked concrete	$k_{ucr,N}$	[-]	11,0		
Factor for cracked concrete	$k_{cr,N}$	[-]	7,7		
Increasing factor for $N_{Rk,c} = N_{Rk,c(C20/25)} * \psi_c$	$\psi_c$	[-]	$(f_{ck}/20)^{0,50}$		
Edge distance	$c_{cr,N}$	[mm]	1,5 $h_{ef}$		
Spacing	$s_{cr,N}$	[mm]	3 $h_{ef}$		
<b>Splitting failure</b>					
Characteristic resistance	$N^0_{Rk,sp}$	[kN]	= $N_{Rk,p}$		
Edge distance	$c_{cr,sp}$	[mm]	1,6 $h_{ef}$	1,7 $h_{ef}$	1,85 $h_{ef}$
Spacing	$s_{cr,sp}$	[mm]	3,2 $h_{ef}$	3,4 $h_{ef}$	3,7 $h_{ef}$

<sup>1)</sup> In absence of other national regulations.

**HUS4 Bonded screw**

**Performances**

Essential characteristics under tension loads in case of static and quasi-static loading

**Annex C1**



**Table C2: Essential characteristics for HUS4 Bonded screw under shear load in case of static and quasi static loading**

HUS4-MAX with HUS4 screw			10 (H; A; C)	12 (H)	14 (H; A)
Nominal embedment depth	$h_{nom}$	[mm]	85	100	115
<b>Steel failure for shear load</b>					
Characteristic resistance	$V^{0}_{Rk,s}$	[kN]	32,0	44,9	62
Partial factor	$\gamma_{Ms,N}^{1)}$	[-]	1,25		
Ductility factor	$k_7$	[-]	0,8		
Characteristic resistance	$M^{0}_{Rk,s}$	[Nm]	64	125	186
<b>Concrete pry-out failure</b>					
Pry-out factor	$k_8$	[-]	2,0		
<b>Concrete edge failure</b>					
Effective length of fastener	$l_f$	[mm]	85	100	115
Diameter of fastener	$d$	[mm]	10	12	14

<sup>1)</sup> In absence of other national regulations.

**HUS4 Bonded screw**

**Performances**

Essential characteristics under shear load in case of static and quasi static loading

**Annex C2**

**Table C3: Essential characteristics for HUS4 Bonded screw seismic performance category C1 in concrete**

<b>HUS4-MAX with HUS4 screw</b>		<b>10 (H; A; C)</b>	<b>12 (H)</b>	<b>14 (H; A)</b>
Nominal embedment depth	$h_{nom}$ [mm]	85	100	115
<b>Adjustment</b>				
Total max. thickness of adjustment layers	$t_{adj}$ [mm]	10		
Max. number of adjustments	$n_a$ [-]	2		
<b>Steel failure for tension and shear load</b>				
Characteristic resistance	$N_{Rk,s,C1}$ [kN]	55,0	79,0	101,5
Partial factor	$\gamma_{Ms,N}^{1)}$ [-]	1,5		
Characteristic resistance	$V_{Rk,s,C1}$ [kN]	26,7	38,9	34,5
Partial factor	$\gamma_{Ms,V}^{1)}$ [-]	1,25		
Reduction factor acc. to EN 1992-4:2018 annular gap unfilled	$\alpha_{gap}$ [-]	0,5		
Reduction factor acc. to EN 1992-4:2018 annular gap filled	$\alpha_{gap}$ [-]	1,0		
<b>Combined pullout and concrete cone failure Cracked concrete C20/25</b>				
Temperature range I	$N_{Rk,p,C1}$ [kN]	24,0	36,0	42,0
<b>Concrete cone failure</b>				
Effective embedment depth	$h_{ef}$ [mm]	85	100	115
Edge distance	$c_{cr,N}$ [mm]	1,5 $h_{ef}$		
Spacing	$s_{cr,N}$ [mm]	3 $h_{ef}$		
Installation factor	$\gamma_{inst}$ [-]	1,0		
<b>Concrete pry-out failure</b>				
Pry-out factor	$k_8$ [-]	2,0		
<b>Concrete edge failure</b>				
Effective length of fastener	$l_f = h_{ef}$ [mm]	85	100	115
Outside diameter of fastener	$d_{nom}$ [mm]	10	12	14

<sup>1)</sup> In absence of other national regulations.

**HUS4 Bonded screw**

**Performances**

Essential characteristics for seismic performance category C1 in concrete

**Annex C3**

**Table C4: Essential characteristics for HUS4 Bonded screw seismic performance category C2 in concrete**

HUS4-MAX with HUS4 screw		10 (H; A; C)	12 (H)	14 (H; A)
Nominal embedment depth	$h_{nom}$ [mm]	85	100	115
<b>Adjustment</b>				
Total max. thickness of adjustment layers	$t_{adj}$ [mm]	10		
Max. number of adjustments	$n_a$ [-]	2		
<b>Steel failure for tension</b>				
Characteristic resistance	$N_{Rk,s,C2}$ [kN]	55,0	79,0	101,5
Partial factor	$\gamma_{Ms,N}^{1)}$ [-]	1,5		
<b>Steel failure shear load</b>				
Partial factor	$\gamma_{Ms,V}^{1)}$ [-]	1,25		
Installation with Hilti filling set (HUS4-H and HUS4-A)				
Characteristic resistance	$V_{Rk,s,C2}$ [kN]	21,5	27,2	46,5
Reduction factor acc. to EN 1992-4:2018 annular gap filled	$\alpha_{gap}$ [-]	1,0		
Installation without Hilti filling set				
Characteristic resistance	$V_{Rk,s,C2}$ [kN]	13,7	22,5	34,4
Reduction factor acc. to EN 1992-4:2018 annular gap unfilled	$\alpha_{gap}$ [-]	0,5		
<b>Combined pullout and concrete cone failure Cracked concrete C20/25</b>				
Temperature range I	$N_{Rk,p,C2}$ [kN]	10,7	17,2	18,2
<b>Concrete cone failure</b>				
Effective embedment depth	$h_{ef}$ [mm]	85	100	115
Edge distance	$c_{cr,N}$ [mm]	1,5 $h_{ef}$		
Spacing	$s_{cr,N}$ [mm]	3 $h_{ef}$		
Installation factor	$\gamma_{inst}$ [-]	1,0		
<b>Concrete pry-out failure</b>				
Pry-out factor	$k_8$ [-]	2,0		
<b>Concrete edge failure</b>				
Effective length of fastener	$l_f = h_{ef}$ [mm]	85	100	115
Outside diameter of fastener	$d_{nom}$ [mm]	10	12	14

<sup>1)</sup> In absence of other national regulations.

**HUS4 Bonded screw**

**Performances**

Essential characteristics for seismic performance category C2 in concrete

**Annex C4**

**Table C5: Essential characteristics under fire exposure in concrete for HUS4-Bonded screw**

HUS4-MAX with HUS4 screw				10		12	14		
				H(F)	C 10	A(F)	H	H(F)	A(F)
Nominal embedment depth	$h_{nom}$	[mm]	85	85	85	100	115	115	
<b>Steel failure for tension and shear load (<math>F_{Rk,s,fi} = N_{Rk,s,fi} = V_{Rk,s,fi}</math>)</b>									
Characteristic resistance	R30	$F_{Rk,s,fi}$	[kN]	4,2	1,0	4,2	7,7	10,5	8,4
	R60	$F_{Rk,s,fi}$	[kN]	3,2	0,9	3,3	5,9	8,1	6,8
	R90	$F_{Rk,s,fi}$	[kN]	2,4	0,7	2,5	4,1	5,8	5,1
	R120	$F_{Rk,s,fi}$	[kN]	1,7	0,6	2,1	3,1	4,4	4,3
	R30	$M^0_{Rk,s,fi}$	[Nm]	4,9	1,2	4,8	11,6	19,3	15,4
	R60	$M^0_{Rk,s,fi}$	[Nm]	3,7	1,0	3,8	8,9	14,8	12,4
	R90	$M^0_{Rk,s,fi}$	[Nm]	2,7	0,8	2,9	6,2	10,7	9,3
	R120	$M^0_{Rk,s,fi}$	[Nm]	1,9	0,6	2,4	4,7	8,1	7,8
<b>Pull-out failure</b>									
Characteristic resistance	R30	$N_{Rk,p,fi}$	[kN]	4,7		6,1	7,5		
	R60								
	R90								
	R120								$N_{Rk,p,fi}$
<b>Edge distance</b>									
R30 to R120			$c_{cr,fi}$	[mm]	2 $h_{ef}$				
In case of fire attack from more than one side, the minimum edge distance shall be $\geq 300$ mm									
<b>Fastener spacing</b>									
R30 to R120			$s_{cr,fi}$	[mm]	2 $c_{cr,fi}$				
<b>Concrete pry-out failure</b>									
R30 to R120			$k_8$	[-]	2,0				
The anchorage depth shall be increased for wet concrete by at least 30 mm.									

**HUS4 Bonded screw**

**Performances**  
Essential characteristics under fire exposure in concrete

**Annex C5**

**Table C6: Displacements under tension load for HUS4 Bonded screw in case of static and quasi static loading**

HUS4 MAX with HUS4 screw		10 (H; A; C)		12 (H)		14 (H; A)		
		Uncracked concrete	Cracked concrete	Uncracked concrete	Cracked concrete	Uncracked concrete	Cracked concrete	
<b>Temperature range I</b>								
Displacement	N	[kN]	17,1	10,5	23,8	16,2	31,0	18,1
	$\delta_{N0}$	[mm]	0,3	0,3	0,4	0,5	0,5	0,6
	$\delta_{N\infty}$	[mm]	0,6	0,6	0,6	0,6	0,8	0,8

**Table C7: Displacements under shear load for HUS4 Bonded screw in case of static and quasi static loading**

HUS4 MAX with HUS4 screw		10 (H; A; C)		12 (H)		14 (H; A)	
		<b>Temperature range I</b>					
Displacement	V	[kN]	18,3	25,7	35,4		
	$\delta_{V0}$	[mm]	1,0	0,9	4,0		
	$\delta_{V\infty}$	[mm]	1,5	1,4	6,0		

**Table C8: Displacements under tension and shear load for HUS4 Bonded screw for seismic category C2**

HUS4 MAX with HUS4 screw		10 (H; A)		12 (H)		14 (H; A)	
		<b>Temperature range I</b>					
Tension load							
Displacement DLS	$\delta_{N,C2}$ (DLS)	[mm]	0,75	0,70	0,77		
Displacement ULS	$\delta_{N,C2}$ (ULS)	[mm]	2,07	3,43	4,24		
Shear load with Hilti filling set (HUS4-H and HUS4-A)							
Displacement DLS	$\delta_{V,C2}$ (DLS)	[mm]	1,72	1,73	2,52		
Displacement ULS	$\delta_{V,C2}$ (ULS)	[mm]	6,88	5,62	6,79		
Shear load without Hilti filling set (HUS4-H and HUS4-A)							
Displacement DLS	$\delta_{V,C2}$ (DLS)	[mm]	5,02	4,90	4,93		
Displacement ULS	$\delta_{V,C2}$ (ULS)	[mm]	8,97	7,00	9,14		

**HUS4 Bonded screw**

**Performances**  
Displacements

**Annex C6**