

Approval body for construction products
and types of construction

Bautechnisches Prüfamt

An institution established by the Federal and
Laender Governments



European Technical Assessment

ETA-22/0551
of 24 October 2022

English translation prepared by DIBt - Original version in German language

General Part

Technical Assessment Body issuing the
European Technical Assessment:

Deutsches Institut für Bautechnik

Trade name of the construction product

Concrete Screw BSZ2

Product family
to which the construction product belongs

Mechanical fasteners for use in concrete

Manufacturer

MKT
Metall-Kunststoff-Technik GmbH & Co. KG
Auf dem Immel 2
67685 Weilerbach
DEUTSCHLAND

Manufacturing plant

MKT Werk 5, D

This European Technical Assessment
contains

17 pages including 3 annexes which form an integral part
of this assessment

This European Technical Assessment is
issued in accordance with Regulation (EU)
No 305/2011, on the basis of

EAD 330232-01-0601, Edition 05/2021

The European Technical Assessment is issued by the Technical Assessment Body in its official language. Translations of this European Technical Assessment in other languages shall fully correspond to the original issued document and shall be identified as such.

Communication of this European Technical Assessment, including transmission by electronic means, shall be in full. However, partial reproduction may only be made with the written consent of the issuing Technical Assessment Body. Any partial reproduction shall be identified as such.

This European Technical Assessment may be withdrawn by the issuing Technical Assessment Body, in particular pursuant to information by the Commission in accordance with Article 25(3) of Regulation (EU) No 305/2011.

Specific Part

1 Technical description of the product

The concrete screw BSZ2 is an anchor in size 6, 8 and 10 mm made of stainless steel. The anchor is screwed into a predrilled cylindrical drill hole. The special thread of the anchor cuts an internal thread into the member while setting. The anchorage is characterised by mechanical interlock in the special thread.

Product and product description are given in Annex A.

2 Specification of the intended use in accordance with the applicable European Assessment Document

The performances given in Section 3 are only valid if the concrete screw is used in compliance with the specifications and conditions given in Annex B.

The verifications and assessment methods on which this European Technical Assessment is based lead to the assumption of a working life of the concrete screw of at least 50 years. The indications given on the working life cannot be interpreted as a guarantee given by the producer, but are to be regarded only as a means for choosing the right products in relation to the expected economically reasonable working life of the works.

3 Performance of the product and references to the methods used for its assessment

3.1 Mechanical resistance and stability (BWR 1)

Essential characteristic	Performance
Characteristic resistance to tension load (static and quasi-static loading)	See Annex B2 and C1
Characteristic resistance to shear load (static and quasi-static loading)	See Annex C2
Displacements (static and quasi-static loading)	See Annex C5
Characteristic resistance and displacements for seismic performance categorie C1	See Annex C3

3.2 Safety in case of fire (BWR 2)

Essential characteristic	Performance
Reaction to fire	Class A1
Resistance to fire	See Annex C4

3.3 Aspects of durability linked with the Basic Works Requirements

Essential characteristic	Performance
Durability	See Annex B1

4 Assessment and verification of constancy of performance (AVCP) system applied, with reference to its legal base

In accordance with European Assessment Document EAD No. 330232-01-0601 the applicable European legal act is: [96/582/EC].

The system to be applied is: 1

5 Technical details necessary for the implementation of the AVCP system, as provided for in the applicable European Assessment Document

Technical details necessary for the implementation of the AVCP system are laid down in the control plan deposited at Deutsches Institut für Bautechnik.

Issued in Berlin on 24 October 2022 by Deutsches Institut für Bautechnik

Dipl.-Ing. Beatrix Wittstock
Head of Section

beglaubigt:
Baderschneider

Concrete Screw BSZ2

- stainless steel A4
- high corrosion resistant steel HCR

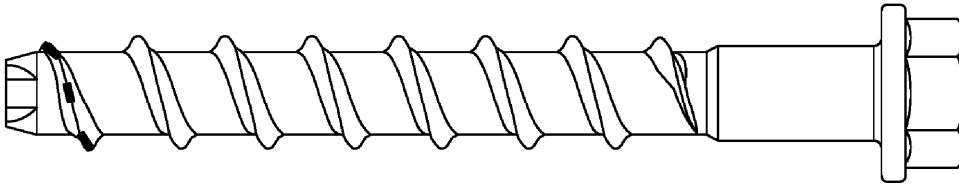

e.g. Concrete Screw BSZ2 with hexagon head and pressed-on washer

Installation condition

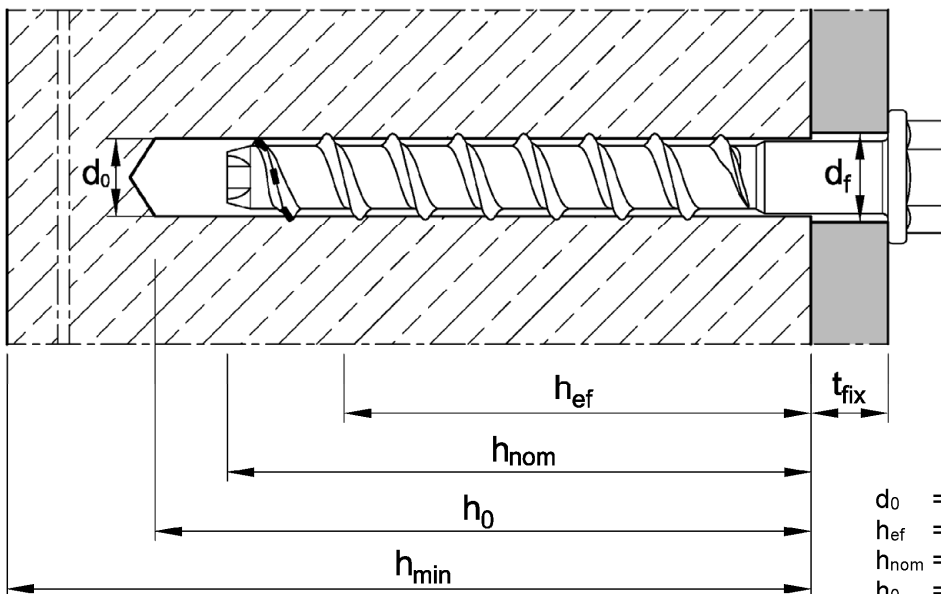

- d_0 = nominal drill bit diameter
- h_{ef} = effective anchorage depth
- h_{nom} = nominal embedment depth
- h_0 = depth of the drill hole
- h_{min} = minimum thickness of member
- t_{fix} = thickness of fixture
- d_f = diameter of clearance hole in the fixture

Filling washer and reducing adapter (optional)
for filling the annular gap between concrete screw and fixture

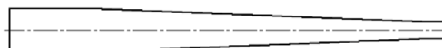
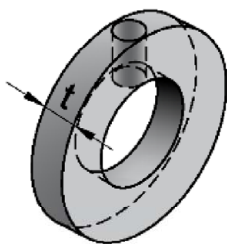









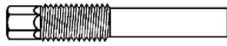

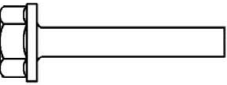

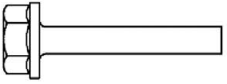
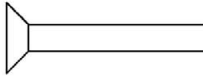

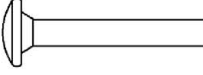
Concrete Screw BSZ2

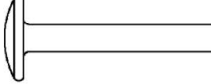
Product description
Product and installation condition

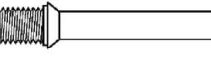
Annex A1

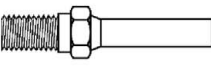
Table A1: Anchor types

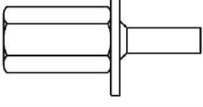
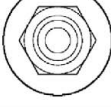
Type		Description
B		Anchor version with metric connection thread and hexagon drive e.g.: BSZ2-B 10x140 A4
		
S		Anchor version with hexagon head, pressed-on washer and TORX drive e.g.: BSZ2-SU 10x140 A4 TX
		
		
SK		Anchor version with countersunk head and TORX drive e.g.: BSZ2-SK 10x140 A4
		
LK		Anchor version with pan head and TORX drive e.g.: BSZ2-LK 10x140 A4
		
BS		Anchor version with large pan head and TORX drive e.g.: BSZ2-GLK 10x140 A4
		
M		Anchor version with countersunk head and metric connection thread e.g.: BSZ2-BSK 10x140 A4
		
M		Anchor version with hexagon drive and metric connection thread e.g.: BSZ2-BS 10x140 A4
		
M		Anchor version with internal thread and hexagon drive e.g.: BSZ2-M 10x140 A4
		

Electronic copy of the ETA by DIBt: ETA-22/0551

Concrete Screw BSZ2

Product description
Anchor types

Annex A2

Table A2: Dimensions

Screw size			BSZ2 6			BSZ2 8			BSZ2 10		
Nominal embedment depth	h_{nom}	[mm]	35 ¹⁾	45	55	45	55	65	55	75	85
Length of the anchor	$L \leq$	[mm]	500								
Core diameter	d_k	[mm]	5,1			7,2			9,2		
Outside diameter	d_s	[mm]	7,6			10,5			12,5		
Thickness of filling washer	t	[mm]	5			5			5		

¹⁾ Only for statically indeterminate non-structural systems (multiple use) according to EN 1992-4:2018, in dry internal conditions.

Marking e.g.: \diamond BSZ 10 100
or TSM 10 100

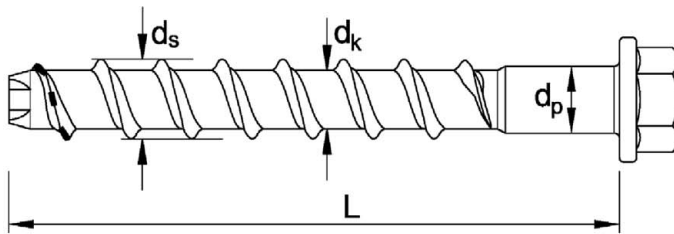

\diamond BSZ Trade name
or (optional with manufacturer identification \diamond)
TSM
10 Anchor size
100 Length of anchor

additional marking:

A4 stainless steel, or
HCR high corrosion resistant steel

Table A3: Materials

Version	Stainless steel BSZ2 A4	High corrosion resistant steel BSZ2 HCR
Material numbers	1.4401, 1.4404, 1.4571, 1.4578	1.4529
Characteristic yield strength	f_{yk}	560 N/mm ²
Characteristic ultimate strength	f_{uk}	700 N/mm ²
Fracture elongation	A5	$\leq 8\%$

Concrete Screw BSZ2

Product description
Dimensions, marking and materials

Annex A3

Specifications of Intended use

Concrete screw BSZ		BSZ2 6			BSZ2 8			BSZ2 10				
Nominal embedment depth h_{nom}		$h_{nom1}^{1)}$	h_{nom2}	h_{nom3}	h_{nom1}	h_{nom2}	h_{nom3}	h_{nom1}	h_{nom2}	h_{nom3}		
[mm]		35	45	55	45	55	65	55	75	85		
Anchorage subject to	Static or quasi-static action	✓										
	Fire exposure	✓										
	Seismic action, performance category C1	Tension load:		all anchor types								
		Shear load:		anchor types B, S, SK, LK								
		2)	✓	✓	✓	2)	✓	✓	2)	✓		
Base material	Cracked or uncracked concrete	✓										
	Compacted, reinforced or unreinforced concrete without fibres acc. to EN 206:2013+A1:2016	✓										
	Strength classes according to EN 206:2013+A1:2016, C20/25 to C50/60	✓										

1) Only for statically indeterminate non-structural systems (multiple use) according to EN 1992-4:2018, in dry internal conditions.

2) no performance assessed

Use conditions (Environmental conditions):

- Structures subject to dry internal conditions: all screw types
- For all other conditions corresponding to corrosion resistance classes CRC according to EN 1993-1-4:2006 +A1:2015:
 - stainless steel A4, according to Annex A3, Table A3: CRC III
 - high corrosion resistant steel HCR, according to Annex A3, Table A3: CRC V

Design:

- Anchorage are designed under the responsibility of an engineer experienced in anchorages and concrete work.
- Verifiable calculation notes and drawings are prepared taking account of the loads to be anchored. The position of the anchor is indicated on the design drawings (e.g. position of the anchor relative to reinforcement or to supports, etc.)
- Design method of anchorages according to EN 1992-4:2018 (if required in connection with EOTA Technical Report TR 055, version February 2018)

Installation:

- Making of drill hole by hammer drilling (all sizes) or vacuum drilling (BSZ 8 und BSZ 10). When using a vacuum drill bit no drill hole cleaning is required.
- Anchor installation carried out by appropriately qualified personal and under the responsibility of the person responsible for technical matters on site.
- After installation further turning of the anchor is not possible. The head of the anchor is supported on the fixture and is not damaged.
- The borehole may be filled with the Injection System VME plus.
- Adjustment according to Annex B4 (except for anchorages with filled borehole and anchorages with seismic action).

Concrete Screw BSZ2

Intended Use
Specifications

Annex B1

Table B1: Installation parameters

Screw size		BSZ2 6			BSZ2 8			BSZ2 10		
Nominal embedment depth	h_{nom} [mm]	35 ¹⁾	45	55	45	55	65	55	75	85
Nominal drill bit diameter	d_0 [mm]	6			8			10		
Cutting diameter of drill bit	$d_{cut} \leq$ [mm]	6,40			8,45			10,45		
Depth of drill hole	$h_0 \geq$ [mm]	40	50	60	55	65	75	65	85	95
Diameter of clearance hole in the fixture	$d_f \leq$ [mm]	8			12			14		
Max. installation torque for screws with metric connection thread	$T_{inst} \leq$ [Nm]	10			20			40		
Tangential impact screw driver ²⁾	$T_{imp,max}$ [Nm]	160			300			450		

¹⁾ Only for statically indeterminate non-structural systems (multiple use) according to EN 1992-4:2018, in dry internal conditions.

²⁾ Installation with tangential impact screw driver, with maximum torque $T_{imp,max}$ acc. to manufacturer's instructions is possible.

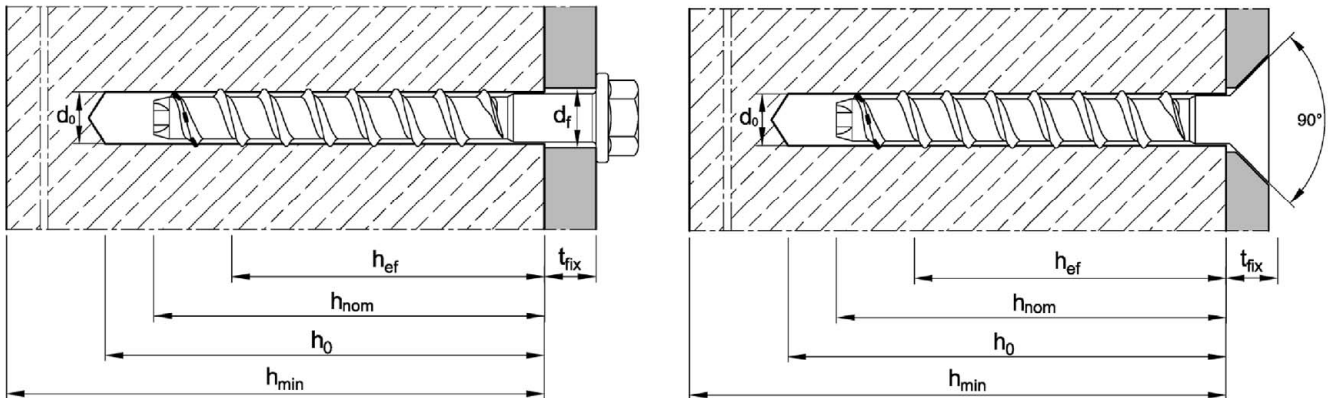

Table B2: Minimum thickness of member, minimum edge distance and minimum spacing

Screw size		BSZ2 6			BSZ2 8			BSZ2 10		
Nominal embedment depth	h_{nom} [mm]	35 ¹⁾	45	55	45	55	65	55	75	85
Minimum thickness of member	h_{min} [mm]	80	80	100	80	100	120	100	130	130
Minimum spacing	s_{min} [mm]	35			35			40		
Minimum edge distance	c_{min} [mm]	35			35			40		

¹⁾ Only for statically indeterminate non-structural systems (multiple use) according to EN 1992-4:2018, in dry internal conditions.

Concrete Screw BSZ2

Intended Use

Installation parameters / Minimum thickness of concrete member, minimum spacing and edge distance

Annex B2

Installation instructions

Drill hole preparation and cleaning		
1		<p>Drill hole perpendicular to concrete surface. Using a vacuum drill, continue with step 3.</p>
2		<p>Blow out dust or alternatively vacuum clean down to the bottom of the hole.</p>
Installation concrete screw		
3		<p>Screw in, e.g. with tangential impact screw driver or torque wrench.</p>
4		<p>After installation, the head of the anchor is supported on the fixture and must be undamaged.</p>
<p>For screw size BSZ2 6 with $h_{nom} = 35$ mm, installation only with impact screw drivers.</p>		

Concrete Screw BSZ2

Intended Use
Installation instructions

Annex B3

Installation instructions - Adjustment

1. Adjustment

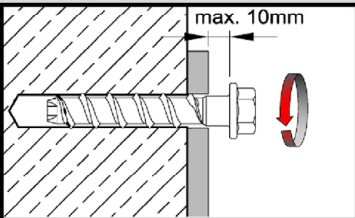
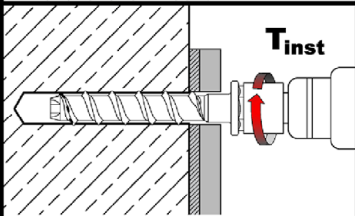
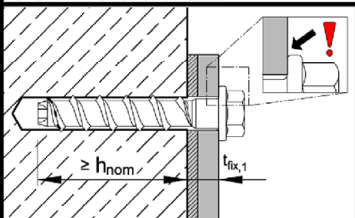
5		Screw may be untightened maximum 10 mm.
6		After adjustment, screw in the concrete screw with tangential impact screw driver or torque wrench.
7		After installation, the head of the anchor is supported on the fixture must be undamaged.

2. Adjustment

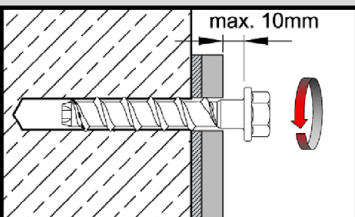
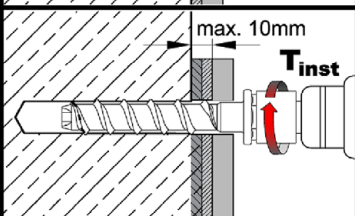
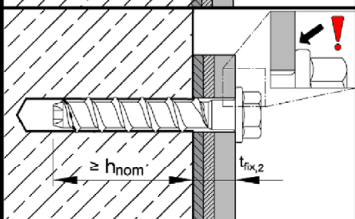
8		Screw may be untightened maximum 10 mm.
9		After adjustment, screw in the concrete screw with tangential impact screw driver or torque wrench.
10		After installation, the head of the anchor is supported on the fixture and must be undamaged.

Note:

The concrete screw may be adjusted max. 2 times. The fastener must not be screwed back by more than 10 mm in each case. The relining carried out during adjustment must not exceed 10 mm in total. Nominal embedment depth h_{nom} must still be maintained after the adjustment.

Concrete Screw BSZ2

Intended Use
Installation instructions - Adjustment

Annex B4

Installation instructions - filling of annular gap

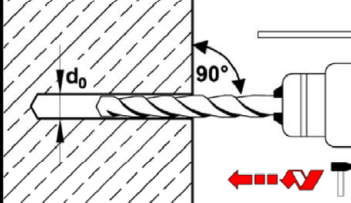
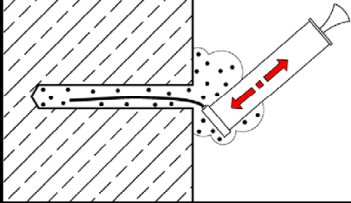
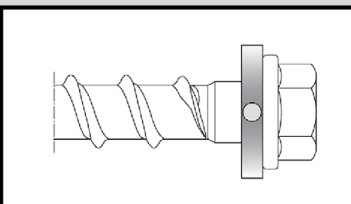
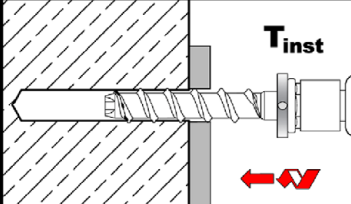
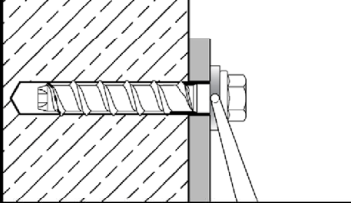
Drill hole preparation and cleaning		
1		Drill hole perpendicular to concrete surface. Using a vacuum drill, continue with step 3.
2		Blow out dust or alternatively vacuum clean down to the bottom of the hole.
Installation concrete screw with filling washer		
3		Fit the filling washer to the concrete screw or position at the attachment. The thickness of the filling washer must be taken into account with t_{fix} .
4		Screw in, e.g. with tangential impact screw driver or torque wrench.
5		Fill the annular gap between concrete screw and fixture with mortar (compressive strength $\geq 40 \text{ N/mm}^2$, e.g. Injection mortar VMH, VMZ or VMU plus). Use enclosed reducing adapter. Observe information on processing of the mortar! The annular gap is completely filled, when excess mortar seeps out.
For seismic loading, the application <u>with</u> and <u>without</u> filling of annular gap is permitted (Annex C3).		

Concrete Screw BSZ2

Intended Use
Installation instructions - filling of annular gap

Annex B5

Table C1: Characteristic values for tension load under static or quasi-static action

Screw size			BSZ2 6			BSZ2 8			BSZ2 10			
Nominal embedment depth	h_{nom}	[mm]	35 ¹⁾	45	55	45	55	65	55	75	85	
Installation factor	γ_{inst}	[-]	1,0									
Steel failure												
Characteristic resistance	$N_{Rk,s}$	[kN]	14,0			27,0			45,0			
Partial factor ²⁾	$\gamma_{Ms,N}$	[-]	1,5									
Pull-out failure (concrete strength class C20/25)												
Characteristic resistance	cracked	$N_{Rk,p,cr}$	[kN]	2,5	1,5	3,0	3,0	5,5	8,0	6,0	13,0	17,0
	uncracked	$N_{Rk,p,ucr}$	[kN]	3,5	4,0	8,5	9,0	12,0	17,0	11,0	19,0	25,0
Exponent m for concrete increasing factor $\Psi_c = \left(\frac{f_{ck}}{20}\right)^m$												
Concrete strength class C25/30 to C50/60			$N_{Rk,p} = \psi_c \cdot N_{Rk,p (C20/25)}$									
Exponent m	cracked	m	[-]	0,41	0,35	0,50	0,50	0,50	0,50	0,50	0,39	0,39
	uncracked	m	[-]	0,35	0,50	0,38	0,50	0,50	0,30	0,50	0,50	0,50
Splitting failure												
Case 1	Characteristic resistance	$N^0_{Rk,sp}$	[kN]	$\min(N_{Rk,p}; N^0_{Rk,c})$								
	Characteristic edge distance	$c_{cr,sp}$	[mm]	60	80	120	100	120	145	115	140	160
	Characteristic spacing	$s_{cr,sp}$	[mm]	120	160	240	200	240	290	230	280	320
Case 2	Characteristic resistance	$N^0_{Rk,sp}$	[kN]	3)	2,5	5,5	5,5	8,0	11,0	7,0	15,0	20,0
	Characteristic edge distance	$c_{cr,sp}$	[mm]	3)	58	84	64	82	98	80	114	130
	Characteristic spacing	$s_{cr,sp}$	[mm]	3)	116	168	128	164	196	160	224	260
Concrete cone failure												
Effective anchorage depth	h_{ef}	[mm]	25	34	42	32	41	49	40	57	65	
Factor	cracked	$k_{cr,N}$	[-]	7,7								
	uncracked	$k_{ucr,N}$	[-]	11,0								
Characteristic edge distance	$c_{cr,N}$	[mm]	$1,5 \cdot h_{ef}$									
Characteristic spacing	$s_{cr,N}$	[mm]	$3 \cdot h_{ef}$									

¹⁾ Only for statically indeterminate non-structural systems (multiple use) according to EN 1992-4:2018, in dry internal conditions.

²⁾ In absence of other national regulations.

³⁾ No performance assessed.

Concrete Screw BSZ2

Performances
Characteristic values for **tension load**

Annex C1

Table C2: Characteristic values for shear load under static or quasi static action

Screw size			BSZ2 6			BSZ2 8			BSZ2 10						
Nominal embedment depth	h_{nom}	[mm]	35 ¹⁾	45	55	45	55	65	55	75	85				
Installation factor	γ_{inst}	[-]	1,0												
Steel failure <u>without</u> lever arm															
Characteristic resistance	$V^0_{Rk,s}$	[kN]	7,0			13,5			17,0			22,5		34,0	
Partial factor ²⁾	$\gamma_{Ms,V}$	[-]	1,25												
Ductility factor	k_7	[-]	0,8												
Steel failure <u>with</u> lever arm															
Characteristic bending resistance	$M^0_{Rk,s}$	[Nm]	10,9			26,0			56,0						
Concrete pry-out failure															
Pry-out factor	k_8	[-]	1,0	1,6	2,1	2,8	2,5								
Concrete edge failure															
Effective length of fastener in shear loading	$l_f = h_{nom}$	[mm]	35	45	55	45	55	65	55	75	85				
Outside diameter of anchor	d_{nom}	[mm]	6			8			10						

¹⁾ Only for statically indeterminate non-structural systems (multiple use) according to EN 1992-4:2018, in dry internal conditions.

²⁾ In absence of other national regulations

Concrete Screw BSZ2

Performances
Characteristic values for **shear load**

Annex C2

Table C3: Characteristic values for seismic loading, performance category C1

Screw size			BSZ2 6		BSZ2 8		BSZ2 10		
Nominal embedment depth	h_{nom}	[mm]	45	55	45	65	55	85	
Installation factor	γ_{inst}	[-]	1,0						
Tension load (all types)									
Steel failure									
Characteristic resistance	$N_{Rk,s,C1}$	[kN]	14,0		27,0		45,0		
Partial factor ¹⁾	$\gamma_{Ms,N}$	[-]	1,5						
Pull-out failure									
Characteristic resistance	$N_{Rk,p,C1}$	[kN]	1,5	3,0	3,0	8,5	6,0	17,0	
Concrete cone failure									
Effective anchorage depth	h_{ef}	[mm]	34	42	32	49	40	65	
Edge distance	$c_{cr,N}$	[mm]	$1,5 \cdot h_{ef}$						
Spacing	$s_{cr,N}$	[mm]	$3 \cdot h_{ef}$						
Shear load (Type : B, S, SK, LK)									
Steel failure without lever arm									
Characteristic resistance	Type B, S, LK	$V_{Rk,s,C1}$	[kN]	3,5	4,0	8,0	10,0	14,0	16,0
	Type SK	$V_{Rk,s,C1}$	[kN]	2,5	²⁾	4,5	7,0	14,0	10,0
Partial factor ¹⁾	$\gamma_{Ms,V}$	[-]	1,25						
with filling of annular gap	α_{gap}	[-]	1,0						
without filling of annular gap	α_{gap}	[-]	0,5						
Concrete pry-out failure									
Pry-out factor	k_8	[-]	1,6		2,1		2,8		2,5
Concrete edge failure									
Effective length of anchor	$l_f = h_{nom}$	[mm]	45	55	45	65	55	85	
Outside diameter of anchor	d_{nom}	[mm]	6		8		10		

¹⁾ In absence of other national regulations

²⁾ No performance assessed

Concrete Screw BSZ2

Performances
Characteristic values for seismic loading

Annex C3

Table C4: Characteristic values under fire exposure

Screw size			BSZ2 6			BSZ2 8			BSZ2 10			
Nominal anchorage depth	h_{nom}	[mm]	35 ¹⁾	45	55	45	55	65	55	75	85	
Steel failure (tension and shear resistance)												
Characteristic resistance	R30	$N_{Rk,s,fi}$ = $V_{Rk,s,fi}$	[kN]	0,9			2,4			4,4		
	R60			0,8			1,7			3,3		
	R90			0,6			1,1			2,3		
	R120			0,4			0,7			1,7		
Steel failure <u>with</u> lever arm												
Characteristic bending resistance	R30	$M^0_{Rk,s,fi}$	[Nm]	0,7			2,4			5,9		
	R60			0,6			1,8			4,5		
	R90			0,5			1,2			3,0		
	R120			0,3			0,9			2,3		
Pull-out failure												
Characteristic resistance	R30-R90	$N_{Rk,p,fi}$	[kN]	0,6	0,4	0,8	0,8	1,4	2,0	1,5	3,3	4,3
	R120	$N_{Rk,p,fi}$	[kN]	0,5	0,3	0,6	0,6	1,1	1,6	1,2	2,6	3,4
Concrete cone failure												
Characteristic resistance	R30-R90	$N^0_{Rk,c,fi}$	[kN]	0,5	1,2	2,0	1,0	1,9	2,9	1,7	4,2	5,9
	R120	$N^0_{Rk,c,fi}$	[kN]	0,4	0,9	1,6	0,8	1,5	2,3	1,4	3,4	4,7
Edge distance	$c_{cr,fi}$	[mm]	$2 \cdot h_{ef}$									
In case of fire attack from more than one side, the minimum edge distance shall be ≥ 300 mm												
Spacing	$s_{cr,fi}$	[mm]	$4 \cdot h_{ef}$									
Concrete pry-out failure												
Pry-out factor	k_8	[-]	1,0	1,6	2,1	2,8	2,5					
The anchorage depth has to be increased for wet concrete by at least 30 mm compared to the given values.												

¹⁾ Only for statically indeterminate non-structural systems (multiple use) according to EN 1992-4:2018, in dry internal conditions.

Concrete Screw BSZ2

Performances
Characteristic values under **fire exposure**

Annex C4

Table C5: Displacements under static or quasi-static loads

Screw size			BSZ2 6		BSZ2 8			BSZ2 10			
Nominal embedment depth	h_{nom}	[mm]	45	55	45	55	65	55	75	85	
Tension load											
cracked concrete	Tension load	N	[kN]	0,72	1,45	1,63	2,74	4,06	3,04	6,22	8,46
	Displacement	δ_{N0}	[mm]	0,19	0,27	0,27	0,53	0,45	0,26	0,58	0,61
		$\delta_{N\infty}$	[mm]	0,55	0,84	0,49	0,66	0,61	0,69	0,92	1,10
uncracked concrete	Tension load	N	[kN]	2,11	4,07	4,24	5,97	8,03	5,42	9,17	12,28
	Displacement	δ_{N0}	[mm]	0,42	0,43	0,33	0,49	0,58	0,84	0,62	0,79
		$\delta_{N\infty}$	[mm]	0,42	0,43	0,58			0,79		
Shear load											
Shear load	V	[kN]	3,3		8,6			16,2			
Displacement	δ_{V0}	[mm]	1,55		2,7			2,7			
	$\delta_{V\infty}$	[mm]	3,1		4,1			4,3			

Concrete Screw BSZ2

Performances
Displacements

Annex C5