

Public-law institution jointly founded by the federal states and the Federation

European Technical Assessment Body
for construction products



European Technical Assessment

ETA-19/0201
of 18 November 2025

English translation prepared by DIBt - Original version in German language

General Part

Technical Assessment Body issuing the European Technical Assessment:

Deutsches Institut für Bautechnik

Trade name of the construction product

Chemofast Injection System EP 1000 for concrete

Product family
to which the construction product belongs

Bonded fasteners and bonded expansion fasteners for use in concrete
(Alternative drilling methods, seismic and fire in steel fibre reinforced concrete, variable working life, time-to-failure assessment)

Manufacturer

CHEMOFAST Anchoring GmbH
Hanns-Martin-Schleyer-Straße 23
47877 Willich
DEUTSCHLAND

Manufacturing plant

CHEMOFAST Anchoring GmbH
Hanns-Martin-Schleyer-Straße 23
47877 Willich
DEUTSCHLAND

This European Technical Assessment contains

49 pages including 3 annexes which form an integral part of this assessment

This European Technical Assessment is issued in accordance with Regulation (EU) No 305/2011, on the basis of

EAD 330499-02-0601-v01, Edition 12/2024

This version replaces

ETA-19/0201 issued on 5 November 2025

The European Technical Assessment is issued by the Technical Assessment Body in its official language. Translations of this European Technical Assessment in other languages shall fully correspond to the original issued document and shall be identified as such.

Communication of this European Technical Assessment, including transmission by electronic means, shall be in full. However, partial reproduction may only be made with the written consent of the issuing Technical Assessment Body. Any partial reproduction shall be identified as such.

This European Technical Assessment may be withdrawn by the issuing Technical Assessment Body, in particular pursuant to information by the Commission in accordance with Article 25(3) of Regulation (EU) No 305/2011.

Specific part

1 Technical description of the product

The "Chemofast Injection system EP 1000 for concrete" is a bonded anchor consisting of a cartridge with injection mortar Chemofast Injection mortar EP 1000 and a steel element according to Annex A 3 to Annex A 5.

The steel element is placed into a drilled hole filled with injection mortar and is anchored via the bond between metal part, injection mortar and concrete.

The product description is given in Annex A.

2 Specification of the intended use in accordance with the applicable European Assessment Document

The performances given in Section 3 are only valid if the anchor is used in compliance with the specifications and conditions given in Annex B.

The verifications and assessment methods on which this European Technical Assessment is based lead to the assumption of a working life according to Annex B2, use conditions. The indications given on the working life cannot be interpreted as a guarantee given by the producer, but are to be regarded only as a means for choosing the right products in relation to the expected economically reasonable working life of the works.

3 Performance of the product and references to the methods used for its assessment

3.1 Mechanical resistance and stability (BWR 1)

Essential characteristic	Performance
Characteristic resistance to tension load (static and quasi-static loading)	See Annex C 1 to C 6, C 8 to C 11, C 13 to C 16, B 3
Characteristic resistance to shear load (static and quasi-static loading)	See Annex C 1, C 7, C 12, C 17
Displacements under short-term and long-term loading	See Annex C 18 to C 20
Characteristic resistance and displacements for seismic performance categories C1 and C2	See Annex C 21 to C 28

3.2 Safety in case of fire (BWR 2)

Essential characteristic	Performance
Reaction to fire	Class A1
Resistance to fire	See Annex C 29 to C 31

3.3 Hygiene, health and the environment (BWR 3)

Essential characteristic	Performance
Content, emission and/or release of dangerous substances	No performance assessed

4 Assessment and verification of constancy of performance (AVCP) system applied, with reference to its legal base

In accordance with the European Assessment Document EAD 330499-02-0601-v01 the applicable European legal act is: [96/582/EC].

The system to be applied is: 1

5 Technical details necessary for the implementation of the AVCP system, as provided for in the applicable European Assessment Document

Technical details necessary for the implementation of the AVCP system are laid down in the control plan deposited at Deutsches Institut für Bautechnik.

Issued in Berlin on 18 November 2025 by Deutsches Institut für Bautechnik

Dipl.-Ing. Beatrix Wittstock
Head of Section

beglaubigt:
Stiller

Installation threaded rod M8 up to M30

prepositioned installation or
push through installation (annular gap filled with mortar)

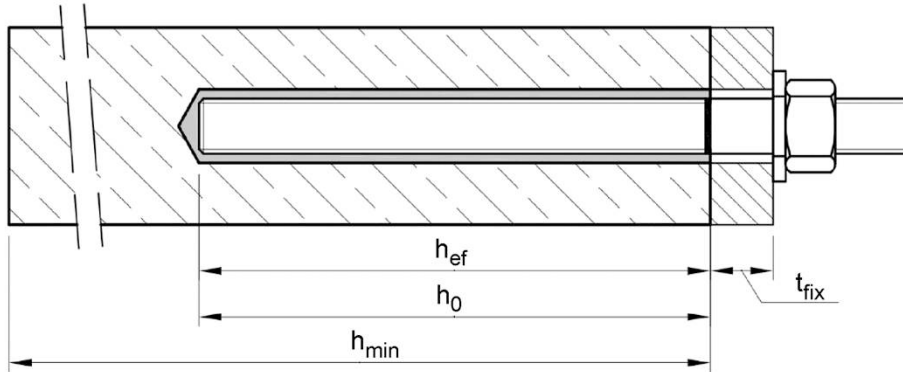

Installation reinforcing bar Ø8 up to Ø40

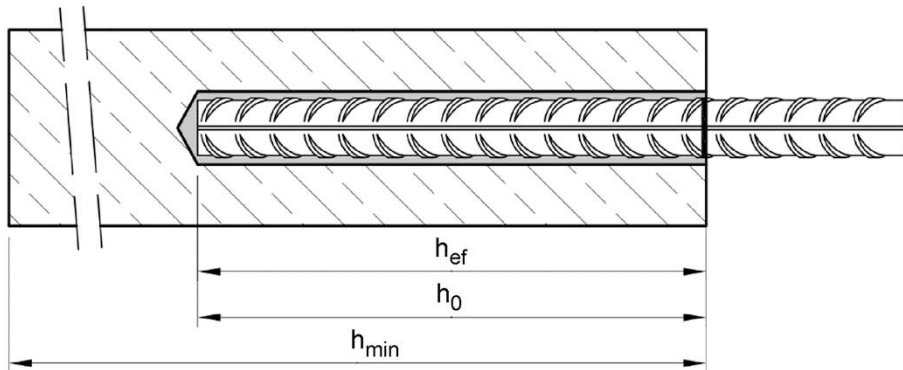

Installation internal threaded anchor rod IG-M6 up to IG-M20

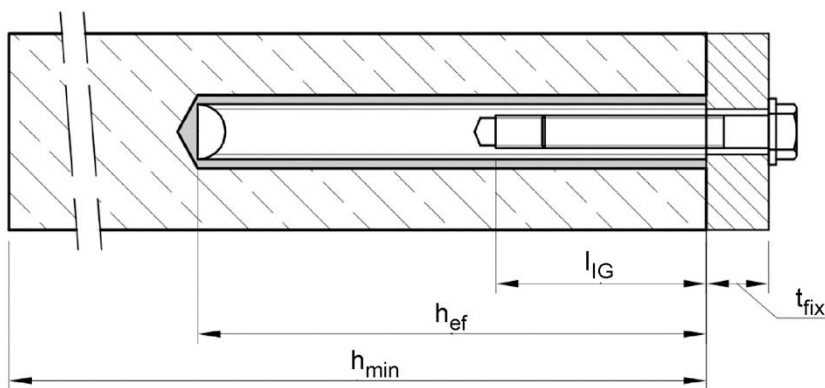

t_{fix} = thickness of fixture
 h_{ef} = effective embedment depth
 h_{min} = minium thickness of member

h_0 = drill hole depth
 l_{IG} = thread engagement length

Chemofast Injection system EP 1000 for concrete

Product description
Installed condition

Annex A 1

Cartridge system

Side-by-Side Cartridge:

440 ml, 500 ml up to 540 ml, 585 ml
and 1400 ml

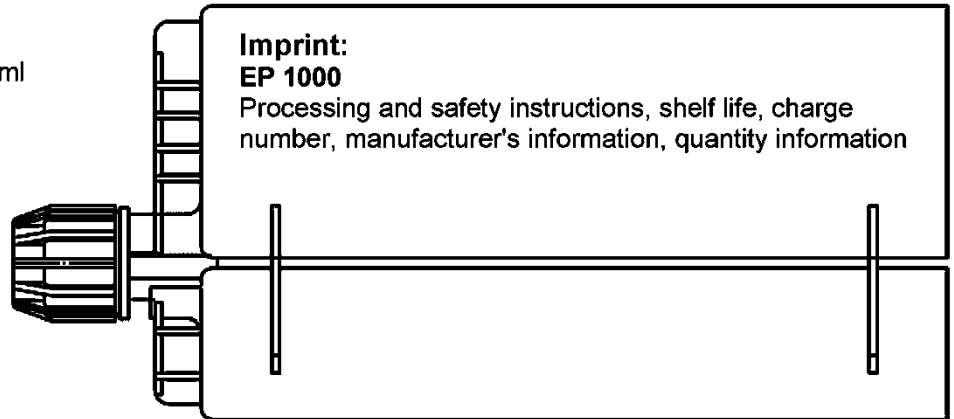

Static mixer PM-19E

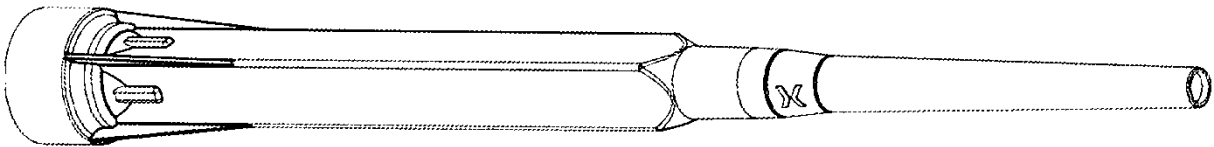

Piston plug VS and mixer extension VL

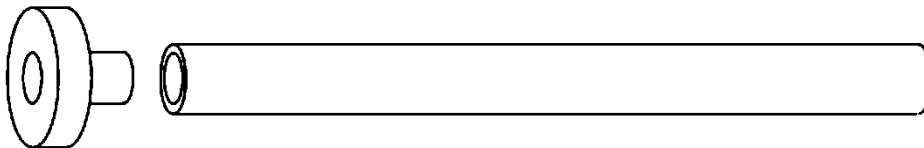

Chemofast Injection system EP 1000 for concrete

Product description
Injection system

Annex A 2

Threaded rod M8 up to M30 with washer and hexagon nut

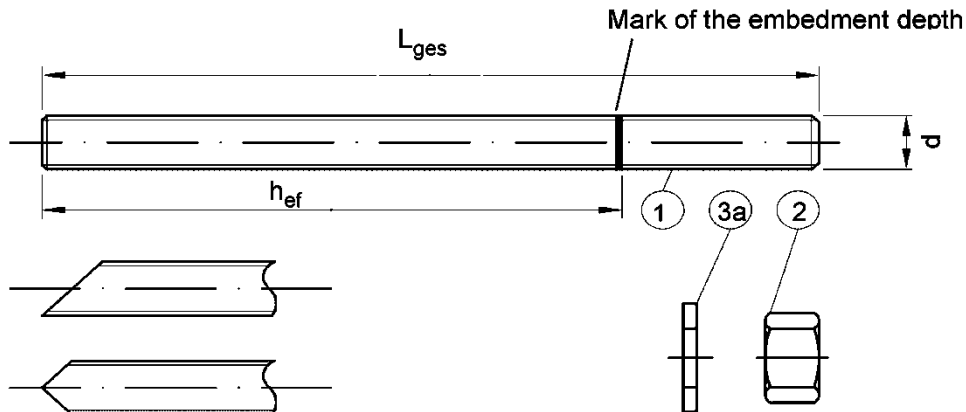

Commercial standard rod with:

- Materials, dimensions and mechanical properties acc. to Table A1
- Inspection certificate 3.1 acc. to EN 10204:2004. The document shall be stored.
- Marking of embedment depth

For hot dip galvanized elements, the requirements with regards to the combination of nuts and rods according to EN ISO 10684:2004+AC:2009 Annex F shall be considered.

Internal threaded rod IG-M6 to IG-M20

Threaded rod or screw

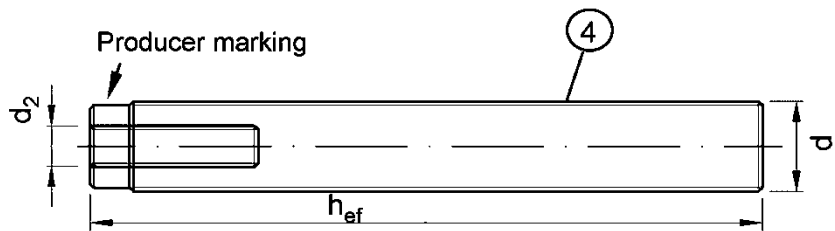
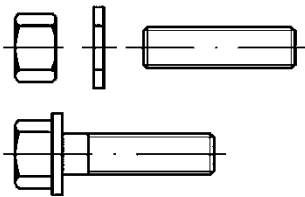

Producer marking: e.g.  M8

 Marking Internal thread (optional)

 Mark

- M8 Thread size (Internal thread)
- A4 additional mark for stainless steel
- HCR additional mark for high-corrosion resistance steel
- 8 additional mark for property class 8.8

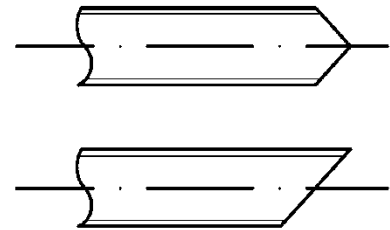

Filling washer VFS

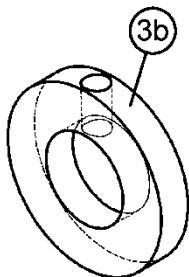

Mixer reduction nozzle MR

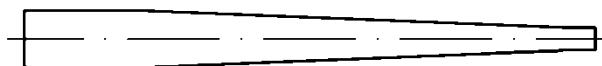

Chemofast Injection system EP 1000 for concrete

Product description

Threaded rod; Internal threaded rod
Filling washer; Mixer reduction nozzle

Annex A 3

Table A1: Materials						
Part	Designation	Material				
Steel, zinc plated (Steel acc. to EN ISO 683-4:2018 or EN 10263:2017)						
- zinc plated $\geq 5 \mu\text{m}$ acc. to EN ISO 4042:2022 or						
- hot-dip galvanised $\geq 40 \mu\text{m}$ acc. to EN ISO 1461:2022 and EN ISO 10684:2004+AC:2009 or						
- sherardized $\geq 45 \mu\text{m}$ acc. to EN ISO 17668:2016						
1	Threaded rod	Property class	Characteristic steel ultimate tensile strength	Characteristic steel yield strength	Elongation at fracture	
		acc. to EN ISO 898-1:2013	4.6	$f_{uk} = 400 \text{ N/mm}^2$	$f_{yk} = 240 \text{ N/mm}^2$	$A_5 > 8\%$
			4.8	$f_{uk} = 400 \text{ N/mm}^2$	$f_{yk} = 320 \text{ N/mm}^2$	$A_5 > 8\%$
			5.6	$f_{uk} = 500 \text{ N/mm}^2$	$f_{yk} = 300 \text{ N/mm}^2$	$A_5 > 8\%$
			5.8	$f_{uk} = 500 \text{ N/mm}^2$	$f_{yk} = 400 \text{ N/mm}^2$	$A_5 > 8\%$
8.8	$f_{uk} = 800 \text{ N/mm}^2$	$f_{yk} = 640 \text{ N/mm}^2$	$A_5 \geq 12\%^{3)}$			
2	Hexagon nut	acc. to EN ISO 898-2:2022	4	for anchor rod class 4.6 or 4.8		
			5	for anchor rod class 5.6 or 5.8		
			8	for anchor rod class 8.8		
3a	Washer	Steel, zinc plated, hot-dip galvanised or sherardized (e.g.: EN ISO 887:2006, EN ISO 7089:2000, EN ISO 7093:2000 or EN ISO 7094:2000)				
3b	Filling washer	Steel, zinc plated, hot-dip galvanised or sherardized				
4	Internal threaded anchor rod	Property class	Characteristic steel ultimate tensile strength	Characteristic steel yield strength	Elongation at fracture	
		acc. to EN ISO 898-1:2013	5.8	$f_{uk} = 500 \text{ N/mm}^2$	$f_{yk} = 400 \text{ N/mm}^2$	$A_5 > 8\%$
			8.8	$f_{uk} = 800 \text{ N/mm}^2$	$f_{yk} = 640 \text{ N/mm}^2$	$A_5 > 8\%$
Stainless steel A2 (Material 1.4301 / 1.4307 / 1.4311 / 1.4567 or 1.4541, acc. to EN 10088-1:2023)						
Stainless steel A4 (Material 1.4401 / 1.4404 / 1.4571 / 1.4362 or 1.4578, acc. to EN 10088-1:2023)						
High corrosion resistance steel (Material 1.4529 or 1.4565, acc. to EN 10088-1:2023)						
1	Threaded rod ¹⁾⁴⁾	Property class	Characteristic steel ultimate tensile strength	Characteristic steel yield strength	Elongation at fracture	
		acc. to EN ISO 3506-1:2020	50	$f_{uk} = 500 \text{ N/mm}^2$	$f_{yk} = 210 \text{ N/mm}^2$	$A_5 \geq 8\%$
			70	$f_{uk} = 700 \text{ N/mm}^2$	$f_{yk} = 450 \text{ N/mm}^2$	$A_5 \geq 12\%^{3)}$
80	$f_{uk} = 800 \text{ N/mm}^2$		$f_{yk} = 600 \text{ N/mm}^2$	$A_5 \geq 12\%^{3)}$		
2	Hexagon nut ¹⁾⁴⁾	acc. to EN ISO 3506-1:2020	50	for anchor rod class 50		
			70	for anchor rod class 70		
			80	for anchor rod class 80		
3a	Washer	A2: Material 1.4301 / 1.4307 / 1.4311 / 1.4567 or 1.4541, acc. to EN 10088-1:2023 A4: Material 1.4401 / 1.4404 / 1.4571 / 1.4362 or 1.4578, acc. to EN 10088-1:2023 HCR: Material 1.4529 or 1.4565, acc. to EN 10088-1:2023 (e.g.: EN ISO 887:2006, EN ISO 7089:2000, EN ISO 7093:2000 or EN ISO 7094:2000)				
3b	Filling washer	Stainless steel A4, High corrosion resistance steel				
4	Internal threaded anchor rod ¹⁾²⁾	Property class	Characteristic steel ultimate tensile strength	Characteristic steel yield strength	Elongation at fracture	
		acc. to EN ISO 3506-1:2020	50	$f_{uk} = 500 \text{ N/mm}^2$	$f_{yk} = 210 \text{ N/mm}^2$	$A_5 > 8\%$
			70	$f_{uk} = 700 \text{ N/mm}^2$	$f_{yk} = 450 \text{ N/mm}^2$	$A_5 > 8\%$
1) Property class 70 or 80 for anchor rods and hexagon nuts up to M24 and Internal threaded anchor rods up to IG-M16						
2) for IG-M20 only property class 50						
3) $A_5 > 8\%$ fracture elongation if no use for seismic performance category C2						
4) Property class 80 only for stainless steel A4 and HCR						
Chemofast Injection system EP 1000 for concrete						
Product description Materials threaded rod, Internal threaded anchor rod and filling washer				Annex A 4		

Reinforcing bar: $\varnothing 8$ up to $\varnothing 40$

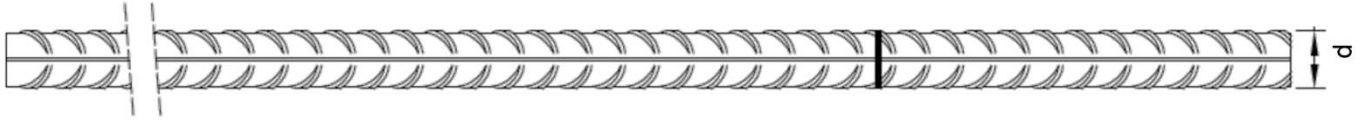

Minimum value of related rip area $f_{R,min}$ according to EN 1992-1-1:2004+AC:2010

Rib height of the bar shall be in the range $0,05d \leq h_{rib} \leq 0,07d$

(d: Nominal diameter of the bar; h_{rib} : Rib height of the bar)

Table A2: Materials Reinforcing bar

Part	Designation	Material
Rebar		
1	Reinforcing steel according to EN 1992-1-1:2004+AC:2010, Annex C	Bars and rebars from ring class B or C f_{yk} and k according to NDP or NCI according to EN 1992-1-1/NA $f_{uk} = f_{tk} = k \cdot f_{yk}$

Chemofast Injection system EP 1000 for concrete

Product description
Materials reinforcing bar

Annex A 5

Specification of the intended use				
Fasteners subject to (Static and quasi-static loads):				
	Working life 50 years		Working life 100 years	
	in concrete C20/25 to C90/105 without fibers and in concrete C20/25 to C50/60 with fibers ⁵⁾			
Base material	uncracked concrete	cracked concrete	uncracked concrete	cracked concrete
HD: Hammer drilling HDB: Hammer drilling with hollow drill bit CD: Compressed air drilling	M8 to M30, Ø8 to Ø32, IG-M6 to IG-M20		M8 to M30, Ø8 to Ø32, IG-M6 to IG-M20	
HD: Hammer drilling CD: Compressed air drilling	Ø36 to Ø40	No performance assessed	Ø36 to Ø40	No performance assessed
DD: Diamond drilling	M8 to M30, Ø8 to Ø40, IG-M6 to IG-M20	M16 to M30 ⁴⁾ IG-M10 to IG-M20 ⁴⁾	M8 to M30, Ø8 to Ø40, IG-M6 to IG-M20	No performance assessed
Temperature Range:	I: - 40°C to +40°C ¹⁾ II: - 40°C to +72°C ²⁾ III: - 40°C to +80°C ³⁾		I: - 40°C to +40°C ¹⁾ II: - 40°C to +72°C ²⁾ III: - 40°C to +80°C ³⁾	
Fasteners subject to (seismic action):				
	Performance Category C1		Performance Category C2	
Base material	Cracked and uncracked concrete C20/25 to C50/60 with and without fibers ⁵⁾			
HD: Hammer drilling HDB: Hammer drilling with hollow drill bit CD: Compressed air drilling	M8 to M30, Ø8 to Ø32		M12 to M30	
DD: Diamond drilling	No performance assessed		No performance assessed	
Temperature Range:	I: - 40°C to +40°C ¹⁾ II: - 40°C to +72°C ²⁾ III: - 40°C to +80°C ³⁾		I: - 40°C to +40°C ¹⁾ II: - 40°C to +72°C ²⁾ III: - 40°C to +80°C ³⁾	
Fasteners subject to (fire exposure):				
Base material	Cracked and uncracked concrete C20/25 to C90/105 without fibers and in cracked and uncracked concrete C20/25 to C50/60 with fibers ⁵⁾			
HD: Hammer drilling HDB: Hammer drilling with hollow drill bit CD: Compressed air drilling	M8 to M30, Ø8 to Ø32, IG-M6 to IG-M20			
DD: Diamond drilling	No performance assessed			
Temperature Range:	I: - 40°C to +40°C ¹⁾ II: - 40°C to +72°C ²⁾ III: - 40°C to +80°C ³⁾			
¹⁾ (max. long-term temperature +24°C and max. short-term temperature +40°C) ²⁾ (max. long-term temperature +50°C and max. short-term temperature +72°C) ³⁾ (max. long-term temperature +60°C and max. short-term temperature +80°C) ⁴⁾ only C20/25 to C50/60 and without fibers ⁵⁾ with fibers only by hammer (HD), hollow (HDB) or compressed air drilling mode (CD)				
Chemofast Injection system EP 1000 for concrete				Annex B 1
Intended use Specifications				

Base materials:

- Compacted, reinforced or unreinforced normal weight concrete with strength classes C20/25 to C90/105 according to EN 206:2013 + A2:2021.
- Steel fiber reinforced concrete according to EN 206:2013 + A2:2021 with steel fibers according to EN 14889-1:2006, section 5, group 1, with a maximum fiber content of 80kg/m³.

Use conditions (Environmental conditions):

For working life for at least 50 and / or 100 years

- Structures subject to dry internal conditions (all materials).
- For all other conditions according to EN 1993-1-4:2006 + A1:2015 corresponding to corrosion resistance class:
 - Stainless steel Stahl A2 according to Annex A 4, Table A1: CRC II
 - Stainless steel Stahl A4 according to Annex A 4, Table A1: CRC III
 - High corrosion resistance steel HCR according to Annex A 4, Table A1: CRC V

For variable working life

- Structures subject to internal and external conditions: Classification of atmospheric corrosivity, determination and estimation C1-CX according to EN ISO 9223:2012-02 Table C.1 for a variable working life according to Table B1.
 - Carbon steel, hot dip galvanized according to EN ISO 10684:2004 + AC:2009 with mean thickness $\geq 50 \mu\text{m}$

Table B1: Variable working life

Corrosivity category ¹⁾	Corrosivity	Working life (years)
C1	Very low	50
C2	Low	50
C3	Medium	25
C4	High	12,5
C5	Very High	5
CX	Extreme	2

¹⁾ Corrosivity categories according to EN ISO 9233:2012-02, Table C.1

Design:

- Verifiable calculation notes and drawings are prepared taking account of the loads to be anchored. The position of the fastener is indicated on the design drawings (e. g. position of the fastener relative to reinforcement or to supports, etc.).
- Fasteners are designed under the responsibility of an engineer experienced in fasteners and concrete work.
- The fasteners are designed in accordance to EN 1992-4:2018 and Technical Report TR 055, Edition February 2018.
- Fasteners in steel fiber reinforced concrete may be designed in accordance with EN 1992-4:2018. All performance parameters are to be applied as for normal concrete of strength classes C20/25 to C50/60 without fibers.
- The fasteners under fire exposure are designed in accordance to Technical Report TR 082, Edition June 2023.

Installation:

- Dry, wet concrete or flooded bore holes (not sea-water).
- Hole drilling by hammer (HD), hollow (HDB), compressed air (CD) or diamond drill mode (DD).
- Overhead installation allowed.
- Fastener installation carried out by appropriately qualified personnel and under the supervision of the person responsible for technical matters of the site.

Chemofast Injection system EP 1000 for concrete	Annex B 2
Intended use Specifications (Continued)	

Table B2: Installation parameters for threaded rod

Threaded rod			M8	M10	M12	M16	M20	M24	M27	M30
Diameter of element	$d = d_{nom}$	[mm]	8	10	12	16	20	24	27	30
Nominal drill hole diameter	d_0	[mm]	10	12	14	18	22	28	30	35
Effective embedment depth	$h_{ef,min}$	[mm]	60	60	70	80	90	96	108	120
	$h_{ef,max}$	[mm]	160	200	240	320	400	480	540	600
Diameter of clearance hole in the fixture	Prepositioned installation $d_f \leq$	[mm]	9	12	14	18	22	26	30	33
	Push through installation d_f	[mm]	12	14	16	20	24	30	33	40
Maximum installation torque	$\max T_{inst}$	[Nm]	10	20	40 ¹⁾	60	100	170	250	300
Minimum thickness of member	h_{min}	[mm]	$h_{ef} + 30 \text{ mm} \geq 100 \text{ mm}$			$h_{ef} + 2d_0$				
Minimum spacing	s_{min}	[mm]	40	50	60	75	95	115	125	140
Minimum edge distance	c_{min}	[mm]	35	40	45	50	60	65	75	80

¹⁾ Maximum installation torque for M12 with steel Grade 4.6 is 35 Nm

Table B3: Installation parameters for reinforcing bar

Reinforcing bar			$\varnothing 8^1)$	$\varnothing 10^1)$	$\varnothing 12^1)$	$\varnothing 14$	$\varnothing 16$	$\varnothing 20$	$\varnothing 24^1)$	$\varnothing 25^1)$	$\varnothing 28$	$\varnothing 32$	$\varnothing 36$	$\varnothing 40$
Diameter of element	$d = d_{nom}$	[mm]	8	10	12	14	16	20	24	25	28	32	36	40
Nominal drill hole diameter	d_0	[mm]	10 12	12 14	14 16	18	20	25	30 32	30 32	35	40	45	52/55
Effective embedment depth	$h_{ef,min}$	[mm]	60	60	70	75	80	90	96	100	112	128	144	160
	$h_{ef,max}$	[mm]	160	200	240	280	320	400	480	500	560	640	720	800
Minimum thickness of member	h_{min}	[mm]	$h_{ef} + 30 \text{ mm} \geq 100 \text{ mm}$			$h_{ef} + 2d_0$								
Minimum spacing	s_{min}	[mm]	40	50	60	70	75	95	120	120	130	150	180	200
Minimum edge distance	c_{min}	[mm]	35	40	45	50	50	60	70	70	75	85	180	200

¹⁾ both nominal drill hole diameter can be used

Table B4: Installation parameters for Internal threaded anchor rod

Internal threaded anchor rod			IG-M6	IG-M8	IG-M10	IG-M12	IG-M16	IG-M20
Internal diameter of anchor rod	d_2	[mm]	6	8	10	12	16	20
Outer diameter of anchor rod ¹⁾	$d = d_{nom}$	[mm]	10	12	16	20	24	30
Nominal drill hole diameter	d_0	[mm]	12	14	18	22	28	35
Effective embedment depth	$h_{ef,min}$	[mm]	60	70	80	90	96	120
	$h_{ef,max}$	[mm]	200	240	320	400	480	600
Diameter of clearance hole in the fixture	$d_f \leq$	[mm]	7	9	12	14	18	22
Maximum installation torque	$\max T_{inst}$	[Nm]	10	10	20	40	60	100
Thread engagement length min/max	l_{IG}	[mm]	8/20	8/20	10/25	12/30	16/32	20/40
Minimum thickness of member	h_{min}	[mm]	$h_{ef} + 30 \text{ mm} \geq 100 \text{ mm}$			$h_{ef} + 2d_0$		
Minimum spacing	s_{min}	[mm]	50	60	75	95	115	140
Minimum edge distance	c_{min}	[mm]	40	45	50	60	65	80

¹⁾ With metric threads

Chemofast Injection system EP 1000 for concrete

Intended use
Installation parameters

Annex B 3

Table B5: Parameter cleaning and installation tools

Threaded Rod	Re-inforcing bar	Internal threaded anchor rod	Drill bit - Ø		Brush - Ø	d _{b,min} min. Brush - Ø	Piston plug	Installation direction and use of piston plug		
			DD	HD, HDB, CD				↓	→	↑
[mm]	[mm]	[mm]	[mm]		[mm]	[mm]				
M8	8		10		RB10	11,5		No plug required		
M10	8 / 10	IG-M6	12		RB12	13,5				
M12	10 / 12	IG-M8	14		RB14	15,5				
-	12	-	16		RB16	17,5				
M16	14	IG-M10	18		RB18	20,0	VS18	h _{ef} > 250 mm	h _{ef} > 250 mm	all
-	16	-	20		RB20	22,0	VS20			
M20	-	IG-M12	22		RB22	24,0	VS22			
-	20	-	25		RB25	27,0	VS25			
M24	-	IG-M16	28		RB28	30,0	VS28			
M27	24 / 25	-	30		RB30	31,8	VS30			
-	24 / 25	-	32		RB32	34,0	VS32			
M30	28	IG-M20	35		RB35	37,0	VS35			
-	32	-	40		RB40	43,5	VS40			
-	36	-	45		RB45	47,0	VS45			
-	40	-	52	-	RB52	54,0	VS52	all	all	all
-		-	-	55	RB55	58,5	VS55			

Cleaning and installation tools

HDB – Hollow drill bit system



The hollow drill system consists of Heller Duster Expert hollow drill bit or a hollow drill bit with equivalent performance and a class M hoover with a minimum negative pressure of 253 hPa and a flow rate of minimum 150 m³/h (42 l/s).

Compressed air tool

(min 6 bar)



Centring aid

-Cap



-Ring



Brush RB



Piston Plug VS



Brush extension RBL



Chemofast Injection system EP 1000 for concrete

Intended use
Cleaning and installation tools

Annex B 4

Table B6: Installation parameters Centring aid

Threaded rod		M10	M12	M16	M20	M24
Internal threaded anchor rod		IG-M6	IG-M8	IG-M10	IG-M12	IG-M16
Centring aid -Ring / -Cap		-M10	-M12	-M16	-M20	-M24
Centring aid -Ring	h_{Ring} [mm]	6,5	8,0	9,0	9,0	12,0
Centring aid -Cap	h_{Cap} [mm]	8,0	10,0	12,0	14,0	16,0
Drill hole depth	h_0 [mm]	$h_0 \geq h_{nom} + 3 \text{ mm}$				
Minimum thickness of member	h_{min} [mm]	$h_{nom} + 30 \text{ mm} \geq 100 \text{ mm}$			$h_{nom} + 2d_0$	

The effective embedment depth h_{ef} is reduced by the height all centering ring used.

$$h_{ef} = h_{nom} - h_{Cap} - n \cdot h_{Ring} \geq h_{ef,min} \quad n = \text{number of used centering rings}$$

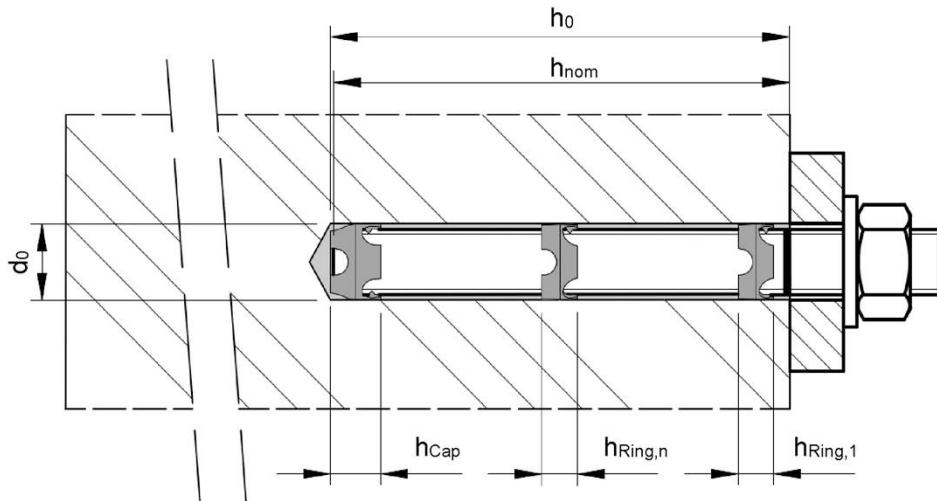

Table B7: Working and curing time

Temperature in base material		Maximum working time	Minimum curing time ¹⁾
T		t_{work}	t_{cure}
+ 0 °C	to + 4 °C	80 min	144 h
+ 5 °C	to + 9 °C	80 min	48 h
+ 10 °C	to + 14 °C	60 min	28 h
+ 15 °C	to + 19 °C	40 min	18 h
+ 20 °C	to + 24 °C	30 min	12 h
+ 25 °C	to + 34 °C	12 min	9 h
+ 35 °C	to + 39 °C	8 min	6 h
+ 40 °C		8 min	4 h
Cartridge temperature		+5 °C to +40 °C	

¹⁾ The minimum curing time is only valid for dry base material.
In wet base material the curing time must be doubled.

Chemofast Injection system EP 1000 for concrete

Intended use
Parameter Centring aid
Working time and curing time

Annex B 5

Installation instructions

Drilling of the bore hole (HD, HDB, CD)

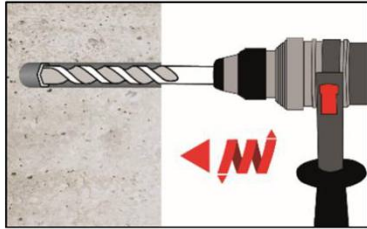

1a. Hammer drilling (HD) / Compressed air drilling (CD)

Drill a hole to the required embedment depth.
Drill bit diameter according to Table B2, B3 or B4.
Aborted drill holes shall be filled with mortar.
Proceed with Step 2.

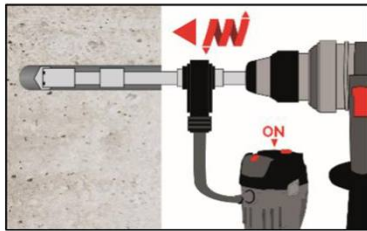

1b. Hollow drill bit system (HDB) (see Annex B 4)

Drill a hole to the required embedment depth.
Drill bit diameter according to Table B2, B3 or B4.
The hollow drilling system removes the dust and cleans the bore hole.
Proceed with Step 3.

Attention! Standing water in the bore hole must be removed before cleaning.

Compressed Air Cleaning (CAC):

All diameter in cracked and uncracked concrete

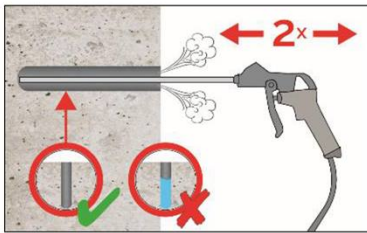

2a. Blow the bore hole clean minimum 2x with compressed air (min. 6 bar, oil-free) (Annex B 4) over the entire embedment depth until return air stream is free of noticeable dust. (If necessary, an extension shall be used.)

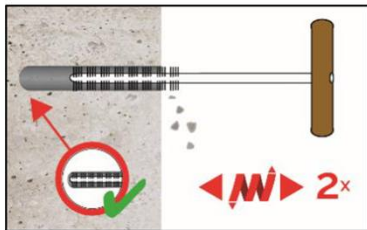

2b. Brush the bore hole minimum 2x with brush RB according to Table B5 over the entire embedment depth in a twisting motion. (If necessary, a brush extension RBL shall be used.)

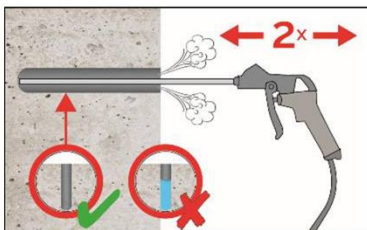

2c. Finally blow the bore hole clean minimum 2x with compressed air (min. 6 bar, oil-free) (Annex B 4) over the entire embedment depth until return air stream is free of noticeable dust. (If necessary, an extension shall be used.)

Cleaned bore hole has to be protected against re-contamination in an appropriate way, If necessary, repeat cleaning process directly before dispensing the mortar. In-flowing water must not contaminate the bore hole again.

Chemofast Injection system EP 1000 for concrete

Intended use
Installation instructions

Annex B 6

Installation instructions (continuation)

Drilling of the bore hole (DD)

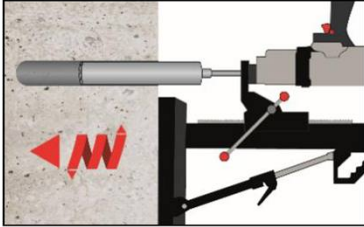

- 1a. Diamond drilling (DD)
Drill a hole to the required embedment depth required
Drill bit diameter according to Table B2, B3 or B4.
Aborted drill holes shall be filled with mortar.
Proceed with Step 2.

Flush & Compressed Air Cleaning (SPCAC):

All diameter in uncracked concrete

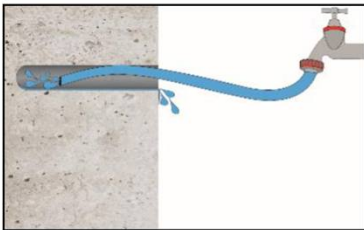

- 2a. Flushing with water until clear water comes out.

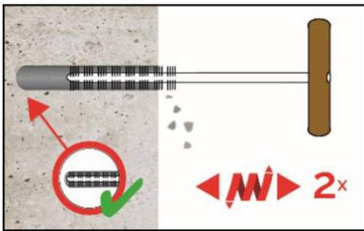

- 2b. Brush the bore hole minimum 2x with brush RB according to Table B5 over the entire embedment depth in a twisting motion. (If necessary, a brush extension RBL shall be used.)

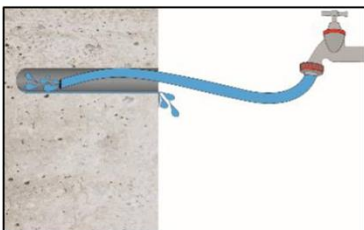

- 2c. Flushing again with water until clear water comes out.

Attention! Standing water in the bore hole must be removed before proceeding.

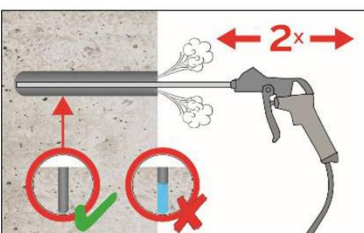

- 2d. Blow the bore hole clean minimum 2x with compressed air (min. 6 bar, oil-free) (Annex B 4) over the entire embedment depth until return air stream is free of noticeable dust. (If necessary, an extension shall be used.)

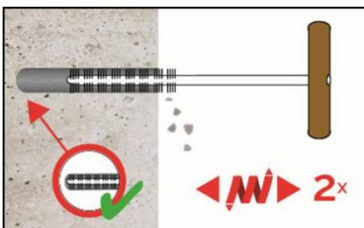

- 2e. Brush the bore hole minimum 2x with brush RB according to Table B5 over the entire embedment depth in a twisting motion. (If necessary, a brush extension RBL shall be used.)

Chemofast Injection system EP 1000 for concrete

Intended use
Installation instructions (continuation)

Annex B 7

Installation instructions (continuation)

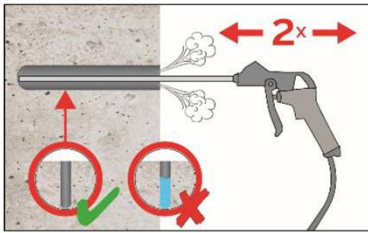

2f. Finally blow the bore hole clean minimum 2x with compressed air (min. 6 bar, oil-free) (Annex B 4) over the entire embedment depth until return air stream is free of noticeable dust. (If necessary, an extension shall be used.)

Cleaned bore hole has to be protected against re-contamination in an appropriate way, If necessary, repeat cleaning process directly before dispensing the mortar. In-flowing water must not contaminate the bore hole again.

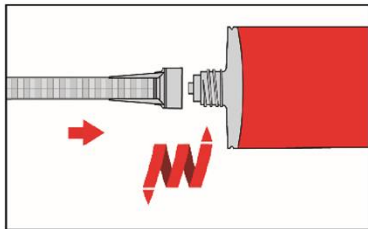

3. Screw on static-mixing nozzle PM-19E and load the cartridge into an appropriate dispensing tool. For every working interruption longer than the maximum working time t_{work} (Annex B 5) as well as for new cartridges, a new static-mixer shall be used.

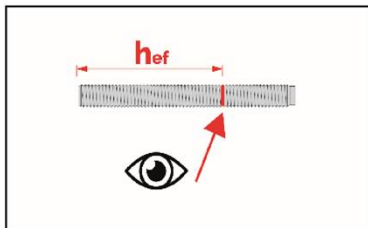

4. Mark embedment depth on the anchor rod. The anchor rod shall be free of dirt, grease, oil or other foreign material.

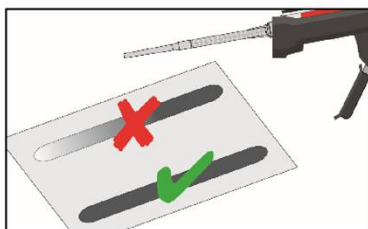

5. Not proper mixed mortar is not sufficient for fastening. Dispense and discard mortar until a uniform grey or red colour is shown (at least 3 full strokes).

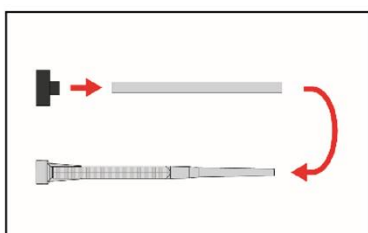

6. Piston plugs VS and mixer nozzle extensions VL shall be used according to Table B5 for the following applications:

- Horizontal and vertical downwards direction: Drill bit- $\varnothing d_0 \geq 18$ mm and embedment depth $h_{ef} > 250$ mm
- Vertical upwards direction: Drill bit- $\varnothing d_0 \geq 18$ mm

Assemble mixing nozzle, mixer extension and piston plug before injecting mortar.

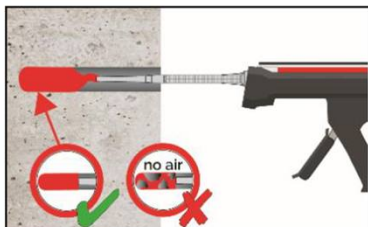

7a. **Injecting mortar without piston plug VS:**

Starting at bottom of the hole and fill the hole up to approximately two-thirds with adhesive. (If necessary, a mixer nozzle extension shall be used.) Slowly withdraw of the static mixing nozzle avoid creating air pockets. Observe the temperature related working time t_{work} (Annex B 5).

Chemofast Injection system EP 1000 for concrete

Intended use
Installation instructions (continuation)

Annex B 8

Installation instructions (continuation)

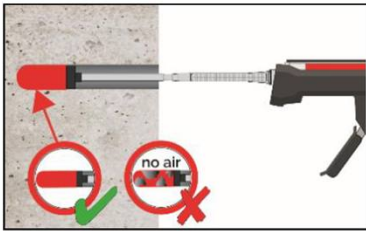

- 7b. Injecting mortar with piston plug VS:**
Starting at bottom of the hole and fill the hole up to approximately two-thirds with adhesive. (If necessary, a mixer nozzle extension shall be used.) During injection the piston plug is pushed out of the bore hole by the back pressure of the mortar.
Observe the temperature related working time t_{work} (Annex B 5).

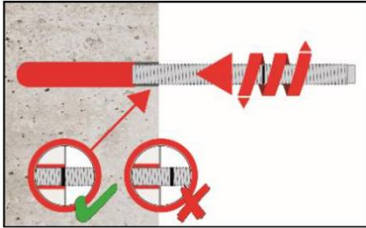

- 8.** Insert the anchor rod while turning slightly up to the embedment mark.

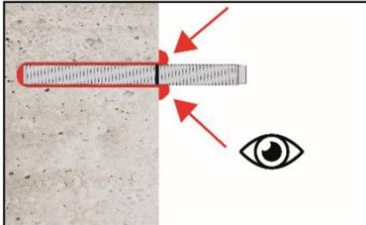

- 9.** Annular gap between anchor rod and base material must be completely filled with mortar. In case of push through installation the annular gap in the fixture must be filled with mortar also.
Otherwise, the installation must be repeated starting from step 7 before the maximum working time t_{work} has expired.



- 10.** For application in vertical upwards direction the anchor rod shall be fixed (e.g. wedges).

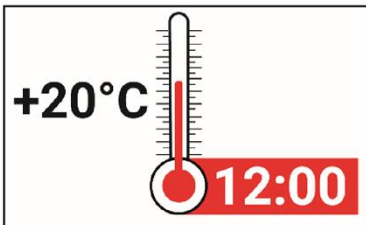

- 11.** Temperature related curing time t_{cure} (Annex B 5) must be observed.
Do not move or load the fastener during curing time.



- 12.** Install the fixture by using a calibrated torque wrench. Observe maximum installation torque (Table B2 or B4).
In case of static requirements (e.g. seismic), fill the annular gap in the fixture with mortar (Annex A 2). Therefore replace the washer by the filling washer VFS and use the mixer reduction nozzle MR.

Chemofast Injection system EP 1000 for concrete

Intended use
Installation instructions (continuation)

Annex B 9

Table C1: Characteristic values for steel tension resistance and steel shear resistance of threaded rods											
Threaded rod			M8	M10	M12	M16	M20	M24	M27	M30	
Cross section area	A_s	[mm ²]	36,6	58	84,3	157	245	353	459	561	
Characteristic tension resistance, Steel failure 1)											
Steel, Property class 4.6 and 4.8	$N_{Rk,s}$	[kN]	15 (13)	23 (21)	34	63	98	141	184	224	
Steel, Property class 5.6 and 5.8	$N_{Rk,s}$	[kN]	18 (17)	29 (27)	42	78	122	176	230	280	
Steel, Property class 8.8	$N_{Rk,s}$	[kN]	29 (27)	46 (43)	67	125	196	282	368	449	
Stainless steel A2, A4 and HCR, class 50	$N_{Rk,s}$	[kN]	18	29	42	79	123	177	230	281	
Stainless steel A2, A4 and HCR, class 70	$N_{Rk,s}$	[kN]	26	41	59	110	171	247	₋₃)	₋₃)	
Stainless steel A4 and HCR, class 80	$N_{Rk,s}$	[kN]	29	46	67	126	196	282	₋₃)	₋₃)	
Characteristic tension resistance, Partial factor 2)											
Steel, Property class 4.6 and 5.6	$\gamma_{Ms,N}$	[-]	2,0								
Steel, Property class 4.8, 5.8 and 8.8	$\gamma_{Ms,N}$	[-]	1,5								
Stainless steel A2, A4 and HCR, class 50	$\gamma_{Ms,N}$	[-]	2,86								
Stainless steel A2, A4 and HCR, class 70	$\gamma_{Ms,N}$	[-]	1,87								
Stainless steel A4 and HCR, class 80	$\gamma_{Ms,N}$	[-]	1,6								
Characteristic shear resistance, Steel failure 1)											
Without lever arm	Steel, Property class 4.6 and 4.8	$V^0_{Rk,s}$	[kN]	9 (8)	14 (13)	20	38	59	85	110	135
	Steel, Property class 5.6 and 5.8	$V^0_{Rk,s}$	[kN]	11 (10)	17 (16)	25	47	74	106	138	168
	Steel, Property class 8.8	$V^0_{Rk,s}$	[kN]	15 (13)	23 (21)	34	63	98	141	184	224
	Stainless steel A2, A4 and HCR, class 50	$V^0_{Rk,s}$	[kN]	9	15	21	39	61	88	115	140
	Stainless steel A2, A4 and HCR, class 70	$V^0_{Rk,s}$	[kN]	13	20	30	55	86	124	₋₃)	₋₃)
	Stainless steel A4 and HCR, class 80	$V^0_{Rk,s}$	[kN]	15	23	34	63	98	141	₋₃)	₋₃)
With lever arm	Steel, Property class 4.6 and 4.8	$M^0_{Rk,s}$	[Nm]	15 (13)	30 (27)	52	133	260	449	666	900
	Steel, Property class 5.6 and 5.8	$M^0_{Rk,s}$	[Nm]	19 (16)	37 (33)	65	166	324	560	833	1123
	Steel, Property class 8.8	$M^0_{Rk,s}$	[Nm]	30 (26)	60 (53)	105	266	519	896	1333	1797
	Stainless steel A2, A4 and HCR, class 50	$M^0_{Rk,s}$	[Nm]	19	37	66	167	325	561	832	1125
	Stainless steel A2, A4 and HCR, class 70	$M^0_{Rk,s}$	[Nm]	26	52	92	232	454	784	₋₃)	₋₃)
	Stainless steel A4 and HCR, class 80	$M^0_{Rk,s}$	[Nm]	30	59	105	266	519	896	₋₃)	₋₃)
Characteristic shear resistance, Partial factor 2)											
Steel, Property class 4.6 and 5.6	$\gamma_{Ms,V}$	[-]	1,67								
Steel, Property class 4.8, 5.8 and 8.8	$\gamma_{Ms,V}$	[-]	1,25								
Stainless steel A2, A4 and HCR, class 50	$\gamma_{Ms,V}$	[-]	2,38								
Stainless steel A2, A4 and HCR, class 70	$\gamma_{Ms,V}$	[-]	1,56								
Stainless steel A4 and HCR, class 80	$\gamma_{Ms,V}$	[-]	1,33								
<p>1) Values are only valid for the given stress area A_s. Values in brackets are valid for undersized threaded rods with smaller stress area A_s for hot-dip galvanised threaded rods according to EN ISO 10684:2004+AC:2009.</p> <p>2) in absence of national regulation</p> <p>3) Fastener type not part of the ETA</p>											
Chemofast Injection system EP 1000 for concrete									Annex C 1		
Performances Characteristic values for steel tension resistance and steel shear resistance of threaded rods											

Table C2: Characteristic values of tension loads under static and quasi-static action for a working life of 50 and 100 years				
Fastener			All Fastener type and sizes	
Concrete cone failure				
Uncracked concrete	$k_{ucr,N}$	[-]	11,0	
Cracked concrete	$k_{cr,N}$	[-]	7,7	
Edge distance	$c_{cr,N}$	[mm]	$1,5 h_{ef}$	
Axial distance	$s_{cr,N}$	[mm]	$2 c_{cr,N}$	
Splitting				
Edge distance	$h/h_{ef} \geq 2,0$	$c_{cr,sp}$	[mm]	$1,0 h_{ef}$
	$2,0 > h/h_{ef} > 1,3$			$2 \cdot h_{ef} \left(2,5 - \frac{h}{h_{ef}} \right)$
	$h/h_{ef} \leq 1,3$			$2,4 h_{ef}$
Axial distance	$s_{cr,sp}$	[mm]	$2 c_{cr,sp}$	
Chemofast Injection system EP 1000 for concrete				Annex C 2
Performances Characteristic values of tension loads under static and quasi-static action for a working life of 50 and 100 years				

Table C3: Characteristic values of tension loads under static and quasi-static action for a working life of 50 years												
Threaded rod					M8	M10	M12	M16	M20	M24	M27	M30
Steel failure												
Characteristic tension resistance		$N_{Rk,s}$	[kN]	$A_s \cdot f_{uk}$ (or see Table C1)								
Partial factor		$\gamma_{Ms,N}$	[-]	see Table C1								
Combined pull-out and concrete failure												
Characteristic bond resistance in uncracked concrete C20/25 in hammer drilled (HD) and compressed air drilled holes (CD)												
Temperature range	I: 24°C/40°C	Dry, wet concrete or flooded bore hole	$\tau_{Rk,ucr}$	[N/mm ²]	20	20	19	19	18	17	16	16
	II: 50°C/72°C				15	15	15	14	13	13	12	12
	III: 60°C/80°C				6,5	6,5	6,5	6,0	6,0	5,5	5,5	5,5
Characteristic bond resistance in uncracked concrete C20/25 in hammer drilled holes with hollow drill bit (HDB)												
Temperature range	I: 24°C/40°C	Dry or wet concrete	$\tau_{Rk,ucr}$	[N/mm ²]	17	16	16	16	15	14	14	13
	II: 50°C/72°C				14	14	14	13	13	12	12	11
	III: 60°C/80°C				6,5	6,5	6,5	6,0	6,0	5,5	5,5	5,5
	I: 24°C/40°C	flooded bore hole			16	16	16	15	15	14	14	13
	II: 50°C/72°C				14	14	14	13	13	12	12	11
	III: 60°C/80°C				6,5	6,5	6,5	6,0	6,0	5,5	5,5	5,5
Characteristic bond resistance in cracked concrete C20/25 in hammer drilled holes (HD) , compressed air drilled holes (CD) and in hammer drilled holes with hollow drill bit (HDB)												
Temperature range	I: 24°C/40°C	Dry, wet concrete or flooded bore hole	$\tau_{Rk,cr}$	[N/mm ²]	7,0	7,0	8,5	8,5	8,5	8,5	8,5	8,5
	II: 50°C/72°C				6,0	6,0	7,0	7,0	7,0	7,0	7,0	7,0
	III: 60°C/80°C				5,0	5,0	5,0	4,5	4,5	4,5	4,5	4,5
Reduction factor in cracked and uncracked concrete C20/25 in hammer drilled holes (HD), compressed air drilled holes (CD) and in hammer drilled holes with hollow drill bit (HDB)												
Temperature range	I: 24°C/40°C	Dry, wet concrete or flooded bore hole	ψ_{sus}^0	[-]	0,99							
	II: 50°C/72°C				0,68							
	III: 60°C/80°C				0,70							
Increasing factors for concrete	≤ C50/60	ψ_c	[-]	$(f_{ck} / 20)^{0,1}$								
	> C50/60			1,1								
Characteristic bond resistance depending on the concrete strength class		$\tau_{Rk,ucr} =$		$\psi_c \cdot \tau_{Rk,ucr,(C20/25)}$								
		$\tau_{Rk,cr} =$		$\psi_c \cdot \tau_{Rk,cr,(C20/25)}$								
Concrete cone failure or Splitting												
Relevant parameter					see Table C2							
Installation factor												
for dry and wet concrete (HD; HDB, CD)		γ_{inst}	[-]	1,0								
for flooded bore hole (HD; HDB, CD)				1,2								
Chemofast Injection system EP 1000 for concrete										Annex C 3		
Performances Characteristic values of tension loads under static and quasi-static action for a working life of 50 years (threaded rod)												

Table C4: Characteristic values of tension loads under static and quasi-static action for a working life of 100 years												
Threaded rod				M8	M10	M12	M16	M20	M24	M27	M30	
Steel failure												
Characteristic tension resistance		$N_{Rk,s}$	[kN]	$A_s \cdot f_{uk}$ (or see Table C1)								
Partial factor		$\gamma_{Ms,N}$	[-]	see Table C1								
Combined pull-out and concrete failure												
Characteristic bond resistance in uncracked concrete C20/25 in hammer drilled (HD) and compressed air drilled holes (CD)												
Temperature range	I: 24°C/40°C	Dry, wet concrete or flooded bore hole	$\tau_{Rk,ucr,100}$	[N/mm ²]	20	20	19	19	18	17	16	16
	II: 50°C/72°C				15	15	15	14	13	13	12	12
	III: 60°C/80°C				6,5	6,5	6,5	6,0	6,0	5,5	5,5	5,5
Characteristic bond resistance in uncracked concrete C20/25 in hammer drilled holes with hollow drill bit (HDB)												
Temperature range	I: 24°C/40°C	Dry or wet concrete	$\tau_{Rk,ucr,100}$	[N/mm ²]	17	16	16	16	15	14	14	13
	II: 50°C/72°C				14	14	14	13	13	12	12	11
	III: 60°C/80°C				6,5	6,5	6,5	6,0	6,0	5,5	5,5	5,5
	I: 24°C/40°C	flooded bore hole			16	16	16	15	15	14	14	13
	II: 50°C/72°C				14	14	14	13	13	12	12	11
	III: 60°C/80°C				6,5	6,5	6,5	6,0	6,0	5,5	5,5	5,5
Characteristic bond resistance in cracked concrete C20/25 in hammer drilled holes (HD) , compressed air drilled holes (CD) and in hammer drilled holes with hollow drill bit (HDB)												
Temperature range	I: 24°C/40°C	Dry, wet concrete or flooded bore hole	$\tau_{Rk,cr,100}$	[N/mm ²]	6,5	6,5	7,5	7,5	7,5	7,5	7,5	7,5
	II: 50°C/72°C				5,5	5,5	6,5	6,5	6,5	6,5	6,5	6,5
	III: 60°C/80°C				5,0	5,0	5,0	4,5	4,5	4,5	4,5	4,5
Reduction factor in cracked and uncracked concrete C20/25 in hammer drilled holes (HD), compressed air drilled holes (CD) and in hammer drilled holes with hollow drill bit (HDB)												
Temperature range	I: 24°C/40°C	Dry, wet concrete or flooded bore hole	$\psi_{sus,100}^0$	[-]	0,97							
	II: 50°C/72°C				0,68							
	III: 60°C/80°C				0,70							
Increasing factors for concrete	\leq C50/60	ψ_c	[-]	$(f_{ck} / 20)^{0,1}$								
	$>$ C50/60			1,1								
Characteristic bond resistance depending on the concrete strength class		$\tau_{Rk,ucr,100} =$		$\psi_c \cdot \tau_{Rk,ucr,100,(C20/25)}$								
		$\tau_{Rk,cr,100} =$		$\psi_c \cdot \tau_{Rk,cr,100,(C20/25)}$								
Concrete cone failure or Splitting												
Relevant parameter				see Table C2								
Installation factor												
for dry and wet concrete (HD; HDB, CD)		γ_{inst}	[-]	1,0								
for flooded bore hole (HD; HDB, CD)				1,2								
Chemofast Injection system EP 1000 for concrete										Annex C 4		
Performances Characteristic values of tension loads under static and quasi-static action for a working life of 100 years (threaded rod)												

Table C5: Characteristic values of tension loads under static and quasi-static action for a working life of 50 years												
Threaded rod					M8	M10	M12	M16	M20	M24	M27	M30
Steel failure												
Characteristic tension resistance		$N_{Rk,s}$	[kN]	$A_s \cdot f_{uk}$ (or see Table C1)								
Partial factor		$\gamma_{Ms,N}$	[-]	see Table C1								
Combined pull-out and concrete failure												
Characteristic bond resistance in uncracked concrete C20/25 in diamond drilled holes (DD)												
Temperature range	I: 24°C/40°C	Dry, wet concrete or flooded bore hole	$\tau_{Rk,ucr}$	[N/mm ²]	15	14	14	13	12	12	11	11
	II: 50°C/72°C				12	12	11	10	9,5	9,5	9,0	9,0
	III: 60°C/80°C				5,5	5,5	5,0	4,5	4,5	4,5	4,0	4,0
Characteristic bond resistance in cracked concrete C20/25 in diamond drilled holes (DD)												
Temperature range	I: 24°C/40°C	Dry, wet concrete or flooded bore hole	$\tau_{Rk,cr}$	[N/mm ²]	1)			5,5	5,5	5,5	5,5	5,4
	II: 50°C/72°C							4,6	4,6	4,6	4,6	4,5
	III: 60°C/80°C							2,4	2,3	2,4	2,4	2,3
Reduction factor in uncracked concrete C20/25 in diamond drilled holes (DD)												
Temperature range	I: 24°C/40°C	Dry, wet concrete or flooded bore hole	ψ_{sus}^0	[-]	0,77							
	II: 50°C/72°C				0,72							
	III: 60°C/80°C				0,72							
Increasing factors for concrete	≤ C50/60	$\psi_{c,ucr}$	[-]	$(f_{ck} / 20)^{0,2}$								
	> C50/60			1,2								
	≤ C50/60	$\psi_{c,cr}$	[-]	$(f_{ck} / 20)^{0,4}$								
Characteristic bond resistance depending on the concrete strength class		$\tau_{Rk,ucr} =$	$\psi_{c,ucr} \cdot \tau_{Rk,ucr,(C20/25)}$									
		$\tau_{Rk,cr} =$	$\psi_{c,cr} \cdot \tau_{Rk,cr,(C20/25)}$									
Concrete cone failure or Splitting												
Relevant parameter					see Table C2							
Installation factor												
for dry and wet concrete (DD)		γ_{inst}	[-]	1,0								
for flooded bore hole (DD)				1,2			1,4					
1) no performance assessed												
Chemofast Injection system EP 1000 for concrete										Annex C 5		
Performances Characteristic values of tension loads under static and quasi-static action for a working life of 50 years (threaded rod)												

Table C6: Characteristic values of tension loads under static and quasi-static action for a working life of 100 years												
Threaded rod				M8	M10	M12	M16	M20	M24	M27	M30	
Steel failure												
Characteristic tension resistance		$N_{Rk,s}$	[kN]	$A_s \cdot f_{uk}$ (or see Table C1)								
Partial factor		$\gamma_{Ms,N}$	[-]	see Table C1								
Combined pull-out and concrete failure												
Characteristic bond resistance in uncracked concrete C20/25 in diamond drilled holes (DD)												
Temperature range	I: 24°C/40°C	Dry, wet concrete or flooded bore hole	$\tau_{Rk,ucr,100}$	[N/mm ²]	15	14	14	13	12	12	11	11
	II: 50°C/72°C				11	11	10	10	9,5	9,0	8,5	8,5
	III: 60°C/80°C				5,5	5,5	5,0	4,5	4,5	4,5	4,0	4,0
Reduction factor in uncracked concrete C20/25 in diamond drilled holes (DD)												
Temperature range	I: 24°C/40°C	Dry, wet concrete or flooded bore hole	$\psi_{sus,100}^0$	[-]	0,73							
	II: 50°C/72°C				0,70							
	III: 60°C/80°C				0,72							
Increasing factors for concrete	≤ C50/60	ψ_c	[-]	$(f_{ck} / 20)^{0,2}$								
	> C50/60			1,2								
Characteristic bond resistance depending on the concrete strength class		$\tau_{Rk,ucr,100} =$		$\psi_c \cdot \tau_{Rk,ucr,100,(C20/25)}$								
Concrete cone failure or Splitting												
Relevant parameter				see Table C2								
Installation factor												
for dry and wet concrete (DD)		γ_{inst}	[-]	1,0								
for flooded bore hole (DD)				1,2				1,4				
Chemofast Injection system EP 1000 for concrete										Annex C 6		
Performances Characteristic values of tension loads under static and quasi-static action for a working life of 100 years (threaded rod)												

Table C8: Characteristic values of tension loads under static and quasi-static action for a working life of 50 years										
Internal threaded anchor rods				IG-M6	IG-M8	IG-M10	IG-M12	IG-M16	IG-M20	
Steel failure¹⁾										
Characteristic tension resistance, Steel, strength class	5.8	$N_{Rk,s}$	[kN]	10	17	29	42	76	123	
	8.8	$N_{Rk,s}$	[kN]	16	27	46	67	121	196	
Partial factor, strength class 5.8 and 8.8	$\gamma_{Ms,N}$			1,5						
Characteristic tension resistance, Stainless Steel A4 and HCR, Strength class 70 ²⁾		$N_{Rk,s}$	[kN]	14	26	41	59	110	124	
Partial factor	$\gamma_{Ms,N}$			1,87						
Combined pull-out and concrete cone failure										
Characteristic bond resistance in uncracked concrete C20/25 in hammer drilled (HD) and compressed air drilled holes (CD)										
Temperature range	I: 24°C/40°C	Dry, wet concrete or flooded bore hole	$\tau_{Rk,ucr}$	[N/mm ²]	20	19	19	18	17	16
	II: 50°C/72°C				15	15	14	13	13	12
	III: 60°C/80°C				6,5	6,5	6,0	6,0	5,5	5,5
Characteristic bond resistance in uncracked concrete C20/25 in hammer drilled holes with hollow drill bit (HDB)										
Temperature range	I: 24°C/40°C	Dry or wet concrete	$\tau_{Rk,ucr}$	[N/mm ²]	16	16	16	15	14	13
	II: 50°C/72°C				14	14	13	13	12	11
	III: 60°C/80°C				6,5	6,5	6,0	6,0	5,5	5,5
	I: 24°C/40°C	flooded bore hole			16	16	15	15	14	13
	II: 50°C/72°C				14	14	13	13	12	11
	III: 60°C/80°C				6,5	6,5	6,0	6,0	5,5	5,5
Characteristic bond resistance in cracked concrete C20/25 in hammer drilled holes (HD), compressed air drilled holes (CD) and in hammer drilled holes with hollow drill bit (HDB)										
Temperature range	I: 24°C/40°C	Dry, wet concrete or flooded bore hole	$\tau_{Rk,cr}$	[N/mm ²]	7,0	8,5	8,5	8,5	8,5	8,5
	II: 50°C/72°C				6,0	7,0	7,0	7,0	7,0	7,0
	III: 60°C/80°C				5,0	5,0	4,5	4,5	4,5	4,5
Reduction factor in cracked and uncracked concrete C20/25 in hammer drilled holes (HD), compressed air drilled holes (CD) and in hammer drilled holes with hollow drill bit (HDB)										
Temperature range	I: 24°C/40°C	Dry, wet concrete or flooded bore hole	ψ_{sus}^0	[-]	0,99					
	II: 50°C/72°C				0,68					
	III: 60°C/80°C				0,70					
Increasing factors for concrete	$\leq C50/60$		ψ_c	[-]	$(f_{ck} / 20)^{0,1}$					
	$> C50/60$				1,1					
Characteristic bond resistance depending on the concrete strength class			$\tau_{Rk,ucr} =$		$\psi_c \cdot \tau_{Rk,ucr,(C20/25)}$					
			$\tau_{Rk,cr} =$		$\psi_c \cdot \tau_{Rk,cr,(C20/25)}$					
Concrete cone failure or Splitting										
Relevant parameter				see Table C2						
Installation factor										
for dry and wet concrete (HD; HDB, CD)				γ_{inst}	[-]	1,0				
for flooded bore hole (HD; HDB, CD)						1,2				
¹⁾ Fastenings (incl. nut and washer) must comply with the appropriate material and property class of the internal threaded rod. The characteristic tension resistance for steel failure is valid for the internal threaded rod and the fastening element. ²⁾ For IG-M20 strength class 50 is valid										
Chemofast Injection system EP 1000 for concrete								Annex C 8		
Performances Characteristic values of tension loads under static and quasi-static action for a working life of 50 years (Internal threaded anchor rod)										

Table C9: Characteristic values of tension loads under static and quasi-static action for a working life of 100 years										
Internal threaded anchor rods				IG-M6	IG-M8	IG-M10	IG-M12	IG-M16	IG-M20	
Steel failure¹⁾										
Characteristic tension resistance, Steel, strength class	5.8 8.8	$N_{Rk,s}$	[kN]	10 16	17 27	29 46	42 67	76 121	123 196	
Partial factor, strength class 5.8 and 8.8	$\gamma_{Ms,N}$			1,5						
Characteristic tension resistance, Stainless Steel A4 and HCR, Strength class 70 ²⁾		$N_{Rk,s}$	[kN]	14	26	41	59	110	124	
Partial factor	$\gamma_{Ms,N}$			1,87						
Combined pull-out and concrete cone failure										
Characteristic bond resistance in uncracked concrete C20/25 in hammer drilled (HD) and compressed air drilled holes (CD)										
Temperature range	I: 24°C/40°C	Dry, wet concrete or flooded bore hole	$\tau_{Rk,ucr,100}$	[N/mm ²]	20	19	19	18	17	16
	II: 50°C/72°C				15	15	14	13	13	12
	III: 60°C/80°C				6,5	6,5	6,0	6,0	5,5	5,5
Characteristic bond resistance in uncracked concrete C20/25 in hammer drilled holes with hollow drill bit (HDB)										
Temperature range	I: 24°C/40°C	Dry or wet concrete	$\tau_{Rk,ucr,100}$	[N/mm ²]	16	16	16	15	14	13
	II: 50°C/72°C				14	14	13	13	12	11
	III: 60°C/80°C				6,5	6,5	6,0	6,0	5,5	5,5
	I: 24°C/40°C	flooded bore hole			16	16	15	15	14	13
	II: 50°C/72°C				14	14	13	13	12	11
	III: 60°C/80°C				6,5	6,5	6,0	6,0	5,5	5,5
Characteristic bond resistance in cracked concrete C20/25 in hammer drilled holes (HD), compressed air drilled holes (CD) and in hammer drilled holes with hollow drill bit (HDB)										
Temperature range	I: 24°C/40°C	Dry, wet concrete or flooded bore hole	$\tau_{Rk,cr,100}$	[N/mm ²]	6,5	7,5	7,5	7,5	7,5	7,5
	II: 50°C/72°C				5,5	6,5	6,5	6,5	6,5	6,5
	III: 60°C/80°C				5,0	5,0	4,5	4,5	4,5	4,5
Reduction factor in cracked and uncracked concrete C20/25 in hammer drilled holes (HD), compressed air drilled holes (CD) and in hammer drilled holes with hollow drill bit (HDB)										
Temperature range	I: 24°C/40°C	Dry, wet concrete or flooded bore hole	$\psi_{sus,100}^0$	[-]	0,97					
	II: 50°C/72°C				0,68					
	III: 60°C/80°C				0,70					
Increasing factors for concrete	$\leq C50/60$ $> C50/60$	ψ_c	[-]	$(f_{ck} / 20)^{0,1}$ 1,1						
Characteristic bond resistance depending on the concrete strength class			$\tau_{Rk,ucr,100} =$	$\psi_c \cdot \tau_{Rk,ucr,100,(C20/25)}$						
			$\tau_{Rk,cr,100} =$	$\psi_c \cdot \tau_{Rk,cr,100,(C20/25)}$						
Concrete cone failure or Splitting										
Relevant parameter				see Table C2						
Installation factor										
for dry and wet concrete (HD; HDB, CD)				γ_{inst}	[-]	1,0				
for flooded bore hole (HD; HDB, CD)				1,2						
¹⁾ Fastenings (incl. nut and washer) must comply with the appropriate material and property class of the internal threaded rod. The characteristic tension resistance for steel failure is valid for the internal threaded rod and the fastening element. ²⁾ For IG-M20 strength class 50 is valid										
Chemofast Injection system EP 1000 for concrete								Annex C 9		
Performances Characteristic values of tension loads under static and quasi-static action for a working life of 100 years (Internal threaded anchor rod)										

Table C10: Characteristic values of tension loads under static and quasi-static action for a working life of 50 years										
Internal threaded anchor rods				IG-M6	IG-M8	IG-M10	IG-M12	IG-M16	IG-M20	
Steel failure¹⁾										
Characteristic tension resistance, Steel, strength class	5.8	$N_{Rk,s}$	[kN]	10	17	29	42	76	123	
	8.8	$N_{Rk,s}$	[kN]	16	27	46	67	121	196	
Partial factor, strength class 5.8 and 8.8	$\gamma_{Ms,N}$		[-]	1,5						
Characteristic tension resistance, Stainless Steel A4 and HCR, Strength class 70 ²⁾		$N_{Rk,s}$	[kN]	14	26	41	59	110	124	
Partial factor	$\gamma_{Ms,N}$		[-]	1,87					2,86	
Combined pull-out and concrete cone failure										
Characteristic bond resistance in uncracked concrete C20/25 in diamond drilled holes (DD)										
Temperature range	I: 24°C/40°C	Dry, wet concrete or flooded bore hole	$\tau_{Rk,ucr}$	[N/mm ²]	14	14	13	12	12	11
	II: 50°C/72°C				12	11	10	9,5	9,5	9,0
	III: 60°C/80°C				5,5	5,0	4,5	4,5	4,5	4,0
Characteristic bond resistance in cracked concrete C20/25 in diamond drilled holes (DD)										
Temperature range	I: 24°C/40°C	Dry, wet concrete or flooded bore hole	$\tau_{Rk,cr}$	[N/mm ²]	3)	5,5	5,5	5,5	5,4	
	II: 50°C/72°C					4,6	4,6	4,6	4,5	
	III: 60°C/80°C					2,4	2,3	2,4	2,3	
Reduction factor in uncracked concrete C20/25 in diamond drilled holes (DD)										
Temperature range	I: 24°C/40°C	Dry, wet concrete or flooded bore hole	ψ_{sus}^0	[-]	0,77					
	II: 50°C/72°C				0,72					
	III: 60°C/80°C				0,72					
Increasing factors for concrete	\leq C50/60	$\psi_{c,ucr}$	[-]	$(f_{ck} / 20)^{0,2}$						
	$>$ C50/60			1,2						
	\leq C50/60	$\psi_{c,cr}$	[-]	$(f_{ck} / 20)^{0,4}$						
Characteristic bond resistance depending on the concrete strength class			$\tau_{Rk,ucr} =$		$\psi_{c,ucr} \cdot \tau_{Rk,ucr,(C20/25)}$					
			$\tau_{Rk,cr} =$		$\psi_{c,cr} \cdot \tau_{Rk,cr,(C20/25)}$					
Concrete cone failure or Splitting										
Relevant parameter				see Table C2						
Installation factor										
for dry and wet concrete (DD)				γ_{inst}	[-]	1,0				
for flooded bore hole (DD)						1,2	1,4			
¹⁾ Fastenings (incl. nut and washer) must comply with the appropriate material and property class of the internal threaded rod. The characteristic tension resistance for steel failure is valid for the internal threaded rod and the fastening element. ²⁾ For IG-M20 strength class 50 is valid ³⁾ no performance assessed										
Chemofast Injection system EP 1000 for concrete								Annex C 10		
Performances Characteristic values of tension loads under static and quasi-static action for a working life of 50 years (Internal threaded anchor rod)										

Table C11: Characteristic values of tension loads under static and quasi-static action for a working life of 100 years										
Internal threaded anchor rods				IG-M6	IG-M8	IG-M10	IG-M12	IG-M16	IG-M20	
Steel failure¹⁾										
Characteristic tension resistance, Steel, strength class	5.8	$N_{Rk,s}$	[kN]	10	17	29	42	76	123	
	8.8	$N_{Rk,s}$	[kN]	16	27	46	67	121	196	
Partial factor, strength class 5.8 and 8.8		$\gamma_{Ms,N}$	[-]	1,5						
Characteristic tension resistance, Stainless Steel A4 and HCR, Strength class 70 ²⁾		$N_{Rk,s}$	[kN]	14	26	41	59	110	124	
Partial factor		$\gamma_{Ms,N}$	[-]	1,87						
Combined pull-out and concrete cone failure										
Characteristic bond resistance in uncracked concrete C20/25 in diamond drilled holes (DD)										
Temperature range	I: 24°C/40°C	Dry, wet concrete or flooded bore hole	$\tau_{Rk,ucr,100}$	[N/mm ²]	14	14	13	12	12	11
	II: 50°C/72°C				11	10	10	9,5	9,0	8,5
	III: 60°C/80°C				5,5	5,0	4,5	4,5	4,5	4,0
Reduction factor in uncracked concrete C20/25 in diamond drilled holes (DD)										
Temperature range	I: 24°C/40°C	Dry, wet concrete or flooded bore hole	$\psi_{sus,100}^0$	[-]	0,73					
	II: 50°C/72°C				0,70					
	III: 60°C/80°C				0,72					
Increasing factors for concrete		≤ C50/60	ψ_c	[-]	$(f_{ck} / 20)^{0,2}$					
		> C50/60			1,2					
Characteristic bond resistance depending on the concrete strength class			$\tau_{Rk,ucr,100} =$		$\psi_c \cdot \tau_{Rk,ucr,100,(C20/25)}$					
Concrete cone failure or Splitting										
Relevant parameter				see Table C2						
Installation factor										
for dry and wet concrete (DD)		γ_{inst}	[-]	1,0						
for flooded bore hole (DD)				1,2			1,4			
<p>1) Fastenings (incl. nut and washer) must comply with the appropriate material and property class of the internal threaded rod. The characteristic tension resistance for steel failure is valid for the internal threaded rod and the fastening element.</p> <p>2) For IG-M20 strength class 50 is valid</p>										
Chemofast Injection system EP 1000 for concrete								Annex C 11		
Performances Characteristic values of tension loads under static and quasi-static action for a working life of 100 years (Internal threaded anchor rod)										

Table C12: Characteristic values of shear loads under static and quasi-static action for a working life of 50 and 100 years									
Internal threaded anchor rods				IG-M6	IG-M8	IG-M10	IG-M12	IG-M16	IG-M20
Steel failure without lever arm¹⁾									
Characteristic shear resistance, Steel, strength class	5.8	$V_{Rk,s}^0$	[kN]	5	9	15	21	38	61
	8.8	$V_{Rk,s}^0$	[kN]	8	14	23	34	60	98
Partial factor, strength class 5.8 and 8.8	$\gamma_{Ms,V}$		[-]	1,25					
Characteristic shear resistance, Stainless Steel A4 and HCR, Strength class 70 ²⁾		$V_{Rk,s}^0$	[kN]	7	13	20	30	55	40
		$\gamma_{Ms,V}$	[-]	1,56					2,38
Ductility factor	k_7		[-]	1,0					
Steel failure with lever arm¹⁾									
Characteristic bending moment, Steel, strength class	5.8	$M_{Rk,s}^0$	[Nm]	8	19	37	66	167	325
	8.8	$M_{Rk,s}^0$	[Nm]	12	30	60	105	267	519
Partial factor, strength class 5.8 and 8.8	$\gamma_{Ms,V}$		[-]	1,25					
Characteristic bending moment, Stainless Steel A4 and HCR, Strength class 70 ²⁾		$M_{Rk,s}^0$	[Nm]	11	26	52	92	233	456
		$\gamma_{Ms,V}$	[-]	1,56					2,38
Concrete pry-out failure									
Factor	k_8		[-]	2,0					
Installation factor	γ_{inst}		[-]	1,0					
Concrete edge failure									
Effective length of fastener	l_f	[mm]	$\min(h_{ef}; 12 \cdot d_{nom})$						$\min(h_{ef}; 300\text{mm})$
Outside diameter of fastener	d_{nom}	[mm]	10	12	16	20	24	30	
Installation factor	γ_{inst}		[-]	1,0					
<p>¹⁾ Fastenings (incl. nut and washer) must comply with the appropriate material and property class of the internal threaded rod. The characteristic tension resistance for steel failure is valid for the internal threaded rod and the fastening element.</p> <p>²⁾ For IG-M20 strength class 50 is valid</p>									
Chemofast Injection system EP 1000 for concrete								Annex C 12	
Performances Characteristic values of shear loads under static and quasi-static action for a working life of 50 and 100 years (Internal threaded anchor rod)									

Table C13: Characteristic values of tension loads under static and quasi-static action for a working life of 50 years																
Reinforcing bar			Ø 8	Ø 10	Ø 12	Ø 14	Ø 16	Ø 20	Ø 24	Ø 25	Ø 28	Ø 32	Ø 36	Ø 40		
Steel failure																
Characteristic tension resistance	$N_{Rk,s}$	[kN]	$A_s \cdot f_{uk}^{1)}$													
Cross section area	A_s	[mm ²]	50	79	113	154	201	314	452	491	616	804	1018	1256		
Partial factor	$\gamma_{Ms,N}$	[-]	1,4 ²⁾													
Combined pull-out and concrete failure																
Characteristic bond resistance in uncracked concrete C20/25 in hammer (HD) and compressed air drilled holes (CD)																
Temp.-range	I: 24°C/40°C	Dry, wet concrete or flooded bore hole	$\tau_{Rk,ucr}$	[N/mm ²]	16	16	16	16	16	16	15	15	15	15	15	
	II: 50°C/72°C				12	12	12	12	12	12	12	12	11	11	11	11
	III: 60°C/80°C				5,5	5,5	5,5	5,5	5,5	5,5	5,0	5,0	5,0	5,0	4,5	4,5
Characteristic bond resistance in uncracked concrete C20/25 in hammer drilled holes with hollow drill bit (HDB)																
Temperature range	I: 24°C/40°C	Dry, wet concrete	$\tau_{Rk,ucr}$	[N/mm ²]	14	14	13	13	13	13	13	13	13	13	3)	
	II: 50°C/72°C				12	12	12	11	11	11	11	11	11	11		
	III: 60°C/80°C				5,5	5,5	5,5	5,5	5,5	5,5	5,0	5,0	5,0	5,0		
	I: 24°C/40°C	flooded bore hole			13	13	13	13	13	13	13	13	13	13		
	II: 50°C/72°C				11	11	11	11	11	11	11	11	11	11		
	III: 60°C/80°C				5,5	5,5	5,5	5,5	5,5	5,5	5,0	5,0	5,0	5,0		
Characteristic bond resistance in cracked concrete C20/25 in hammer drilled holes (HD), compressed air drilled holes (CD) and in hammer drilled holes with hollow drill bit (HDB)																
Temp.-range	I: 24°C/40°C	Dry, wet concrete or flooded bore hole	$\tau_{Rk,cr}$	[N/mm ²]	7,0	7,0	8,5	8,5	8,5	8,5	8,5	8,5	8,5	8,5	3)	
	II: 50°C/72°C				6,0	6,0	7,0	7,0	7,0	7,0	7,0	7,0	7,0	7,0		
	III: 60°C/80°C				4,5	4,5	4,5	4,5	4,5	4,5	4,5	4,5	4,5	4,5		
Reduction factor in cracked and uncracked concrete C20/25 in hammer drilled holes (HD), compressed air drilled holes (CD) and in hammer drilled holes with hollow drill bit (HDB)																
Temp.-range	I: 24°C/40°C	Dry, wet and flooded bore hole	ψ_{sus}^0	[-]	0,99											
	II: 50°C/72°C				0,68											
	III: 60°C/80°C				0,70											
Increasing factors for concrete	≤ C50/60	ψ_c	[-]	$(f_{ck} / 20)^{0,1}$												
	> C50/60			1,1												
Characteristic bond resistance depending on the concrete strength class	$\tau_{Rk,ucr} =$		$\psi_c \cdot \tau_{Rk,ucr,(C20/25)}$													
	$\tau_{Rk,cr} =$		$\psi_c \cdot \tau_{Rk,cr,(C20/25)}$													
Concrete cone failure or Splitting																
Relevant parameter			see Table C2													
Installation factor (HD; HDB, CD)																
for dry and wet concrete	γ_{inst}	[-]	1,0										1,2			
for flooded bore hole			1,2										3)			
¹⁾ f_{uk} shall be taken from the specifications of reinforcing bars ²⁾ in absence of national regulation ³⁾ no performance assessed																
Chemofast Injection system EP 1000 for concrete												Annex C 13				
Performances Characteristic values of tension loads under static and quasi-static action for a working life of 50 years (reinforcing bar)																

Table C14: Characteristic values of tension loads under static and quasi-static action for a working life of 100 years															
Reinforcing bar			Ø 8	Ø 10	Ø 12	Ø 14	Ø 16	Ø 20	Ø 24	Ø 25	Ø 28	Ø 32	Ø 36	Ø 40	
Steel failure															
Characteristic tension resistance	$N_{Rk,s}$	[kN]	$A_s \cdot f_{uk}^{1)}$												
Cross section area	A_s	[mm ²]	50	79	113	154	201	314	452	491	616	804	1018	1256	
Partial factor	$\gamma_{Ms,N}$	[-]	1,4 ²⁾												
Combined pull-out and concrete failure															
Characteristic bond resistance in uncracked concrete C20/25 in hammer (HD) and compressed air drilled holes (CD)															
Temp.-range I: 24°C/40°C II: 50°C/72°C III: 60°C/80°C	Dry, wet concrete or flooded bore hole	$\tau_{Rk,ucr,100}$	[N/mm ²]	16	16	16	16	16	16	15	15	15	15	15	15
				12	12	12	12	12	12	12	12	11	11	11	11
				5,5	5,5	5,5	5,5	5,5	5,5	5,0	5,0	5,0	5,0	4,5	4,5
Characteristic bond resistance in uncracked concrete C20/25 in hammer drilled holes with hollow drill bit (HDB)															
Temperature range I: 24°C/40°C II: 50°C/72°C III: 60°C/80°C	Dry or wet concrete	$\tau_{Rk,ucr,100}$	[N/mm ²]	14	14	13	13	13	13	13	13	13	13	13	3)
				12	12	12	11	11	11	11	11	11	11		
				5,5	5,5	5,5	5,5	5,5	5,5	5,0	5,0	5,0	5,0		
	flooded bore hole			13	13	13	13	13	13	13	13	13	13		
				11	11	11	11	11	11	11	11	11	11		
				5,5	5,5	5,5	5,5	5,5	5,5	5,0	5,0	5,0	5,0		
Characteristic bond resistance in cracked concrete C20/25 in hammer drilled holes (HD), compressed air drilled holes (CD) and in hammer drilled holes with hollow drill bit (HDB)															
Temp.-range I: 24°C/40°C II: 50°C/72°C III: 60°C/80°C	Dry, wet concrete or flooded bore hole	$\tau_{Rk,cr,100}$	[N/mm ²]	6,5	6,5	7,5	7,5	7,5	7,5	7,5	7,5	7,5	7,5	7,5	3)
				5,5	5,5	6,5	6,5	6,5	6,5	6,5	6,5	6,5	6,5		
				4,5	4,5	4,5	4,5	4,5	4,5	4,5	4,5	4,5	4,5		
Reduction factor in cracked and uncracked concrete C20/25 in hammer drilled holes (HD), compressed air drilled holes (CD) and in hammer drilled holes with hollow drill bit (HDB)															
Temp.-range I: 24°C/40°C II: 50°C/72°C III: 60°C/80°C	Dry, wet concrete or flooded bore hole	$\psi_{sus,100}^0$	[-]	0,97											
				0,68											
				0,70											
Increasing factors for concrete	≤ C50/60	ψ_c	[-]	$(f_{ck} / 20)^{0,1}$											
	> C50/60			1,1											
Characteristic bond resistance depending on the concrete strength class	$\tau_{Rk,ucr,100} =$		$\psi_c \cdot \tau_{Rk,ucr,100,(C20/25)}$												
	$\tau_{Rk,cr,100} =$		$\psi_c \cdot \tau_{Rk,cr,100,(C20/25)}$												
Concrete cone failure or Splitting															
Relevant parameter			see Table C2												
Installation factor (HD; HDB, CD)															
for dry and wet concrete		γ_{inst}	[-]	1,0											1,2
for flooded bore hole				1,2											3)
<p>1) f_{uk} shall be taken from the specifications of reinforcing bars</p> <p>2) in absence of national regulation</p> <p>3) no performance assessed</p>															
Chemofast Injection system EP 1000 for concrete													Annex C 14		
<p>Performances</p> <p>Characteristic values of tension loads under static and quasi-static action for a working life of 100 years (reinforcing bar)</p>															

Table C15: Characteristic values of tension loads under static and quasi-static action for a working life of 50 years															
Reinforcing bar		Ø 8	Ø 10	Ø 12	Ø 14	Ø 16	Ø 20	Ø 24	Ø 25	Ø 28	Ø 32	Ø 36	Ø 40		
Steel failure															
Characteristic tension resistance	$N_{Rk,s}$	[kN]	$A_s \cdot f_{uk}^{1)}$												
Cross section area	A_s	[mm ²]	50	79	113	154	201	314	452	491	616	804	1018	1256	
Partial factor	$\gamma_{Ms,N}$	[-]	1,4 ²⁾												
Combined pull-out and concrete failure															
Characteristic bond resistance in uncracked concrete C20/25 in diamond drilled holes (DD)															
Temperature range I: 24°C/40°C II: 50°C/72°C III: 60°C/80°C	Dry, wet concrete or flooded bore hole	$\tau_{Rk,ucr}$	[N/mm ²]	14	13	13	13	12	12	11	11	11	11	10	
				11	11	10	10	10	9,5	9,5	9,5	9,0	9,0	8,5	8,5
				5,0	5,0	5,0	4,5	4,5	4,5	4,0	4,0	4,0	4,0	4,0	4,0
Reduction factor in uncracked concrete C20/25 in diamond drilled holes (DD)															
Temperature range I: 24°C/40°C II: 50°C/72°C III: 60°C/80°C	Dry, wet concrete or flooded bore hole	ψ_{sus}^0	[-]	0,77											
				0,72											
				0,72											
Increasing factors for concrete	≤ C50/60	$\psi_{c,ucr}$	[-]	$(f_{ck} / 20)^{0,2}$											
	> C50/60			1,2											
Characteristic bond resistance depending on the concrete strength class		$\tau_{Rk,ucr} =$		$\psi_{c,ucr} \cdot \tau_{Rk,ucr,(C20/25)}$											
Concrete cone failure or Splitting															
Relevant parameter		see Table C2													
Installation factor (DD)															
for dry and wet concrete	γ_{inst}	[-]	1,0										1,2		
for flooded bore hole			1,2					1,4					3)		
¹⁾ f_{uk} shall be taken from the specifications of reinforcing bars ²⁾ in absence of national regulation ³⁾ no performance assessed															
Chemofast Injection system EP 1000 for concrete												Annex C 15			
Performances Characteristic values of tension loads under static and quasi-static action for a working life of 50 years (reinforcing bar)															

Table C16: Characteristic values of tension loads under static and quasi-static action for a working life of 100 years															
Reinforcing bar		Ø 8	Ø 10	Ø 12	Ø 14	Ø 16	Ø 20	Ø 24	Ø 25	Ø 28	Ø 32	Ø 36	Ø 40		
Steel failure															
Characteristic tension resistance	$N_{Rk,s}$	[kN]	$A_s \cdot f_{uk}^{1)}$												
Cross section area	A_s	[mm ²]	50	79	113	154	201	314	452	491	616	804	1018	1256	
Partial factor	$\gamma_{Ms,N}$	[-]	1,4 ²⁾												
Combined pull-out and concrete failure															
Characteristic bond resistance in uncracked concrete C20/25 in diamond drilled holes (DD)															
Temperature range I: 24°C/40°C II: 50°C/72°C III: 60°C/80°C	Dry, wet concrete or flooded bore hole	$\tau_{Rk,ucr,100}$	[N/mm ²]	14	13	13	13	12	12	11	11	11	11	10	
				11	10	10	10	9,5	9,0	9,0	9,0	8,5	8,5	8,0	8,0
				5,0	5,0	5,0	4,5	4,5	4,5	4,0	4,0	4,0	4,0	4,0	4,0
Reduction factor in uncracked concrete C20/25 in diamond drilled holes (DD)															
Temperature range I: 24°C/40°C II: 50°C/72°C III: 60°C/80°C	Dry, wet concrete or flooded bore hole	$\psi_{sus,100}^0$	[-]	0,73											
				0,70											
				0,72											
Increasing factors for concrete	≤ C50/60	$\psi_{c,ucr}$	[-]	$(f_{ck} / 20)^{0,2}$											
	> C50/60			1,2											
Characteristic bond resistance depending on the concrete strength class		$\tau_{Rk,ucr,100} =$		$\psi_{c,ucr} \cdot \tau_{Rk,ucr,100,(C20/25)}$											
Concrete cone failure or Splitting															
Relevant parameter		see Table C2													
Installation factor (DD)															
for dry and wet concrete	γ_{inst}	[-]	1,0										1,2		
for flooded bore hole			1,2					1,4					3)		
¹⁾ f_{uk} shall be taken from the specifications of reinforcing bars ²⁾ in absence of national regulation ³⁾ no performance assessed															
Chemofast Injection system EP 1000 for concrete												Annex C 16			
Performances Characteristic values of tension loads under static and quasi-static action for a working life of 100 years (reinforcing bar)															

Table C17: Characteristic values of shear loads under static and quasi-static action for a working life of 50 and 100 years														
Reinforcing bar			Ø 8	Ø 10	Ø 12	Ø 14	Ø 16	Ø 20	Ø 24	Ø 25	Ø 28	Ø 32	Ø 36	Ø 40
Steel failure without lever arm														
Characteristic shear resistance	$V_{RK,s}^0$	[kN]	$0,5 \cdot A_s \cdot f_{uk}^{1)}$											
Cross section area	A_s	[mm ²]	50	79	113	154	201	314	452	491	616	804	1018	1256
Partial factor	$\gamma_{Ms,V}$	[-]	1,5 ²⁾											
Ductility factor	k_7	[-]	1,0											
Steel failure with lever arm														
Characteristic bending moment	$M_{RK,s}^0$	[Nm]	$1,2 \cdot W_{el} \cdot f_{uk}^{1)}$											
Elastic section modulus	W_{el}	[mm ³]	50	98	170	269	402	785	1357	1534	2155	3217	4580	6283
Partial factor	$\gamma_{Ms,V}$	[-]	1,5 ²⁾											
Concrete pry-out failure														
Factor	k_8	[-]	2,0											
Installation factor	γ_{inst}	[-]	1,0											
Concrete edge failure														
Effective length of fastener	l_f	[mm]	$\min(h_{ef}; 12 \cdot d_{nom})$						$\min(h_{ef}; 300\text{mm})$					
Outside diameter of fastener	d_{nom}	[mm]	8	10	12	14	16	20	24	25	28	32	36	40
Installation factor	γ_{inst}	[-]	1,0											
<p>1) f_{uk} shall be taken from the specifications of reinforcing bars</p> <p>2) in absence of national regulation</p>														
Chemofast Injection system EP 1000 for concrete											Annex C 17			
<p>Performances Characteristic values of shear loads under static and quasi-static action for a working life of 50 and 100 years (reinforcing bar)</p>														

Table C18: Displacements under tension load¹⁾ in hammer drilled holes (HD), comp. air drilled holes (CD) and in hammer drilled holes with hollow drill bit (HDB)										
Threaded rod			M8	M10	M12	M16	M20	M24	M27	M30
Uncracked concrete under static and quasi-static action for a working life of 50 and 100 years										
Temperature range I: 24°C/40°C	δ_{N0} -factor	[mm/(N/mm ²)]	0,028	0,029	0,030	0,033	0,035	0,038	0,039	0,041
	$\delta_{N\infty}$ -factor	[mm/(N/mm ²)]	0,028	0,029	0,030	0,033	0,035	0,038	0,039	0,041
Temperature range II: 50°C/72°C	δ_{N0} -factor	[mm/(N/mm ²)]	0,038	0,039	0,040	0,044	0,047	0,051	0,052	0,055
	$\delta_{N\infty}$ -factor	[mm/(N/mm ²)]	0,047	0,049	0,051	0,055	0,059	0,064	0,067	0,070
Temperature range III: 60°C/80°C	δ_{N0} -factor	[mm/(N/mm ²)]	0,038	0,039	0,040	0,044	0,047	0,051	0,052	0,055
	$\delta_{N\infty}$ -factor	[mm/(N/mm ²)]	0,047	0,049	0,051	0,055	0,059	0,064	0,067	0,070
Cracked concrete under static and quasi-static action for a working life of 50 and 100 years										
Temperature range I: 24°C/40°C	δ_{N0} -factor	[mm/(N/mm ²)]	0,069	0,071	0,072	0,074	0,076	0,079	0,081	0,082
	$\delta_{N\infty}$ -factor	[mm/(N/mm ²)]	0,100	0,115	0,122	0,128	0,135	0,142	0,155	0,171
Temperature range II: 50°C/72°C	δ_{N0} -factor	[mm/(N/mm ²)]	0,092	0,095	0,096	0,099	0,102	0,106	0,109	0,110
	$\delta_{N\infty}$ -factor	[mm/(N/mm ²)]	0,134	0,154	0,163	0,172	0,181	0,189	0,207	0,229
Temperature range III: 60°C/80°C	δ_{N0} -factor	[mm/(N/mm ²)]	0,092	0,095	0,096	0,099	0,102	0,106	0,109	0,110
	$\delta_{N\infty}$ -factor	[mm/(N/mm ²)]	0,134	0,154	0,163	0,172	0,181	0,189	0,207	0,229
1) Calculation of the displacement: $\delta_{N0} = \delta_{N0}\text{-factor} \cdot \tau$; $\delta_{N\infty} = \delta_{N\infty}\text{-factor} \cdot \tau$; τ : action bond stress for tension										
Table C19: Displacements under tension load¹⁾ in diamond drilled holes (DD)										
Threaded rod			M8	M10	M12	M16	M20	M24	M27	M30
Cracked and uncracked concrete under static and quasi-static action for a working life of 50 years										
Temperature range I: 24°C/40°C	δ_{N0} -factor	[mm/(N/mm ²)]	0,011	0,012	0,012	0,013	0,014	0,014	0,015	0,015
	$\delta_{N\infty}$ -factor	[mm/(N/mm ²)]	0,018	0,019	0,019	0,020	0,022	0,023	0,024	0,025
Temperature range II: 50°C/72°C	δ_{N0} -factor	[mm/(N/mm ²)]	0,013	0,014	0,014	0,015	0,016	0,016	0,018	0,018
	$\delta_{N\infty}$ -factor	[mm/(N/mm ²)]	0,052	0,053	0,055	0,058	0,062	0,065	0,068	0,070
Temperature range III: 60°C/80°C	δ_{N0} -factor	[mm/(N/mm ²)]	0,013	0,014	0,014	0,015	0,016	0,016	0,018	0,018
	$\delta_{N\infty}$ -factor	[mm/(N/mm ²)]	0,052	0,053	0,055	0,058	0,062	0,065	0,068	0,070
Uncracked concrete under static and quasi-static action for a working life of 100 years										
Temperature range I: 24°C/40°C	δ_{N0} -factor	[mm/(N/mm ²)]	0,011	0,012	0,012	0,013	0,014	0,014	0,015	0,015
	$\delta_{N\infty}$ -factor	[mm/(N/mm ²)]	0,020	0,021	0,021	0,023	0,024	0,025	0,026	0,027
Temperature range II: 50°C/72°C	δ_{N0} -factor	[mm/(N/mm ²)]	0,013	0,014	0,014	0,015	0,016	0,016	0,018	0,018
	$\delta_{N\infty}$ -factor	[mm/(N/mm ²)]	0,038	0,039	0,040	0,043	0,045	0,047	0,049	0,051
Temperature range III: 60°C/80°C	δ_{N0} -factor	[mm/(N/mm ²)]	0,013	0,014	0,014	0,015	0,016	0,016	0,018	0,018
	$\delta_{N\infty}$ -factor	[mm/(N/mm ²)]	0,038	0,039	0,040	0,043	0,045	0,047	0,049	0,051
1) Calculation of the displacement: $\delta_{N0} = \delta_{N0}\text{-factor} \cdot \tau$; $\delta_{N\infty} = \delta_{N\infty}\text{-factor} \cdot \tau$; τ : action bond stress for tension										
Table C20: Displacements under shear load¹⁾ for all drilling methods										
Threaded rod			M8	M10	M12	M16	M20	M24	M27	M30
Uncracked and cracked concrete under static and quasi-static action for a working life of 50 and 100 years										
All temperature ranges	δ_{V0} -factor	[mm/kN]	0,06	0,06	0,05	0,04	0,04	0,03	0,03	0,03
	$\delta_{V\infty}$ -factor	[mm/kN]	0,09	0,08	0,08	0,06	0,06	0,05	0,05	0,05
1) Calculation of the displacement $\delta_{V0} = \delta_{V0}\text{-factor} \cdot V$; $\delta_{V\infty} = \delta_{V\infty}\text{-factor} \cdot V$; V : action shear load										
Chemofast Injection system EP 1000 for concrete									Annex C 18	
Performances Displacements under static and quasi-static action for a working life of 50 and 100 years (threaded rod)										

Table C21: Displacements under tension load¹⁾ in hammer drilled holes (HD), comp. air drilled holes (CD) and in hammer drilled holes with hollow drill bit (HDB)

Internal threaded anchor rods			IG-M6	IG-M8	IG-M10	IG-M12	IG-M16	IG-M20
Uncracked concrete under static and quasi-static action for a working life of 50 and 100 years								
Temperature range I: 24°C/40°C	δ_{N0} -factor	[mm/(N/mm ²)]	0,029	0,030	0,033	0,035	0,038	0,041
	$\delta_{N\infty}$ -factor	[mm/(N/mm ²)]	0,029	0,030	0,033	0,035	0,038	0,041
Temperature range II: 50°C/72°C	δ_{N0} -factor	[mm/(N/mm ²)]	0,039	0,040	0,044	0,047	0,051	0,055
	$\delta_{N\infty}$ -factor	[mm/(N/mm ²)]	0,049	0,051	0,055	0,059	0,064	0,070
Temperature range III: 60°C/80°C	δ_{N0} -factor	[mm/(N/mm ²)]	0,039	0,040	0,044	0,047	0,051	0,055
	$\delta_{N\infty}$ -factor	[mm/(N/mm ²)]	0,049	0,051	0,055	0,059	0,064	0,070
Cracked concrete under static and quasi-static action for a working life of 50 and 100 years								
Temperature range I: 24°C/40°C	δ_{N0} -factor	[mm/(N/mm ²)]	0,071	0,072	0,074	0,076	0,079	0,082
	$\delta_{N\infty}$ -factor	[mm/(N/mm ²)]	0,115	0,122	0,128	0,135	0,142	0,171
Temperature range II: 50°C/72°C	δ_{N0} -factor	[mm/(N/mm ²)]	0,095	0,096	0,099	0,102	0,106	0,110
	$\delta_{N\infty}$ -factor	[mm/(N/mm ²)]	0,154	0,163	0,172	0,181	0,189	0,229
Temperature range III: 60°C/80°C	δ_{N0} -factor	[mm/(N/mm ²)]	0,095	0,096	0,099	0,102	0,106	0,110
	$\delta_{N\infty}$ -factor	[mm/(N/mm ²)]	0,154	0,163	0,172	0,181	0,189	0,229

1) Calculation of the displacement: $\delta_{N0} = \delta_{N0}\text{-factor} \cdot \tau$; $\delta_{N\infty} = \delta_{N\infty}\text{-factor} \cdot \tau$; τ : action bond stress for tension

Table C22: Displacements under tension load¹⁾ in diamond drilled holes (DD)

Internal threaded anchor rods			IG-M6	IG-M8	IG-M10	IG-M12	IG-M16	IG-M20
Cracked and uncracked concrete under static and quasi-static action for a working life of 50 years								
Temperature range I: 24°C/40°C	δ_{N0} -factor	[mm/(N/mm ²)]	0,012	0,012	0,013	0,014	0,014	0,015
	$\delta_{N\infty}$ -factor	[mm/(N/mm ²)]	0,019	0,019	0,020	0,022	0,023	0,025
Temperature range II: 50°C/72°C	δ_{N0} -factor	[mm/(N/mm ²)]	0,014	0,014	0,015	0,016	0,016	0,018
	$\delta_{N\infty}$ -factor	[mm/(N/mm ²)]	0,053	0,055	0,058	0,062	0,065	0,070
Temperature range III: 60°C/80°C	δ_{N0} -factor	[mm/(N/mm ²)]	0,014	0,014	0,015	0,016	0,016	0,018
	$\delta_{N\infty}$ -factor	[mm/(N/mm ²)]	0,053	0,055	0,058	0,062	0,065	0,070
Uncracked concrete under static and quasi-static action for a working life of 100 years								
Temperature range I: 24°C/40°C	δ_{N0} -factor	[mm/(N/mm ²)]	0,012	0,012	0,013	0,014	0,014	0,015
	$\delta_{N\infty}$ -factor	[mm/(N/mm ²)]	0,021	0,021	0,023	0,024	0,025	0,027
Temperature range II: 50°C/72°C	δ_{N0} -factor	[mm/(N/mm ²)]	0,014	0,014	0,015	0,016	0,016	0,018
	$\delta_{N\infty}$ -factor	[mm/(N/mm ²)]	0,039	0,040	0,043	0,045	0,047	0,051
Temperature range III: 60°C/80°C	δ_{N0} -factor	[mm/(N/mm ²)]	0,014	0,014	0,015	0,016	0,016	0,018
	$\delta_{N\infty}$ -factor	[mm/(N/mm ²)]	0,039	0,040	0,043	0,045	0,047	0,051

1) Calculation of the displacement: $\delta_{N0} = \delta_{N0}\text{-factor} \cdot \tau$; $\delta_{N\infty} = \delta_{N\infty}\text{-factor} \cdot \tau$; τ : action bond stress for tension

Table C23: Displacements under shear load¹⁾ for all drilling methods

Internal threaded anchor rods			IG-M6	IG-M8	IG-M10	IG-M12	IG-M16	IG-M20
Uncracked and cracked concrete under static and quasi-static action for a working life of 50 and 100 years								
All temperature ranges	δ_{V0} -factor	[mm/kN]	0,07	0,06	0,06	0,05	0,04	0,04
	$\delta_{V\infty}$ -factor	[mm/kN]	0,10	0,09	0,08	0,08	0,06	0,06

1) Calculation of the displacement $\delta_{V0} = \delta_{V0}\text{-factor} \cdot V$; $\delta_{V\infty} = \delta_{V\infty}\text{-factor} \cdot V$; V : action shear load

Chemofast Injection system EP 1000 for concrete	Annex C 19
Performances Displacements under static and quasi-static action for a working life of 50 and 100 years (Internal threaded anchor rod)	

Table C24: Displacements under tension load¹⁾ in hammer drilled holes (HD), comp. air drilled holes (CD) and in hammer drilled holes with hollow drill bit (HDB)

Reinforcing bar		Ø 8	Ø 10	Ø 12	Ø 14	Ø 16	Ø 20	Ø 24	Ø 25	Ø 28	Ø 32	Ø 36	Ø 40	
Uncracked concrete under static and quasi-static action for a working life of 50 and 100 years														
Temp.- range I: 24°C/40°C	δ_{NO} -factor	[mm/(N/mm ²)]	0,028	0,029	0,030	0,031	0,033	0,035	0,038	0,038	0,040	0,043	0,045	0,047
	$\delta_{N\infty}$ -factor	[mm/(N/mm ²)]	0,028	0,029	0,030	0,031	0,033	0,035	0,038	0,038	0,040	0,043	0,045	0,047
Temp.- range II: 50°C/72°C	δ_{NO} -factor	[mm/(N/mm ²)]	0,038	0,039	0,040	0,042	0,044	0,047	0,051	0,051	0,054	0,058	0,060	0,063
	$\delta_{N\infty}$ -factor	[mm/(N/mm ²)]	0,047	0,049	0,051	0,053	0,055	0,059	0,065	0,065	0,068	0,072	0,074	0,079
Temp.- range III: 60°C/80°C	δ_{NO} -factor	[mm/(N/mm ²)]	0,038	0,039	0,040	0,042	0,044	0,047	0,051	0,051	0,054	0,058	0,060	0,063
	$\delta_{N\infty}$ -factor	[mm/(N/mm ²)]	0,047	0,049	0,051	0,053	0,055	0,059	0,065	0,065	0,068	0,072	0,074	0,079
Cracked concrete under static and quasi-static action for a working life of 50 and 100 years														
Temp.- range I: 24°C/40°C	δ_{NO} -factor	[mm/(N/mm ²)]	0,069	0,071	0,072	0,073	0,074	0,076	0,079	0,079	0,081	0,084	2)	
	$\delta_{N\infty}$ -factor	[mm/(N/mm ²)]	0,115	0,122	0,128	0,135	0,142	0,155	0,171	0,171	0,181	0,194		
Temp.- range II: 50°C/72°C	δ_{NO} -factor	[mm/(N/mm ²)]	0,092	0,095	0,096	0,098	0,099	0,102	0,106	0,106	0,109	0,113		
	$\delta_{N\infty}$ -factor	[mm/(N/mm ²)]	0,154	0,163	0,172	0,181	0,189	0,207	0,229	0,229	0,242	0,260		
Temp.- range III: 60°C/80°C	δ_{NO} -factor	[mm/(N/mm ²)]	0,092	0,095	0,096	0,098	0,099	0,102	0,106	0,106	0,109	0,113		
	$\delta_{N\infty}$ -factor	[mm/(N/mm ²)]	0,154	0,163	0,172	0,181	0,189	0,207	0,229	0,229	0,242	0,260		

1) Calculation of the displacement: $\delta_{NO} = \delta_{NO\text{-factor}} \cdot \tau$; $\delta_{N\infty} = \delta_{N\infty\text{-factor}} \cdot \tau$; τ : action bond stress for tension

2) No performance assessed

Table C25: Displacements under tension load¹⁾ in diamond drilled holes (DD)

Reinforcing bar		Ø 8	Ø 10	Ø 12	Ø 14	Ø 16	Ø 20	Ø 24	Ø 25	Ø 28	Ø 32	Ø 36	Ø 40	
Uncracked concrete under static and quasi-static action for a working life of 50 years														
Temp.- range I: 24°C/40°C	δ_{NO} -factor	[mm/(N/mm ²)]	0,008	0,009	0,009	0,01	0,011	0,012	0,013	0,013	0,014	0,015	0,016	0,017
	$\delta_{N\infty}$ -factor	[mm/(N/mm ²)]	0,018	0,018	0,019	0,020	0,021	0,024	0,027	0,027	0,028	0,031	0,032	0,034
Temp.- range II: 50°C/72°C	δ_{NO} -factor	[mm/(N/mm ²)]	0,009	0,011	0,011	0,012	0,013	0,014	0,015	0,015	0,016	0,018	0,019	0,020
	$\delta_{N\infty}$ -factor	[mm/(N/mm ²)]	0,048	0,051	0,054	0,058	0,061	0,068	0,076	0,076	0,081	0,088	0,090	0,097
Temp.- range III: 60°C/80°C	δ_{NO} -factor	[mm/(N/mm ²)]	0,009	0,011	0,011	0,012	0,013	0,014	0,015	0,015	0,016	0,018	0,019	0,020
	$\delta_{N\infty}$ -factor	[mm/(N/mm ²)]	0,048	0,051	0,054	0,058	0,061	0,068	0,076	0,076	0,081	0,088	0,090	0,097
Uncracked concrete under static and quasi-static action for a working life of 100 years														
Temp.- range I: 24°C/40°C	δ_{NO} -factor	[mm/(N/mm ²)]	0,008	0,009	0,009	0,010	0,011	0,012	0,013	0,013	0,014	0,015	0,016	0,017
	$\delta_{N\infty}$ -factor	[mm/(N/mm ²)]	0,018	0,020	0,021	0,022	0,024	0,026	0,029	0,029	0,031	0,034	0,035	0,037
Temp.- range II: 50°C/72°C	δ_{NO} -factor	[mm/(N/mm ²)]	0,009	0,011	0,011	0,012	0,013	0,014	0,015	0,015	0,016	0,018	0,019	0,020
	$\delta_{N\infty}$ -factor	[mm/(N/mm ²)]	0,035	0,037	0,040	0,042	0,045	0,049	0,055	0,055	0,059	0,064	0,066	0,070
Temp.- range III: 60°C/80°C	δ_{NO} -factor	[mm/(N/mm ²)]	0,009	0,011	0,011	0,012	0,013	0,014	0,015	0,015	0,016	0,018	0,019	0,020
	$\delta_{N\infty}$ -factor	[mm/(N/mm ²)]	0,035	0,037	0,040	0,042	0,045	0,049	0,055	0,055	0,059	0,064	0,066	0,070

1) Calculation of the displacement: $\delta_{NO} = \delta_{NO\text{-factor}} \cdot \tau$; $\delta_{N\infty} = \delta_{N\infty\text{-factor}} \cdot \tau$; τ : action bond stress for tension

Table C26: Displacements under shear load¹⁾ for all drilling methods

Reinforcing bar		Ø 8	Ø 10	Ø 12	Ø 14	Ø 16	Ø 20	Ø 24	Ø 25	Ø 28	Ø 32	Ø 36	Ø 40
Uncracked and cracked concrete under static and quasi-static action for a working life of 50 and 100 years													
All temperature ranges	δ_{V0} -factor	[mm/kN]	0,06	0,05	0,05	0,04	0,04	0,04	0,03	0,03	0,03	0,03	0,03
	$\delta_{V\infty}$ -factor	[mm/kN]	0,09	0,08	0,08	0,06	0,06	0,05	0,05	0,05	0,04	0,04	0,04

1) Calculation of the displacement $\delta_{V0} = \delta_{V0\text{-factor}} \cdot V$; $\delta_{V\infty} = \delta_{V\infty\text{-factor}} \cdot V$; V : action shear load

Chemofast Injection system EP 1000 for concrete	Annex C 20
Performances Displacements under static and quasi-static action for a working life of 50 and 100 years (reinforcing bar)	

Table C27: Characteristic values of tension loads under seismic action (performance category C1) for a working life of 50 years													
Threaded rod				M8	M10	M12	M16	M20	M24	M27	M30		
Steel failure													
Characteristic tension resistance				$N_{Rk,s,eq,C1}$	[kN]	$1,0 \cdot N_{Rk,s}$							
Partial factor				$\gamma_{Ms,N}$	[-]	see Table C1							
Combined pull-out and concrete failure													
Characteristic bond resistance in cracked and uncracked concrete C20/25 in hammer drilled holes (HD), compressed air drilled holes (CD) and in hammer drilled holes with hollow drill bit (HDB)													
Temperature range	I: 24°C/40°C	Dry, wet concrete and flooded bore hole	$\tau_{Rk,eq,C1}$	[N/mm ²]	7,0	7,0	8,5	8,5	8,5	8,5	8,5	8,5	8,5
	II: 50°C/72°C		$\tau_{Rk,eq,C1}$	[N/mm ²]	6,0	6,0	7,0	7,0	7,0	7,0	7,0	7,0	7,0
	III: 60°C/80°C		$\tau_{Rk,eq,C1}$	[N/mm ²]	5,0	5,0	5,0	4,5	4,5	4,5	4,5	4,5	4,5
Increasing factors for concrete				ψ_c	[-]	1,0							
Characteristic bond resistance depending on the concrete strength class				$\tau_{Rk,eq,C1} =$		$\psi_c \cdot \tau_{Rk,eq,C1,(C20/25)}$							
Installation factor													
for dry and wet concrete (HD; HDB, CD)				γ_{inst}	[-]	1,0							
for flooded bore hole (HD; HDB, CD)						1,2							
Chemofast Injection system EP 1000 for concrete											Annex C 21		
Performances Characteristic values of tension loads under seismic action (performance category C1) for a working life of 50 years (threaded rod)													

Table C28: Characteristic values of tension loads under seismic action (performance category C1) for a working life of 100 years												
Threaded rod				M8	M10	M12	M16	M20	M24	M27	M30	
Steel failure												
Characteristic tension resistance		$N_{Rk,s,eq,C1}$	[kN]	$1,0 \cdot N_{Rk,s}$								
Partial factor		$\gamma_{Ms,N}$	[-]	see Table C1								
Combined pull-out and concrete failure												
Characteristic bond resistance in cracked and uncracked concrete C20/25 in hammer drilled holes (HD), compressed air drilled holes (CD) and in hammer drilled holes with hollow drill bit (HDB)												
Temperature range	I: 24°C/40°C	Dry, wet concrete and flooded bore hole	$\tau_{Rk,eq,C1}$	[N/mm ²]	6,5	6,5	7,5	7,5	7,5	7,5	7,5	7,5
	II: 50°C/72°C		$\tau_{Rk,eq,C1}$	[N/mm ²]	5,5	5,5	6,5	6,5	6,5	6,5	6,5	6,5
	III: 60°C/80°C		$\tau_{Rk,eq,C1}$	[N/mm ²]	5,0	5,0	5,0	4,5	4,5	4,5	4,5	4,5
Increasing factors for concrete			ψ_c	[-]	1,0							
Characteristic bond resistance depending on the concrete strength class			$\tau_{Rk,eq,C1} =$		$\psi_c \cdot \tau_{Rk,eq,C1,(C20/25)}$							
Installation factor												
for dry and wet concrete (HD; HDB, CD)		γ_{inst}	[-]	1,0								
for flooded bore hole (HD; HDB, CD)				1,2								
Chemofast Injection system EP 1000 for concrete										Annex C 22		
Performances Characteristic values of tension loads under seismic action (performance category C1) for a working life of 100 years (threaded rod)												

Table C29: Characteristic values of shear loads under seismic action (performance category C1) for a working life of 50 and 100 years								
Threaded rod	M8	M10	M12	M16	M20	M24	M27	M30
Steel failure								
Characteristic shear resistance (Seismic C1)	$V_{Rk,s,eq,C1}$	[kN]	$0,70 \cdot V_{Rk,s}^0$					
Partial factor	$\gamma_{Ms,V}$	[-]	see Table C1					
Factor for annular gap	α_{gap}	[-]	0,5 (1,0) ¹⁾					
<p>¹⁾ Value in brackets valid for filled annular gab between fastener and clearance hole in the fixture. Use of special filling washer Annex A 3 is recommended.</p>								
Chemofast Injection system EP 1000 for concrete							Annex C 23	
<p>Performances Characteristic values of shear loads under seismic action (performance category C1) for a working life of 50 and 100 years (threaded rod)</p>								

Table C30: Characteristic values of tension loads under seismic action (performance category C1) for a working life of 50 years													
Reinforcing bar			Ø 8	Ø 10	Ø 12	Ø 14	Ø 16	Ø 20	Ø 24	Ø 25	Ø 28	Ø 32	
Steel failure													
Characteristic tension resistance	$N_{Rk,s,eq,C1}$	[kN]	$1,0 \cdot A_s \cdot f_{uk}^{1)}$										
Cross section area	A_s	[mm ²]	50	79	113	154	201	314	452	491	616	804	
Partial factor	$\gamma_{Ms,N}$	[-]	1,4 ²⁾										
Combined pull-out and concrete failure													
Characteristic bond resistance in cracked and uncracked concrete C20/25 in hammer drilled holes (HD), compressed air drilled holes (CD) and in hammer drilled holes with hollow drill bit (HDB)													
Temperature range	I: 24°C/40°C	Dry, wet concrete and flooded bore hole	$\tau_{Rk,eq,C1}$	[N/mm ²]	7,0	7,0	8,5	8,5	8,5	8,5	8,5	8,5	8,5
	II: 50°C/72°C		$\tau_{Rk,eq,C1}$	[N/mm ²]	6,0	6,0	7,0	7,0	7,0	7,0	7,0	7,0	7,0
	III: 60°C/80°C		$\tau_{Rk,eq,C1}$	[N/mm ²]	4,5	4,5	4,5	4,5	4,5	4,5	4,5	4,5	4,5
Increasing factors for concrete		ψ_c	[-]	1,0									
Characteristic bond resistance depending on the concrete strength class		$\tau_{Rk,eq,C1} =$		$\psi_c \cdot \tau_{Rk,eq,C1,(C20/25)}$									
Installation factor													
for dry and wet concrete (HD; HDB, CD)		γ_{inst}	[-]	1,0									
for flooded bore hole (HD; HDB, CD)				1,2									
¹⁾ f_{uk} shall be taken from the specifications of reinforcing bars ²⁾ in absence of national regulation													
Chemofast Injection system EP 1000 for concrete											Annex C 24		
Performances Characteristic values of tension loads under seismic action (performance category C1) for a working life of 50 years (reinforcing bar)													

Table C31: Characteristic values of tension loads under seismic action (performance category C1) for a working life of 100 years

Reinforcing bar			Ø 8	Ø 10	Ø 12	Ø 14	Ø 16	Ø 20	Ø 24	Ø 25	Ø 28	Ø 32	
Steel failure													
Characteristic tension resistance	$N_{Rk,s,eq,C1}$	[kN]	$1,0 \cdot A_s \cdot f_{uk}^{1)}$										
Cross section area	A_s	[mm ²]	50	79	113	154	201	314	452	491	616	804	
Partial factor	$\gamma_{Ms,N}$	[-]	1,4 ²⁾										
Combined pull-out and concrete failure													
Characteristic bond resistance in cracked and uncracked concrete C20/25 in hammer drilled holes (HD), compressed air drilled holes (CD) and in hammer drilled holes with hollow drill bit (HDB)													
Temperature range	I: 24°C/40°C	Dry, wet concrete and flooded bore hole	$\tau_{Rk,eq,C1}$	[N/mm ²]	6,5	6,5	7,5	7,5	7,5	7,5	7,5	7,5	7,5
	II: 50°C/72°C		$\tau_{Rk,eq,C1}$	[N/mm ²]	5,5	5,5	6,5	6,5	6,5	6,5	6,5	6,5	6,5
	III: 60°C/80°C		$\tau_{Rk,eq,C1}$	[N/mm ²]	4,5	4,5	4,5	4,5	4,5	4,5	4,5	4,5	4,5
Increasing factors for concrete		ψ_c	[-]	1,0									
Characteristic bond resistance depending on the concrete strength class		$\tau_{Rk,eq,C1} =$		$\psi_c \cdot \tau_{Rk,eq,C1,(C20/25)}$									
Installation factor													
for dry and wet concrete (HD; HDB, CD)		γ_{inst}	[-]	1,0									
for flooded bore hole (HD; HDB, CD)				1,2									
<p>1) f_{uk} shall be taken from the specifications of reinforcing bars</p> <p>2) in absence of national regulation</p>													
Chemofast Injection system EP 1000 for concrete										Annex C 25			
<p>Performances Characteristic values of tension loads under seismic action (performance category C1) for a working life of 100 years (reinforcing bar)</p>													

Table C32: Characteristic values of shear loads under seismic action (performance category C1) for a working life of 50 and 100 years												
Reinforcing bar			Ø 8	Ø 10	Ø 12	Ø 14	Ø 16	Ø 20	Ø 24	Ø 25	Ø 28	Ø 32
Steel failure												
Characteristic shear resistance	$V_{Rk,s,eq,C1}$	[kN]	$0,35 \cdot A_s \cdot f_{uk}^{1)}$									
Cross section area	A_s	[mm ²]	50	79	113	154	201	314	452	491	616	804
Partial factor	$\gamma_{Ms,V}$	[-]	1,5 ²⁾									
Factor for annular gap	α_{gap}	[-]	0,5 (1,0) ³⁾									
<p>1) f_{uk} shall be taken from the specifications of reinforcing bars</p> <p>2) in absence of national regulation</p> <p>3) Value in brackets valid for filled annular gap between fastener and clearance hole in the fixture. Use of special filling washer Annex A 3 is recommended.</p>												
Chemofast Injection system EP 1000 for concrete											Annex C 26	
Performances Characteristic values of shear loads under seismic action (performance category C1) for a working life of 50 and 100 years (reinforcing bar)												

Table C33: Characteristic values of tension loads under seismic action (performance category C2) for a working life of 50 and 100 years											
Threaded rod			M12	M16	M20	M24	M27	M30			
Steel failure											
Characteristic tension resistance, Steel, strength class 8.8 Stainless Steel A4 and HCR, Strength class ≥ 70			$N_{Rk,s,eq,C2}$	[kN]	$1,0 \cdot N_{Rk,s}$						
Partial factor			$\gamma_{Ms,N}$	[-]	see Table C1						
Combined pull-out and concrete failure											
Characteristic bond resistance in cracked and uncracked concrete C20/25 in hammer drilled holes (HD), compressed air drilled holes (CD) and in hammer drilled holes with hollow drill bit (HDB)											
Temperature range	I: 24°C/40°C	Dry, wet concrete and flooded bore hole	$\tau_{Rk,eq,C2}$	[N/mm ²]	5,8	4,8	5,0	5,1	4,8	5,0	
	II: 50°C/72°C		$\tau_{Rk,eq,C2}$	[N/mm ²]	5,0	4,1	4,3	4,4	4,1	4,3	
	III: 60°C/80°C		$\tau_{Rk,eq,C2}$	[N/mm ²]	1,9	1,6	1,6	1,7	1,5	1,6	
Increasing factors for concrete			ψ_c	[-]	1,0						
Characteristic bond resistance depending on the concrete strength class			$\tau_{Rk,eq,C2} =$		$\psi_c \cdot \tau_{Rk,eq,C2,(C20/25)}$						
Installation factor											
for dry and wet concrete (HD; HDB, CD)			γ_{inst}	[-]	1,0						
for flooded bore hole (HD; HDB, CD)					1,2						
Table C34: Characteristic values of shear loads under seismic action (performance category C2) for a working life of 50 and 100 years											
Threaded rod			M12	M16	M20	M24	M27	M30			
Steel failure											
Characteristic shear resistance Steel, strength class 8.8 Stainless Steel A4 and HCR, Strength class ≥ 70			$V_{Rk,s,eq,C2}$	[kN]	$0,70 \cdot V_{Rk,s}^0$						
Partial factor			$\gamma_{Ms,V}$	[-]	see Table C1						
Factor for annular gap			α_{gap}	[-]	0,5 (1,0) ¹⁾						
1) Value in brackets valid for filled annular gap between fastener and clearance hole in the fixture. Use of special filling washer Annex A 3 is recommended.											
Chemofast Injection system EP 1000 for concrete								Annex C 27			
Performances Characteristic values of tension and shear loads under seismic action (performance category C2) for a working life of 50 and 100 years (threaded rod)											

Table C35: Displacements under tension load (threaded rod)								
Threaded rod			M12	M16	M20	M24	M27	M30
Uncracked and cracked concrete under seismic action (performance category C2) for a working life of 50 and 100 years								
All temperature ranges	$\delta_{N,eq,C2(50\%)} =$	[mm]	0,21	0,24	0,27	0,36	0,92	0,70
	$\delta_{N,eq,C2(DLS)}$							
	$\delta_{N,eq,C2(100\%)} =$	[mm]	0,54	0,51	0,54	0,63	1,70	0,92
	$\delta_{N,eq,C2(ULS)}$							
Table C36: Displacements under shear load (threaded rod)								
Threaded rod			M12	M16	M20	M24	M27	M30
Uncracked and cracked concrete under seismic action (performance category C2) for a working life of 50 and 100 years								
All temperature ranges	$\delta_{V,eq,C2(50\%)} =$	[mm]	3,1	3,4	3,5	4,2	4,0	3,8
	$\delta_{V,eq,C2(DLS)}$							
	$\delta_{V,eq,C2(100\%)} =$	[mm]	6,0	7,6	7,3	10,9	11,1	11,2
	$\delta_{V,eq,C2(ULS)}$							
Chemofast Injection system EP 1000 for concrete							Annex C 28	
Performances Displacements under seismic action (performance category C2) for a working life of 50 and 100 years (threaded rod)								

Table C37: Characteristic values of tension and shear loads under fire exposure in hammer drilled holes (HD), compressed air drilled holes (CD) and in hammer drilled holes with hollow drill bit (HDB)												
Threaded rod				M8	M10	M12	M16	M20	M24	M27	M30	
Steel failure												
Characteristic tension resistance; Steel, Stainless Steel A2, A4 and HCR, strength class 5.8 resp. 50 and higher	$N_{Rk,s,fi}$	[kN]	Fire exposure time [min]	30	1,1	1,7	3,0	5,7	8,8	12,7	16,5	20,2
				60	0,9	1,4	2,3	4,2	6,6	9,5	12,4	15,1
				90	0,7	1,0	1,6	3,0	4,7	6,7	8,7	10,7
				120	0,5	0,8	1,2	2,2	3,4	4,9	6,4	7,9
Characteristic bond resistance in cracked and uncracked concrete C20/25 up to C50/60 under fire conditions for a given temperature θ												
Temperature reduction factor	$k_{fi,p}(\theta)$	[-]	$\theta < 23^\circ\text{C}$		1,0							
			$23^\circ\text{C} \leq \theta \leq 278^\circ\text{C}$		$150,28 \cdot \theta^{-1,598} \leq 1,0$							
			$\theta > 278^\circ\text{C}$		0,0							
Characteristic bond resistance for a given temperature (θ)	$\tau_{Rk,fi}(\theta)$	[N/mm ²]		$k_{fi,p}(\theta) \cdot \tau_{Rk,cr,(C20/25)}^{1)}$								
Steel failure without lever arm												
Characteristic shear resistance; Steel, Stainless Steel A2, A4 and HCR, strength class 5.8 resp. 50 and higher	$V_{Rk,s,fi}$	[kN]	Fire exposure time [min]	30	1,1	1,7	3,0	5,7	8,8	12,7	16,5	20,2
				60	0,9	1,4	2,3	4,2	6,6	9,5	12,4	15,1
				90	0,7	1,0	1,6	3,0	4,7	6,7	8,7	10,7
				120	0,5	0,8	1,2	2,2	3,4	4,9	6,4	7,9
Steel failure with lever arm												
Characteristic bending moment; Steel, Stainless Steel A2, A4 and HCR, strength class 5.8 resp. 50 and higher	$M^0_{Rk,s,fi}$	[Nm]	Fire exposure time [min]	30	1,1	2,2	4,7	12,0	23,4	40,4	59,9	81,0
				60	0,9	1,8	3,5	9,0	17,5	30,3	44,9	60,7
				90	0,7	1,3	2,5	6,3	12,3	21,3	31,6	42,7
				120	0,5	1,0	1,8	4,7	9,1	15,7	23,3	31,5
¹⁾ $\tau_{Rk,cr,(C20/25)}$ characteristic bond resistance for cracked concrete for concrete strength class C20/25 for the relevant temperature range and working life.												
Chemofast Injection system EP 1000 for concrete										Annex C 29		
Performances Characteristic values of tension and shear loads under fire exposure (threaded rod)												

Table C38: Characteristic values of tension and shear loads under fire exposure in hammer drilled holes (HD), compressed air drilled holes (CD) and in hammer drilled holes with hollow drill bit (HDB)										
Internal threaded anchor rods				IG-M6	IG-M8	IG-M10	IG-M12	IG-M16	IG-M20	
Steel failure										
Characteristic tension resistance; Steel, Stainless Steel A4 and HCR, strength class 5.8 and 8.8 resp. 70	$N_{Rk,s,fi}$	[kN]	Fire exposure time [min]	30	0,3	1,1	1,7	3,0	5,7	8,8
				60	0,2	0,9	1,4	2,3	4,2	6,6
				90	0,2	0,7	1,0	1,6	3,0	4,7
				120	0,1	0,5	0,8	1,2	2,2	3,4
Characteristic bond resistance in cracked and uncracked concrete C20/25 up to C50/60 under fire conditions for a given temperature θ										
Temperature reduction factor	$k_{fi,p}(\theta)$	[-]	$\theta < 23^\circ\text{C}$		1,0					
			$23^\circ\text{C} \leq \theta \leq 278^\circ\text{C}$		$150,28 \cdot \theta^{-1,598} \leq 1,0$					
			$\theta > 278^\circ\text{C}$		0,0					
Characteristic bond resistance for a given temperature (θ)	$\tau_{Rk,fi}(\theta)$	[N/mm ²]		$k_{fi,p}(\theta) \cdot \tau_{Rk,cr,(C20/25)}^{1)}$						
Steel failure without lever arm										
Characteristic shear resistance; Steel, Stainless Steel A4 and HCR, strength class 5.8 and 8.8 resp. 70	$V_{Rk,s,fi}$	[kN]	Fire exposure time [min]	30	0,3	1,1	1,7	3,0	5,7	8,8
				60	0,2	0,9	1,4	2,3	4,2	6,6
				90	0,2	0,7	1,0	1,6	3,0	4,7
				120	0,1	0,5	0,8	1,2	2,2	3,4
Steel failure with lever arm										
Characteristic bending moment; Steel, Stainless Steel A4 and HCR, strength class 5.8 and 8.8 resp. 70	$M^0_{Rk,s,fi}$	[Nm]	Fire exposure time [min]	30	0,2	1,1	2,2	4,7	12,0	23,4
				60	0,2	0,9	1,8	3,5	9,0	17,5
				90	0,1	0,7	1,3	2,5	6,3	12,3
				120	0,1	0,5	1,0	1,8	4,7	9,1
¹⁾ $\tau_{Rk,cr,(C20/25)}$ characteristic bond resistance for cracked concrete for concrete strength class C20/25 for the relevant temperature range and working life.										
Chemofast Injection system EP 1000 for concrete									Annex C 30	
Performances Characteristic values of tension and shear loads under fire exposure (internal threaded anchor rod)										

Table C39: Characteristic values of tension and shear loads under fire exposure in hammer drilled holes (HD), compressed air drilled holes (CD) and in hammer drilled holes with hollow drill bit (HDB)														
Reinforcing bar				Ø 8	Ø 10	Ø 12	Ø 14	Ø 16	Ø 20	Ø 24	Ø 25	Ø 28	Ø 32	
Steel failure														
Characteristic tension resistance; BSt 500	$N_{Rk,s,fi}$	[kN]	Fire exposure time [min]	30	0,5	1,2	2,3	3,1	4,0	6,3	9,0	9,8	12,3	16,1
				60	0,5	1,0	1,7	2,3	3,0	4,7	6,8	7,4	9,2	12,1
				90	0,4	0,8	1,5	2,0	2,6	4,1	5,9	6,4	8,0	10,5
				120	0,3	0,6	1,1	1,5	2,0	3,1	4,5	4,9	6,2	8,0
Characteristic bond resistance in cracked and uncracked concrete C20/25 up to C50/60 under fire conditions for a given temperature θ														
Temperature reduction factor	$k_{fi,p}(\theta)$	[-]	$\theta < 25^\circ\text{C}$		1,0									
			$25^\circ\text{C} \leq \theta \leq 278^\circ\text{C}$		$176,37 \cdot \theta^{-1,598} \leq 1,0$									
			$\theta > 278^\circ\text{C}$		0,0									
Characteristic bond resistance for a given temperature (θ)	$\tau_{Rk,fi}(\theta)$	[N/mm ²]		$k_{fi,p}(\theta) \cdot \tau_{Rk,cr,(C20/25)}^1$										
Steel failure without lever arm														
Characteristic shear resistance; BSt 500	$V_{Rk,s,fi}$	[kN]	Fire exposure time [min]	30	0,5	1,2	2,3	3,1	4,0	6,3	9,0	9,8	12,3	16,1
				60	0,5	1,0	1,7	2,3	3,0	4,7	6,8	7,4	9,2	12,1
				90	0,4	0,8	1,5	2,0	2,6	4,1	5,9	6,4	8,0	10,5
				120	0,3	0,6	1,1	1,5	2,0	3,1	4,5	4,9	6,2	8,0
Steel failure with lever arm														
Characteristic bending moment; BSt 500	$M^0_{Rk,s,fi}$	[Nm]	Fire exposure time [min]	30	0,6	1,8	4,1	6,5	9,7	18,8	32,6	36,8	51,7	77,2
				60	0,5	1,5	3,1	4,8	7,2	14,1	24,4	27,6	38,8	57,9
				90	0,4	1,2	2,6	4,2	6,3	12,3	21,2	23,9	33,6	50,2
				120	0,3	0,9	2,0	3,2	4,8	9,4	16,3	18,4	25,9	38,6
¹⁾ $\tau_{Rk,cr,(C20/25)}$ characteristic bond resistance for cracked concrete for concrete strength class C20/25 for the relevant temperature range and working life.														
Chemofast Injection system EP 1000 for concrete											Annex C 31			
Performances Characteristic values of tension and shear loads under fire exposure (reinforcing bar)														