

Public-law institution jointly founded by the federal states and the Federation

European Technical Assessment Body
for construction products



European Technical Assessment

ETA-25/0855
of 11 February 2026

English translation prepared by DIBt - Original version in German language

General Part

Technical Assessment Body issuing the European Technical Assessment:

Deutsches Institut für Bautechnik

Trade name of the construction product

TOX screw anchor Sumo Max 1 A4

Product family
to which the construction product belongs

Screw anchor for use in masonry

Manufacturer

TOX-Dübel-Technik GmbH
Brunnenstraße 31
72505 Krauchenwies
GERMANY

Manufacturing plant

Werk 1

This European Technical Assessment
contains

36 pages including 3 annexes which form an integral part
of this assessment

This European Technical Assessment is
issued in accordance with Article 95(4) of
Regulation (EU) No 2024/3110, on the basis of

EAD 330460-00-0604

The European Technical Assessment is issued by the Technical Assessment Body in its official language. Translations of this European Technical Assessment in other languages shall fully correspond to the original issued document and shall be identified as such.

Communication of this European Technical Assessment, including transmission by electronic means, shall be in full. However, partial reproduction may only be made with the written consent of the issuing Technical Assessment Body. Any partial reproduction shall be identified as such.

This European Technical Assessment may be withdrawn by the issuing Technical Assessment Body, in particular pursuant to information by the Commission in accordance with Article 36(3) of Regulation (EU) No 2024/3110.

Specific Part

1 Technical description of the product

The TOX screw anchor Sumo Max 1 A4 is an anchor in size 6, 8 and 10 mm made of stainless steel. The anchor is screwed into a predrilled cylindrical drill hole. The special thread of the anchor cuts an internal thread into the member while setting. The anchorage is characterised by mechanical interlock in the special thread.

Product and product description are given in Annex A.

2 Specification of the intended use in accordance with the applicable European Assessment Document

The performances given in Section 3 are only valid if the anchor is used in compliance with the specifications and conditions given in Annex B.

The verifications and assessment methods on which this European Technical Assessment is based lead to the assumption of a working life of the anchors of at least 50 years. The indications given on the working life cannot be interpreted as a guarantee given by the producer, but are to be regarded only as a means for choosing the right products in relation to the expected economically reasonable working life of the works.

3 Performance of the product and references to the methods used for its assessment

3.1 Mechanical resistance and stability (BWR 1)

Essential characteristic	Performance
Characteristic resistance to steel failure of a single screw anchor under tension loading	$N_{Rk,s}$ see Annex C1
Characteristic resistance to steel failure of a single screw anchor under shear loading	$V_{Rk,s}$ [kN], $M_{Rk,s}^0$ see Annex C1
Characteristic resistance to pull-out failure or brick breakout failure of a single screw anchor under tension loading	$N_{Rk,p}$, $N_{Rk,b}$, $N_{Rk,p,c}$, $N_{Rk,b,c}$ see Annex B7, C4, C9, C14, C19 $\alpha_{j,N}$ see Annex C4, C9, C14, C19
Characteristic resistance to local brick failure and brick edge failure of a single screw anchor under shear loading	$V_{Rk,b,II}$, $V_{Rk,b,\perp}$, $V_{Rk,c,II}$, $V_{Rk,c,\perp}$ see Annex B7, C4, C9, C14, C19 $\alpha_{j,VI}$, $\alpha_{j,V\perp}$ see Annex C3, C8, C13, C18
Characteristic resistance to brick breakout failure of a screw anchor group under tension loading	N_{Rk}^g see Annex B7 $\alpha_{g,N}$ see Annex B7, C2, C8, C13, C18
Characteristic resistance to local brick failure and brick edge failure of a screw anchor group under shear loading	$V_{Rk,b,II}^g$, $V_{Rk,b,\perp}^g$, $V_{Rk,c,II}^g$, $V_{Rk,c,\perp}^g$ see Annex B7 $\alpha_{g,VI}$, $\alpha_{g,V\perp}$ see Annex B7, C2, C8, C13, C18
Edge distances, joint distances, spacing, member thickness	C_{cr} , $S_{cr,II}$, $S_{cr,\perp}$ see Annex B7, C3, C8, C13, C18 C_{min} , $C_{j,II}$, $C_{j,\perp}$, $S_{min,II}$, $S_{min,\perp}$ see Annex C3, C8, C13, C18 h_{min} see Annex C3, C7, C12, C17

Essential characteristic	Performance
Resistance to combined tension and shear loading (hollow and perforated bricks)	No performance assessed
Displacements	$\delta_{N0}, \delta_{N\infty}, \delta_{V0}, \delta_{V\infty}$ see Annex C2, C10, C15, C20

3.2 Safety in case of fire (BWR 2)

Essential characteristic	Performance
Reaction to fire	Class A 1
Resistance to fire	$N_{Rk,s,fi}, N_{Rk,p,fi}, N_{Rk,b,fi}, V_{Rk,s,fi}, M^0_{Rk,s,fi}, C_{min,fi}, C_{j,fi}$ see Annex C6, C11, C16, C21 $N_{Rk,fi}, S_{min,fi}, C_{min,fi}, C_{j,fi}$ see Annex C5, C10, C15, C20

3.3 Aspects of durability

Essential characteristic	Performance
Durability	see Annex B1

4 Assessment and verification of constancy of performance (AVCP) system applied, with reference to its legal base

In accordance with the European Assessment Document EAD 330460-00-0604 the applicable European legal act is: 97/177/EC.

The system to be applied is: 1

5 Technical details necessary for the implementation of the AVCP system, as provided for in the applicable European Assessment Document

Technical details necessary for the implementation of the AVCP system are laid down in the control plan deposited at Deutsches Institut für Bautechnik.

Issued in Berlin on 11 February 2026 by Deutsches Institut für Bautechnik

Dipl.-Ing. Beatrix Wittstock
Head of Section

beglaubigt:
Aksünger

Product in installed condition

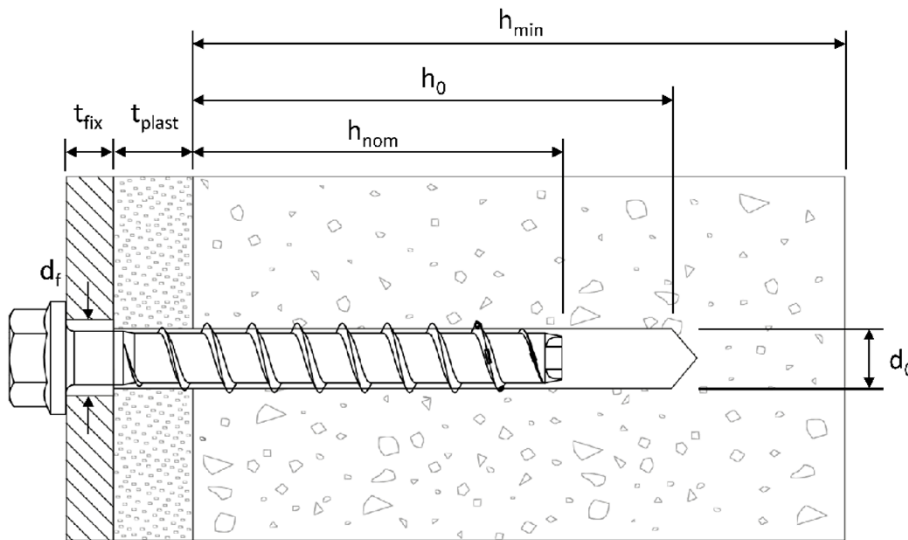

TOX Schraubanker Sumo
Max 1 A4

in solid and perforated
brick with non-load-
bearing layer

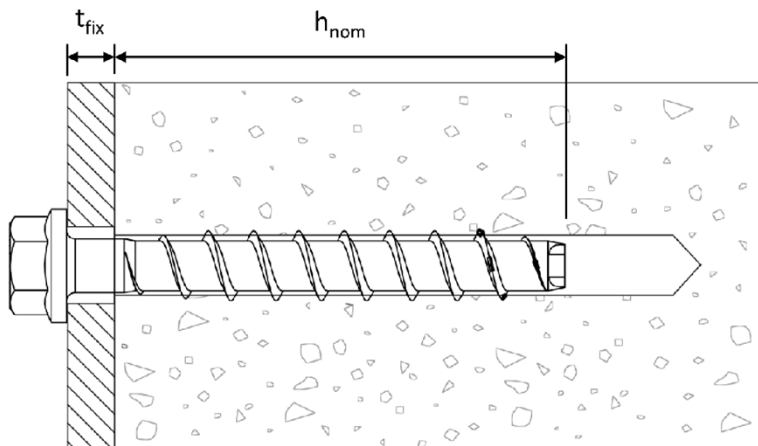

TOX Schraubanker Sumo
Max 1 A4

in solid brick

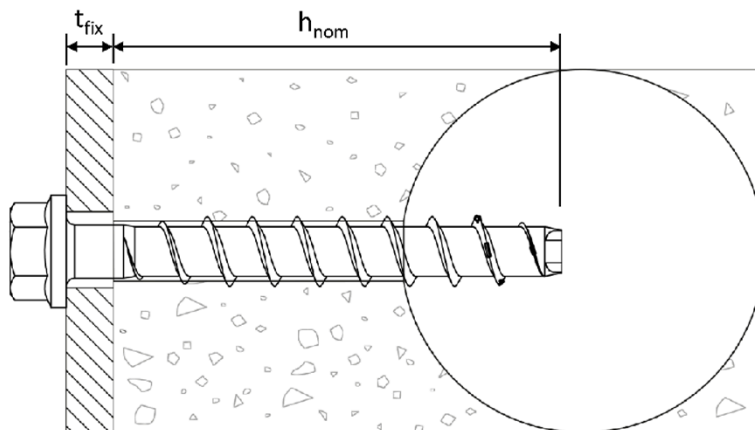

TOX Schraubanker Sumo
Max 1 A4

in perforated brick

d_0 = nominal drill hole diameter
 t_{fix} = thickness of fixture
 d_f = clearance hole diameter
 t_{plast} = thickness of non-load-bearing layer

h_{min} = minimum thickness of member
 h_{nom} = nominal embedment depth
 h_0 = drill hole depth

TOX screw anchor Sumo Max 1 A4

Product description
Product in installed condition

Annex A1











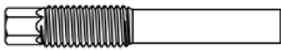

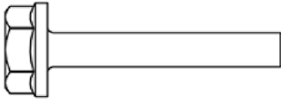

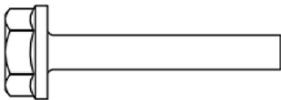

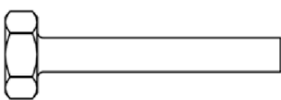

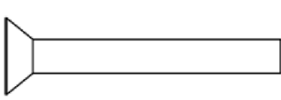

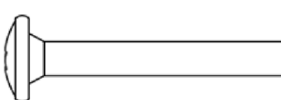
		Configuration with metric connection thread and hexagon drive e.g. TSM 8x105 M10 SW7; Type ST
		Configuration with washer and hexagon head e.g. TSM 8x80 SW13 VZ 40; Type S
		Configuration with washer, hexagon head and TORX drive e.g. TSM 8x80 SW13; Type S
		Configuration with hexagon head e.g. TSM 8x80 SW13 OS; Type S
		Configuration with countersunk head and TORX drive e.g. TSM 8x80 C VZ 40; Type SK
		Configuration with pan head and TORX drive e.g. TSM 8x80 P VZ 40; Type P
		Configuration with large pan head and TORX drive e.g. TSM 8x80 LP VZ 40; Type P
		Configuration with countersunk head and connection thread e.g. TSM 6x55 AG M8; Type ST-6
		Configuration with hexagon drive and connection thread e.g. TSM 6x55 M8 SW10; Type ST-6
		Configuration with internal thread and hexagon drive e.g. TSM 6x55 IM M8/10; Type I
TOX screw anchor Sumo Max 1 A4		Annex A2
Product description Screw types		

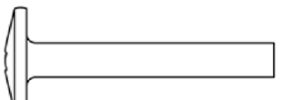
Table 1: Material

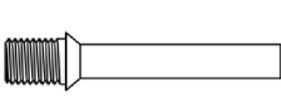
Part	Product name	Material		
All types	TSM A4	1.4401; 1.4404; 1.4571; 1.4578		
	TSM HCR	1.4529		
Part	Product name	Nominal characteristic steel		Elongation A ₅ [%]
		Yield strength f _{yk} [N/mm ²]	Ultimate strength f _{uk} [N/mm ²]	
All types	TSM A4	560	700	≤ 8
	TSM HCR			

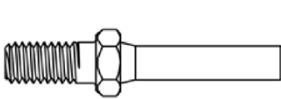
Table 2: Dimensions

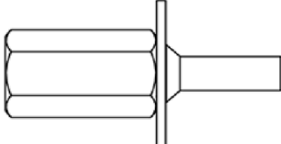
TSM screw size			6	8	10
Nominal embedment depth	h _{nom}		h _{nom1}	h _{nom1}	h _{nom1}
	[mm]		45	55	75
Screw length	≤ L	[mm]	500		
Core diameter	d _k	[mm]	5,1	7,2	9,2
Thread outer diameter	d _s	[mm]	7,6	10,5	12,5

Marking:

TSM A4

Screw type: TSM
Screw size: 10
Screw length: 100
Material: A4

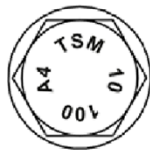

TSM HCR

Screw type: TSM
Screw size: 10
Screw length: 100
Material: HCR

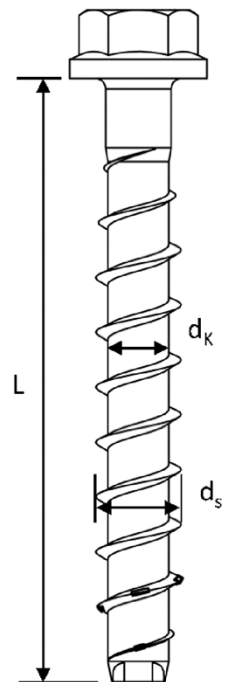

TOX screw anchor Sumo Max 1 A4

Product description
Material, dimensions and markings

Annex A3

Specification of Intended use

Anchorage subject to:

- Static or quasi-static actions in tension, shear or combined tension and shear or bending
- Exposure to fire (for dry masonry only)

Base materials:

- Masonry made of solid bricks and perforated bricks see Annex B3
- Minimum thickness of member h_{min} see Annexes C2, C7, C12, C17
- Bearing joints must be completely filled with mortar of at least compressive strength class M5 according to EN 998-2:2016. Butt joints may, but do not have to be filled with mortar.
- In case of fire, all joints must be completely filled with mortar according to EN 998-2:2016 with strength class at minimum M5
- Dry or wet masonry (during installation)

Use conditions (Environmental conditions):

- Concrete screws subject to dry internal conditions: all screw types.
- For all other conditions corresponding to corrosion resistance classes CRC according to EN 1993-1-4:2006 + A1:2015
 - Stainless steel according to Annex A3, screw with marking A4: CRC III
 - High corrosion resistant steel according to Annex A3, screw with marking HCR: CRC V
- Temperature range of the masonry over the period of use: -40°C to +80°C

Design:

- The anchorage is designed in accordance with EOTA Technical Report TR 054:2022-07.
- Anchorages are to be designed under the responsibility of an engineer experienced in anchorages and masonry work.
- Screws with nominal embedment depth smaller than 50 mm may only be used for anchoring of statically indeterminate systems, in internal exposure conditions.
- Verifiable calculation notes and drawings are to be prepared taking account of the loads to be anchored. The position of the anchor is indicated on the design drawings (e.g. position of the anchor to supports, etc.).
- The screw may be placed in the wall side and in the reveal side of the masonry. The installation parameters for installation in the reveal side must be observed in accordance with Annex B8. In case of Silka XL solid calcium silicate brick KS 12DF, the installation is possible in the wall side only.
- For solid blocks, the characteristic load-bearing capacities also apply to larger block formats, greater compressive strengths and densities of the masonry blocks.
- Installation in the joint and close to the joint is not permitted; the distances to joints according to annexes C3, C8, C13, C18 must be observed.

TOX screw anchor Sumo Max 1 A4

**Intended use
Specification**

Annex B1

Specification of Intended use - continuation

Installation:

- Bridging of non-load-bearing layers (e.g. plaster) is possible. When selecting the screw length L , the thickness of the plaster layer t_{plast} must be considered.
 $L \geq h_{\text{nom}} + t_{\text{plast}} + t_{\text{fix}}$ (see figures in Annex A1)
- During installation, the joint, spacing and edge distances specified by the planner must be considered.
- Anchor installation carried out by appropriately qualified personnel and under the supervision of the person responsible for technical matters on site.
- The borehole is drilled with hammer, percussion, suction or masonry drills in hammer mode or rotary mode. The masonry must not be damaged during hammer drilling. If cracks occur during drilling, the rotary mode must be used. In this case, the drill hole must be discarded.
- Incorrectly drilled holes must be filled with high-strength mortar.

TOX screw anchor Sumo Max 1 A4

Intended use
Specification continuation

Annex B2

Table 3: Solid and perforated bricks, dimensions and properties

	Solid calcium silicate brick KS acc. to EN 771-2:2011+A1:2015				
	Nomenclature	Dimensions [mm]	Mean compressive strength [N/mm ²]	Bulk density [kg/dm ³]	Annex
	KS 20 - 2,0 - NF	L: ≥ 240 B: ≥ 115 H: ≥ 71	≥ 26,0	≥ 2,0	C2 – C6
	Silka XL solid calcium silicate brick KS 12DF acc. to EN 771-2:2015-11				
	Nomenclature	Dimensions [mm]	Mean compressive strength [N/mm ²]	Bulk density [kg/dm ³]	Annex
	KS - R (P) 20 - 2,0 - 12DF	L: ≥ 498 B: ≥ 175 H: ≥ 248	≥ 14,0	≥ 1,8	C7 – C11
	Perforated calcium silicate brick KSL 3DF acc. to EN 771-2:2015-11				
	Nomenclature	Dimensions [mm]	Mean compressive strength [N/mm ²]	Bulk density [kg/dm ³]	Annex
	SWKV KSL 12 - 1,6 - 3DF	L: ≥ 240 B: ≥ 175 H: ≥ 113	≥ 17,0	≥ 1,5	C12 - C16
	Solid clay brick MZ acc. to EN 771-1:2015-11				
	Nomenclature	Dimensions [mm]	Mean compressive strength [N/mm ²]	Bulk density [kg/dm ³]	Annex
	MZ 20 - 2,0 - NF	L: ≥ 240 B: ≥ 115 H: ≥ 71	≥ 21,0	≥ 2,1	C17 – C21

TOX screw anchor Sumo Max 1 A4

Intended use

Solid and perforated bricks, dimensions and properties

Annex B3

Table 4: General installation parameters

TSM screw size			6	8	10
Nominal embedment depth	h_{nom}		h_{nom1}	h_{nom1}	h_{nom1}
	[mm]		45	55	75
Nominal drill hole diameter	d_0	[mm]	6	8	10
Cutting diameter of drill bit	$d_{cut} \leq$	[mm]	6,40	8,45	10,45
Drill hole depth	$h_0 \geq$	[mm]	55	65	85
Clearance hole diameter	$d_f \leq$	[mm]	8	12	14

TOX screw anchor Sumo Max 1 A4

Intended use
General installation parameters

Annex B4

Installation instructions

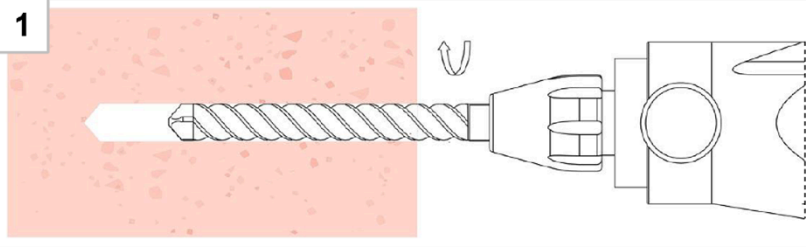
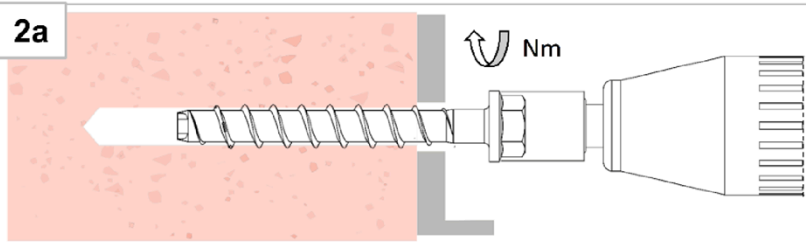
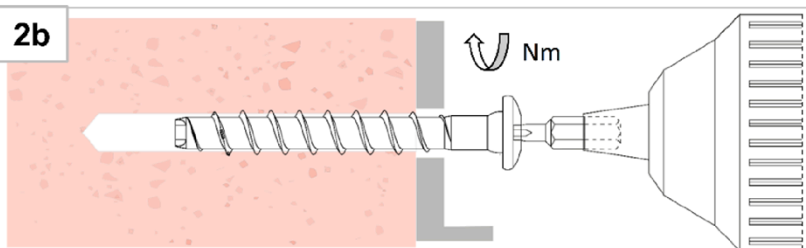
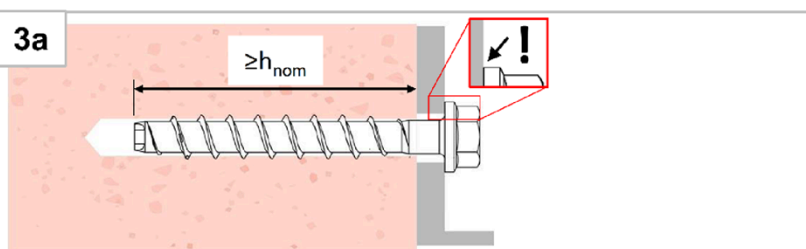
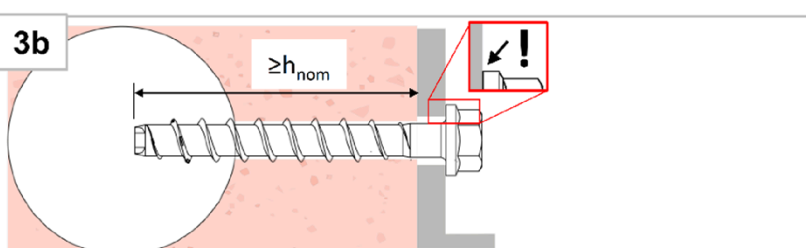
1		Drill hole in hammer mode or rotary mode
2a		Screw in with tangential impact screwdriver, cordless screwdriver or torque wrench
2b		Screw in with tangential impact screwdriver, cordless screwdriver or torque wrench
3a		The head must be undamaged and in contact with fixture.
3b		The head must be undamaged and in contact with fixture.

Note:

Step 1: Joint distances, spacing and edge distances must be considered.

Step 2a + 2b: For further details on screwing in, see brick type related Annex C2 – C21.
The tightening torque must not exceed $T_{inst,max}$

Step 3a + 3b: It must not be possible to turn the screw. $T_{inst,max}$ must not be exceeded during the check.

TOX screw anchor Sumo Max 1 A4

Intended use
Installation Instructions

Annex B5

Installation Instructions - Adjustment

1. Adjustment

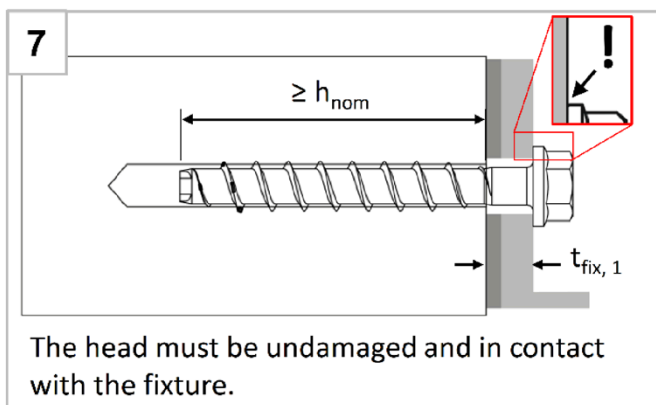
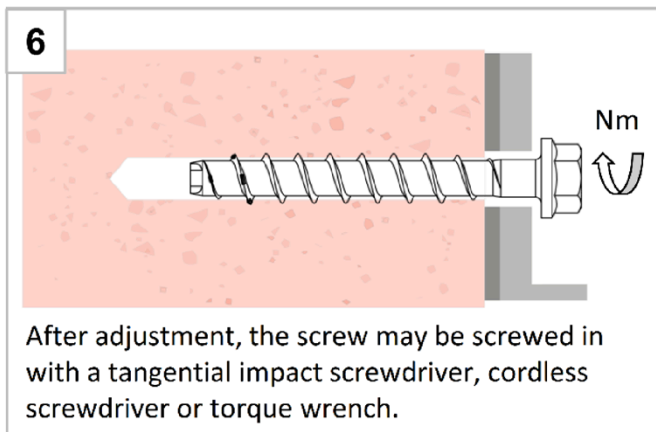
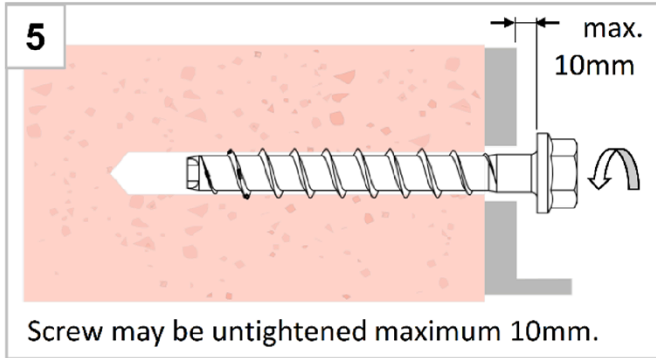

2. Adjustment

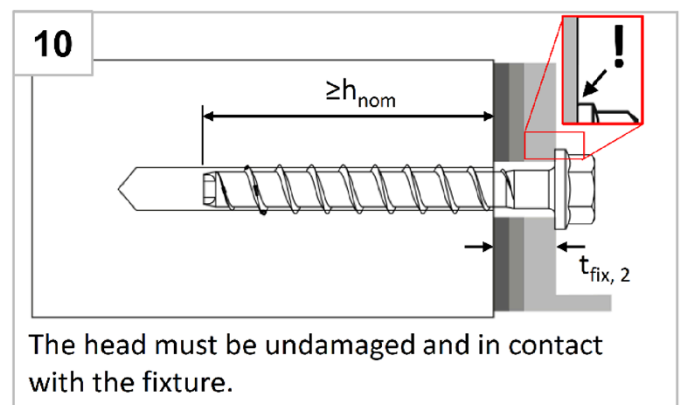
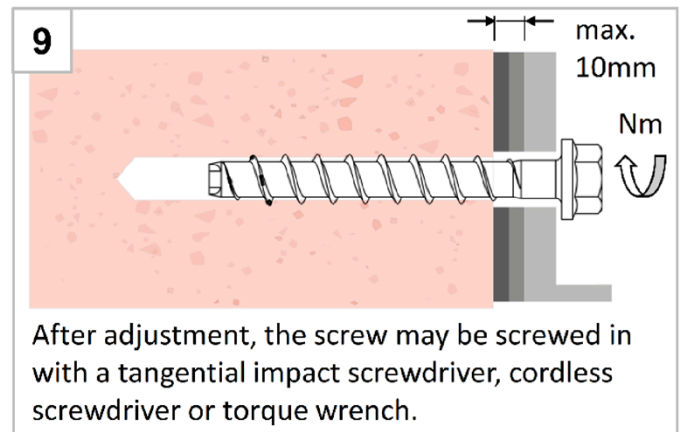
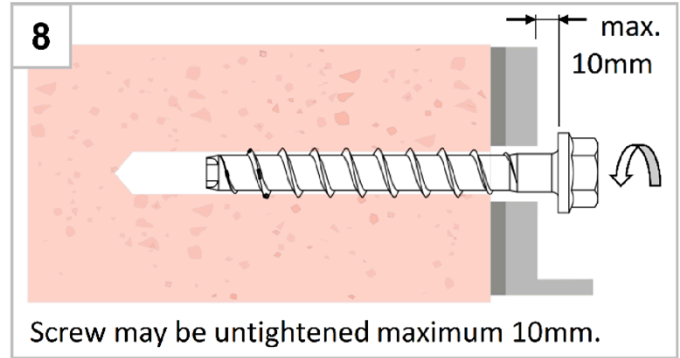

Note:

1. The screw can be adjusted maximum two times. The total allowed thickness of shims added during the adjustment process is 10mm. The final embedment depth after adjustment process must be larger or equal than h_{nom} .
2. For further details on screwing in, see brick type-related annexes C2 – C21

TOX screw anchor Sumo Max 1 A4

Intended use
Installation instruction – adjustment

Annex B6

Possible installation positions, the distance c_j must be observed

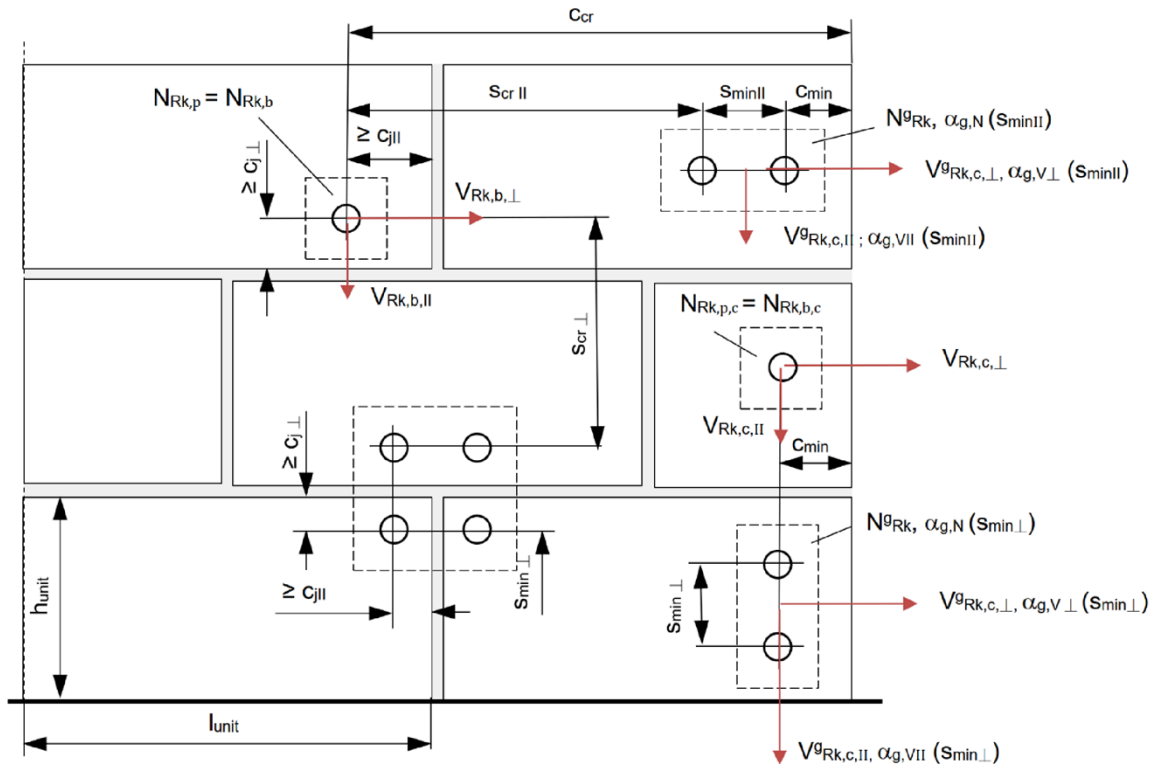

- c_{min} = minimum edge distance to the free edge of the wall
- $c_{j \parallel}$ = distance to the vertical joints without influence on resistance of the screw anchor
- $c_{j \perp}$ = distance to the horizontal joints without influence on resistance of the screw anchor
- $s_{min \parallel}$ = minimum spacing parallel to horizontal joint
- $s_{min \perp}$ = minimum spacing perpendicular to the horizontal joint
- s_{cr} = edge distance for transmission of the characteristic resistance of single screw anchor = $1,5h_{nom}$
- $s_{cr \parallel}$ = characteristic spacing parallel to the horizontal joint = $3,0h_{nom}$
- $s_{cr \perp}$ = characteristic spacing perpendicular to the horizontal joint = $3,0h_{nom}$
- l_{unit} = length of the masonry unit
- h_{unit} = height of the masonry unit
- $\alpha_{g,N} (s_{min \parallel})$ = group factor under tension load for minimum spacing parallel to horizontal joint
- $\alpha_{g,N} (s_{min \perp})$ = group factor under tension load for minimum spacing perpendicular to the horizontal joint
- $\alpha_{g,V \parallel}$ = group factor under shear load parallel to the edge ($\alpha_{g,V \parallel} = \alpha_{g,V \parallel} (s_{min \parallel}) = \alpha_{g,V \parallel} (s_{min \perp})$)
- $\alpha_{g,V \perp}$ = group factor under shear load perpendicular to the edge ($\alpha_{g,V \perp} = \alpha_{g,V \perp} (s_{min \parallel}) = \alpha_{g,V \perp} (s_{min \perp})$)

$$N_{RK} = N_{RK,b} = N_{RK,p} = N_{RK,b,c} = N_{RK,p,c}$$

$$V_{RK, \parallel} = V_{RK,b, \parallel} = V_{RK,c, \parallel}; V_{RK, \perp} = V_{RK,b, \perp} = V_{RK,c, \perp}$$

Für $s \geq s_{cr}$: $\alpha_{g,N} (s_{min \parallel}) = \alpha_{g,N} (s_{min \perp}) = \alpha_{g,V \parallel} = \alpha_{g,V \perp} = 2$

Für $s_{min} \leq s \leq s_{cr}$: $\alpha_{g,N} (s_{min \parallel})$; $\alpha_{g,N} (s_{min \perp})$; $\alpha_{g,V \parallel}$; $\alpha_{g,V \perp}$ according to installation parameters of brick in Annex C

$N_{RK}^{(s_{min \parallel})} = \alpha_{g,N} (s_{min \parallel}) \times N_{RK}$ (group of 2 anchors with minimum spacing parallel to horizontal joint)

$N_{RK}^{(s_{min \perp})} = \alpha_{g,N} (s_{min \perp}) \times N_{RK}$ (group of 2 anchors with minimum spacing perpendicular to horizontal joint)

$V_{RK, \parallel} = \alpha_{g,V \parallel} \times V_{RK, \parallel}$; $V_{RK, \perp} = \alpha_{g,V \perp} \times V_{RK, \perp}$ (group of 2 anchors)

$N_{RK} = \alpha_{g,N} (s_{min \parallel}) \times \alpha_{g,N} (s_{min \perp}) \times N_{RK}$ (group of 4 anchors)

$V_{RK, \parallel} = \alpha_{g,V \parallel}^2 \times V_{RK, \parallel}$; $V_{RK, \perp} = \alpha_{g,V \perp}^2 \times V_{RK, \perp}$ (group of 4 anchors)

TOX screw anchor Sumo Max 1 A4

Intended use
Possible installation position

Annex B7

Installations parameter for installation in the reveal site

Positioning in reveal in brick types KS NF, MZ NF

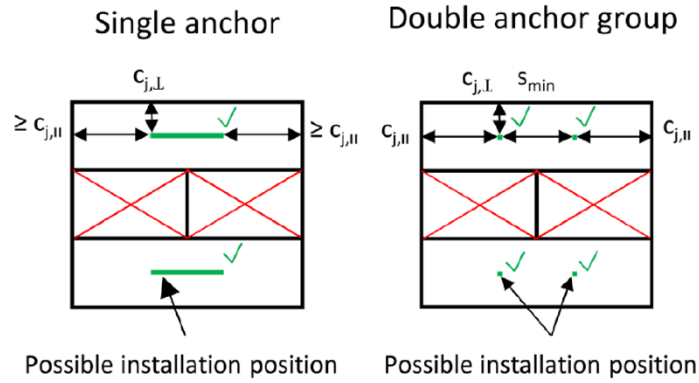

Positioning in reveal in brick type KSL 3DF

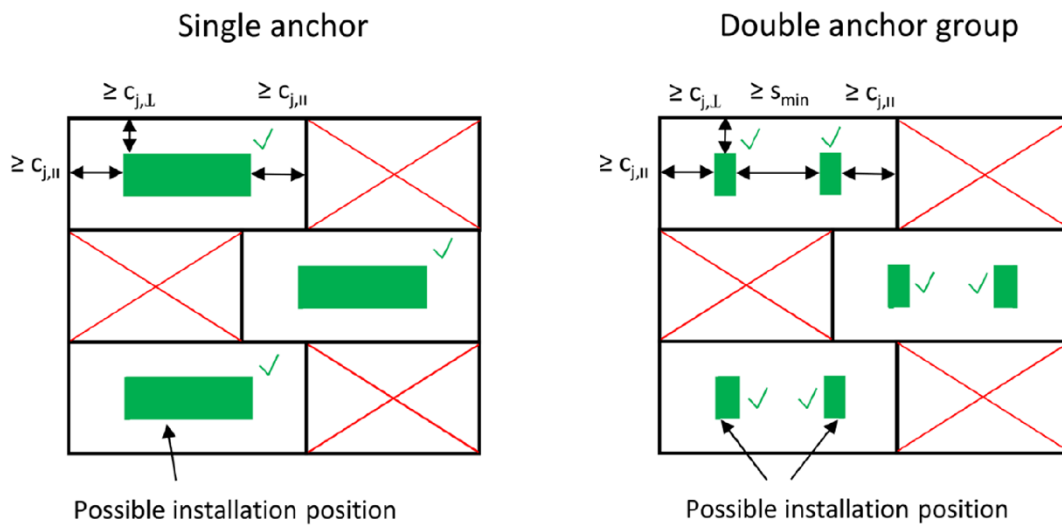

Top view

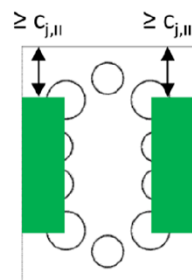

Top view

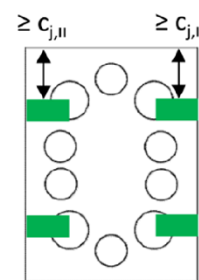

TOX screw anchor Sumo Max 1 A4

Intended use
Possible installation in reveal

Annex B8

Table 5: Characteristic resistance to steel failure

TSM screw size			6	8	10
Nominal embedment depth	h_{nom}		h_{nom1}	h_{nom1}	h_{nom1}
	[mm]		45	55	75
Steel failure for tension and shear loading					
Characteristic resistance under tension loading	$N_{Rk,s}$	[kN]	14,0	27,0	45,0
Partial factor	$\gamma_{Ms,N}^{1)}$	[-]	1,5		
Characteristic resistance under shear loading	$V_{Rk,s}$	[kN]	7,0	13,5	34,0
Partial factor	$\gamma_{Ms,V}^{1)}$	[-]	1,25		
Ductility factor	k_7	[-]	0,8		
Characteristic bending moment	$M^0_{Rk,s}$	[Nm]	10,9	26,0	56,0

1) In absence of other national regulations

TOX screw anchor Sumo Max 1 A4

Performance
Characteristic resistance to steel failure

Annex C1

Table 6: Material characteristics solid calcium silicate brick KS

	Solid calcium silicate brick KS acc. to EN 771-2:2011+A1:2015			
	Nomenclature	Dimensions [mm]	Mean compressive strength [N/mm ²]	Bulk density [kg/dm ³]
KS 20 - 2,0 - NF	L: ≥ 240 B: ≥ 115 H: ≥ 71	26,0 ≤ f _{mean} ≤ 38,0	≥ 2,0	240

Table 7: Installation parameters solid calcium silicate brick KS

Use category (installation)			dry or wet		
TSM screw size			6	8	10
Nominal embedment depth		h _{nom}	h _{nom1}	h _{nom1}	h _{nom1}
		[mm]	45	55	75
Nominal drill hole diameter	d ₀	[mm]	6	8	10
Cutting diameter of drill bit	d _{cut} ≤	[mm]	6,40	8,45	10,45
Drill hole depth	h ₀ ≥	[mm]	55	65	85
Clearance hole diameter	d _f ≤	[mm]	8	12	14
Torque for manual installation	max. T _{inst}	[Nm]	11	24	41
Impact screw driver	T _{imp,max}	[Nm]	Max. torque according to the manufacturer's instructions		
			185	300	

Table 8: Min. edge distance, spacing, group factors

TSM screw size		6	8	10	
Nominal embedment depth		h _{nom}	h _{nom1}	h _{nom1}	
		[mm]	45	55	75
Min. edge distance	c _{min}	[mm]	80		
Min. spacing	s _{min,II} = s _{min,⊥}	[mm]	80		
Group factors	α _{g,N} (s _{min,⊥})	[-]	1,50	1,15	1,65
	α _{g,N} (s _{min,II})	[-]	1,80	1,15	1,20
	α _{g,N,II} (s _{min,⊥})/(s _{min,II})	[-]	1,55	1,55	1,05
	α _{g,N,⊥} (s _{min,⊥})/(s _{min,II})	[-]	1,50	1,75	1,75

TOX screw anchor Sumo Max 1 A4

Performance

Solid calcium silicate brick KS – material characteristics, installation parameters, min. edge distance and spacing, group

Annex C2

Table 9: Reduction factors depending on the distance to joints

TSM screw size			6	8	10
Distance to joints	$c_{j\perp}$	[mm]	≥ 35		
	$c_{j\parallel}$		≥ 80		
Reduction factor	$\alpha_{j, N}$	[-]	1 (full resistance)		
	$\alpha_{j, VII} = \alpha_{j, V\perp}$				
Distance to joints	$c_{j\perp}$	[mm]	< 35		
	$c_{j\parallel}$		< 80		
Reduction factor	$\alpha_{j, N}$	[-]	Screw must not be used		

TOX screw anchor Sumo Max 1 A4

Performance

Solid calcium silicate brick KS – installation parameters close to the joints

Annex C3

Tabelle 10: Characteristic resistance to pull-out failure or brick breakout failure of a single screw anchor under tension loading and to local brick failure and brick edge failure of a single screw anchor under shear loading

Use category (installation)		dry or wet		
TSM screw size		6	8	10
Nominal embedment depth	h_{nom}	h_{nom1}	h_{nom1}	h_{nom1}
	[mm]	45	55	75
Compressive strength f_{mean}	[N/mm ²]	≥ 26,0		
Characteristic resistance to tension load	N_{RK} [kN]	2,5	4,1	4,5
Characteristic resistance to shear load	$V_{RK,II}$ [kN]	5,3		7,7
	$V_{RK,I}$ [kN]	2,8	2,1	
Compressive strength f_{mean}	[N/mm ²]	≥ 30,0		
Characteristic resistance to tension load	N_{RK} [kN]	2,7	4,4	4,8
Characteristic resistance to shear load	$V_{RK,II}$ [kN]	5,7		8,3
	$V_{RK,I}$ [kN]	3,0	2,3	
Compressive strength f_{mean}	[N/mm ²]	≥ 35,0		
Characteristic resistance to tension load	N_{RK} [kN]	3,0	4,8	5,2
Characteristic resistance to shear load	$V_{RK,II}$ [kN]	6,1		8,9
	$V_{RK,I}$ [kN]	3,2	2,5	
Compressive strength f_{mean}	[N/mm ²]	≥ 38,0		
Characteristic resistance to tension load	N_{RK} [kN]	3,1	5,0	5,4
Characteristic resistance to shear load	$V_{RK,II}$ [kN]	6,4		9,3
	$V_{RK,I}$ [kN]	3,4	2,6	

TOX screw anchor Sumo Max 1 A4

Performance

Solid calcium silicate brick KS – characteristic resistances

Annex C4

Table 11: Displacements

Use category (installation)			dry or wet		
TSM screw size			6	8	10
Nominal embedment depth	h_{nom}	[mm]	h_{nom1}	h_{nom1}	h_{nom1}
			45	55	75
Tension load	F_N	[kN]	0,6	1,1	1,1
Displacement in tension direction	δ_{N0}	[mm]	0,01		
	$\delta_{N\infty}$	[mm]	0,02		
Shear load parallel to the edge	$F_{V,II}$	[kN]	1,5		2,2
Displacement in shear direction parallel to the edge	$\delta_{V0,II}$	[mm]	0,76		0,37
	$\delta_{V\infty,II}$	[mm]	1,14		0,57
Shear load perpendicular to the edge	$F_{V,\perp}$	[kN]	0,8	0,6	
Displacement in shear direction perpendicular to the edge	$\delta_{V0,\perp}$	[mm]	0,57	0,31	0,01
	$\delta_{V\infty,\perp}$	[mm]	0,85	0,47	0,02

Table 12: Performance under fire exposure for anchor groups- resistance to fire

TSM screw size			6	8	10
Nominal embedment depth	h_{nom}	[mm]	45	55	75
Characteristic resistance to local brick failure of groups under fire exposure					
$N_{Rk,fi} = \text{factor} \times N_{Rk}^e$	[kN]	R30-R90	$0,12 \cdot N_{Rk}^e$	$0,14 \cdot N_{Rk}^e$	$0,24 \cdot N_{Rk}^e$
		R120	$0,10 \cdot N_{Rk}^e$	$0,11 \cdot N_{Rk}^e$	$0,19 \cdot N_{Rk}^e$
Min. edge distance and spacing	[mm]	$C_{min,fi} = C_{j,fi}$	$2 \times h_{nom}^{1)}$		
		$S_{min,fi}$	$4 \times h_{nom}$		

¹⁾ At least the distances set out in Table 13 shall be observed

TOX screw anchor Sumo Max 1 A4

Performance

Solid calcium silicate brick KS – displacements and performance under fire exposure for anchor groups

Annex C5

Table 13: Fire exposure – resistance to fire

TSM screw size				6	8	10
Nominal embedment depth		h_{nom}		h_{nom1}	h_{nom1}	h_{nom1}
		[mm]		45	55	75
Steel failure for tension and shear load						
Characteristic resistance	R30	$N_{Rk,s,fi30}$	[kN]	1,30		3,40
	R60	$N_{Rk,s,fi60}$	[kN]	1,00		2,70
	R90	$N_{Rk,s,fi90}$	[kN]	0,60		2,00
	R120	$N_{Rk,s,fi120}$	[kN]	0,50		1,70
	R30	$V_{Rk,s,fi30}$	[kN]	1,30		3,40
	R60	$V_{Rk,s,fi60}$	[kN]	1,00		2,70
	R90	$V_{Rk,s,fi90}$	[kN]	0,60		2,00
	R120	$V_{Rk,s,fi120}$	[kN]	0,50		1,70
	R30	$M^0_{Rk,s,fi30}$	[Nm]	1,10	1,50	4,90
	R60	$M^0_{Rk,s,fi60}$	[Nm]	0,80	1,10	4,00
	R90	$M^0_{Rk,s,fi90}$	[Nm]	0,50	0,80	3,00
	R120	$M^0_{Rk,s,fi120}$	[Nm]	0,40	0,60	2,50
Pull-out failure						
Characteristic resistance	R30	$N_{Rk,p,fi30}$	[kN]	1,30		3,40
	R60	$N_{Rk,p,fi60}$	[kN]	1,00		2,70
	R90	$N_{Rk,p,fi90}$	[kN]	0,60		2,00
	R120	$N_{Rk,p,fi120}$	[kN]	0,50		1,70
Breakout failure						
Characteristic resistance	R30	$N_{Rk,b,fi30}$	[kN]	1,30		3,40
	R60	$N_{Rk,b,fi60}$	[kN]	1,00		2,70
	R90	$N_{Rk,b,fi90}$	[kN]	0,60		2,00
	R120	$N_{Rk,b,fi120}$	[kN]	0,50		1,70
Edge and joint distance						
R30 - R120		$c_{min,fi} =$ $c_{j,fi,II}$	[mm]	120		
		$c_{j,fi,I}$	[mm]	35		
Spacing						
R30 - R120		$s_{min,fi}$	[mm]	4 x h_{nom}		
TOX screw anchor Sumo Max 1 A4						Annex C6
Performance Solid calcium silicate brick KS – resistance to fire						

Table 14: Material characteristics Silka XL solid calcium silicate brick KS 12DF

	Silka XL solid calcium silicate brick KS 12DF acc. to EN 771-2:2011+A1:2015				
	Nomenclature	Dimensions [mm]	Mean compressive strength [N/mm ²]	Bulk density [kg/dm ³]	Min. wall thickness h _{min} [mm]
	KS - R (P) 20 - 2,0 - 12DF	L: ≥ 498 B: ≥ 175 H: ≥ 248	14,0 ≤ f _{mean} ≤ 38,0	≥ 1,8	175

Table 15: Installation parameters Silka XL solid calcium silicate brick KS 12DF

Use category (installation)		dry or wet		
TSM screw size		6	8	10
Nominal embedment depth	h _{nom}	h _{nom1}	h _{nom1}	h _{nom1}
	[mm]	45	55	75
Nominal drill hole diameter	d ₀ [mm]	6	8	10
Cutting diameter of drill bit	d _{cut} ≤ [mm]	6,40	8,45	10,45
Drill hole depth	h ₀ ≥ [mm]	55	65	85
Clearance hole diameter	d _f ≤ [mm]	8	12	14
Torque for manual installation	max. T _{inst} [Nm]	11	25	41
Torque for rotary screwdriver installation	T _{imp,max} [Nm]	10	No performance assessed	
Impact screw driver	T _{imp,max} [Nm]	Max. torque according to the manufacturer's instructions		
		185	300	

TOX screw anchor Sumo Max 1 A4

Performance

Silka XL solid calcium silicate brick KS 12DF – material characteristics, installation parameters

Annex C7

Table 16: Min edge distance, spacing, group factors

TSM screw size			6	8	10
Nominal embedment depth	h_{nom}	[mm]	h_{nom1}	h_{nom1}	h_{nom1}
			45	55	75
Min. edge distance	c_{min}	[mm]	80		
Min. spacing	$s_{min,II} = s_{min,I}$	[mm]	80		
Group factors	$\alpha_{g,N} (s_{min,I})$	[-]	1,65	1,55	1,60
	$\alpha_{g,N} (s_{min,II})$	[-]	1,30	1,80	1,40
	$\alpha_{g,V,II} (s_{min,I}) / (s_{min,II})$	[-]	2,00		1,90
	$\alpha_{g,V,I} (s_{min,I}) / (s_{min,II})$	[-]	2,00		1,40

Table 17: Reduction factors depending on the distance to joints

TSM screw size			6	8	10
Distance to joints	$c_{j \perp}$	[mm]	≥ 40		
	$c_{j II}$		≥ 80		
Reduction factor	$\alpha_{j,N}$	[-]	1 (full resistance)		
	$\alpha_{j,V,II} = \alpha_{j,V,I}$				
Distance to joints	$c_{j \perp}$	[mm]	< 40		
	$c_{j II}$		< 80		
Reduction factor	$\alpha_{j,N}$	[-]	Screw must not be used		

TOX screw anchor Sumo Max 1 A4

Performance

Silka XL solid calcium silicate brick KS 12DF – min. edge distance and spacing, group factors group factors and installation parameters close to the joints

Annex C8

Table 18: Characteristic resistance to pull-out failure or brick breakout failure of a single screw anchor under tension loading and to local brick failure and brick edge failure of a single screw anchor under shear loading

Use category (installation)		dry or wet		
TSM screw size		6	8	10
Nominal embedment depth	h_{nom}	h_{nom1}	h_{nom1}	h_{nom1}
	[mm]	45	55	75
Compressive strength f_{mean}	[N/mm ²]	≥ 14,0		
Characteristic resistance to tension load	N_{Rk} [kN]	2,3	7,1	6,4
Characteristic resistance to shear load	$V_{Rk,II}$ [kN]	3,2		12,8
	$V_{Rk,L}$ [kN]	3,6		5,9
Compressive strength f_{mean}	[N/mm ²]	≥ 15,0		
Characteristic resistance to tension load	N_{Rk} [kN]	2,4	7,4	6,9
Characteristic resistance to shear load	$V_{Rk,II}$ [kN]	3,3		13,3
	$V_{Rk,L}$ [kN]	3,7		6,1
Compressive strength f_{mean}	[N/mm ²]	≥ 20,0		
Characteristic resistance to tension load	N_{Rk} [kN]	2,8	8,5	8,0
Characteristic resistance to shear load	$V_{Rk,II}$ [kN]	3,8		15,3
	$V_{Rk,L}$ [kN]	4,3		7,0

TOX screw anchor Sumo Max 1 A4

Performance
Silka XL solid calcium silicate brick KS 12DF – characteristic resistances

Annex C9

Table 19: Displacements

Use category (installation)		dry or wet		
TSM screw size		6	8	10
Nominal embedment depth	h_{nom}	h_{nom1}	h_{nom1}	h_{nom1}
	[mm]	45	55	75
Tension load	F_N [kN]	0,7	2,2	1,8
Displacement in tension direction	δ_{N0} [mm]	0,01	0,02	0,01
	$\delta_{N\infty}$ [mm]	0,02	0,04	0,02
Shear load parallel to the edge	$F_{V,II}$ [kN]	0,9		3,7
Displacement in shear direction parallel to the edge	$\delta_{V0,II}$ [mm]	0,37		1,70
	$\delta_{V\infty,II}$ [mm]	0,55		2,55
Shear load perpendicular to the edge	$F_{V,I}$ [kN]	1,0		1,7
Displacement in shear direction perpendicular to the edge	$\delta_{V0,I}$ [mm]	0,40		1,50
	$\delta_{V\infty,I}$ [mm]	0,60		2,25

Table 20: Performance under fire exposure for anchor groups - resistance to fire

TSM screw size		6	
Nominal embedment depth	h_{nom} [mm]	45	
Characteristic resistance to local brick failure of groups under fire exposure			
$N_{Rk,fi} = \text{factor} \times N_{Rk}^e$	[kN]	R30-R90	$0,12 \cdot N_{Rk}^e$
		R120	$0,10 \cdot N_{Rk}^e$
Min. edge distance and spacing	[mm]	$C_{min,fi} = C_{j,fi}$	$2 \times h_{nom}^{1)}$
		$S_{min,fi}$	$4 \times h_{nom}$

¹⁾ At least the distances set out in Table 21 shall be observed

TOX screw anchor Sumo Max 1 A4

Performance

Silka XL solid calcium silicate brick KS 12DF – displacements and performance under fire exposure for anchor groups

Annex C10

Table 21: Fire exposure – resistance to fire

TSM screw size				6
Nominal embedment depth		h_{nom}		h_{nom1}
		[mm]		45
Steel failure for tension and shear load				
Characteristic resistance	R30	$N_{Rk,s,fi30}$	[kN]	1,50
	R60	$N_{Rk,s,fi60}$	[kN]	1,10
	R90	$N_{Rk,s,fi90}$	[kN]	0,60
	R120	$N_{Rk,s,fi120}$	[kN]	0,40
	R30	$V_{Rk,s,fi30}$	[kN]	1,50
	R60	$V_{Rk,s,fi60}$	[kN]	1,10
	R90	$V_{Rk,s,fi90}$	[kN]	0,60
	R120	$V_{Rk,s,fi120}$	[kN]	0,40
	R30	$M^0_{Rk,s,fi30}$	[Nm]	1,20
	R60	$M^0_{Rk,s,fi60}$	[Nm]	0,90
	R90	$M^0_{Rk,s,fi90}$	[Nm]	0,50
	R120	$M^0_{Rk,s,fi120}$	[Nm]	0,30
Pull-out failure				
Characteristic resistance	R30	$N_{Rk,p,fi30}$	[kN]	0,40
	R60	$N_{Rk,p,fi60}$	[kN]	0,40
	R90	$N_{Rk,p,fi90}$	[kN]	0,40
	R120	$N_{Rk,p,fi120}$	[kN]	0,32
Breakout failure				
Characteristic resistance	R30	$N_{Rk,b,fi30}$	[kN]	0,28
	R60	$N_{Rk,b,fi60}$	[kN]	0,28
	R90	$N_{Rk,b,fi90}$	[kN]	0,28
	R120	$N_{Rk,b,fi120}$	[kN]	0,23
Edge and joint distance				
R30 - R120	$c_{min,fi} =$ $c_{j,fi,II}$	[mm]		120
	$c_{j,fi,I}$	[mm]		35
Spacing				
R30 - R120	$s_{min,fi}$	[mm]		$4 \times h_{nom}$

TOX screw anchor Sumo Max 1 A4

Performance

Perforated calcium silicate brick KSL 3DF - resistance to fire

Annex C11

Table 22: Material characteristics perforated calcium silicate brick KSL 3DF

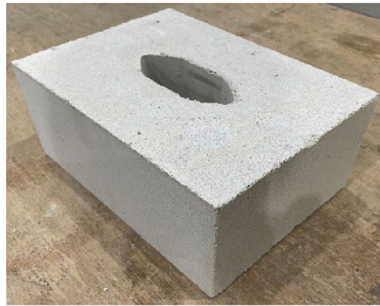

Perforated calcium silicate brick KSL 3DF acc. to EN 771-2:2011+A1:2015				
Nomenclature	Dimensions [mm]	Mean compressive strength [N/mm ²]	Bulk density [kg/dm ³]	Min. wall thickness h _{min} [mm]
SWKV KSL 12 - 1,6 - 3DF	L: ≥ 240 B: ≥ 175 H: ≥ 113	17,0 ≤ f _{mean} ≤ 29,0	≥ 1,5	175

Table 23: Installation parameters perforated calcium silicate brick KSL 3DF

Use category (installation)			dry or wet		
TSM screw size			6	8	10
Nominal embedment depth	h _{nom}	[mm]	h _{nom1}	h _{nom1}	h _{nom1}
			45	55	75
Nominal drill hole diameter	d ₀	[mm]	6	8	10
Cutting diameter of drill bit	d _{cut} ≤	[mm]	6,40	8,45	10,45
Drill hole depth	h ₀ ≥	[mm]	55	65	85
Clearance hole diameter	d _f ≤	[mm]	8	12	14
Torque for manual installation	max. T _{inst}	[Nm]	2	5	7
Torque for rotary screwdriver installation	T _{imp,max}	[Nm]	8	9	
Impact screw driver	T _{imp,max}	[Nm]	Max. torque according to the manufacturer's instructions		
			no performance assessed	200	

TOX screw anchor Sumo Max 1 A4

Performance

Perforated calcium silicate brick KSL 3DF- material characteristics, installation parameters

Annex C12

Table 24: Min. edge distance, spacing, group factors

TSM screw size			6	8	10
Nominal embedment depth	h_{nom}	[mm]	h_{nom1}	h_{nom1}	h_{nom1}
			45	55	75
Min. edge distance	C_{min}	[mm]	80		
Min. spacing	$S_{min,II} = S_{min,I}$	[mm]	80		
Group factors	$\alpha_{g,N} (S_{min,I})$	[-]	2,00	1,55	1,95
	$\alpha_{g,N} (S_{min,II})$	[-]	2,00	1,55	1,45
	$\alpha_{g,V,II} (S_{min,I}) / (S_{min,II})$	[-]	2,00		
	$\alpha_{g,V,I} (S_{min,I}) / (S_{min,II})$	[-]	1,80		1,30

Table 25: Reduction factors depending on the distance to joints

TSM screw size			6	8	10
Distance to joints	$C_{j \perp}$	[mm]	≥ 35		
	$C_{j \parallel}$		≥ 58		
Reduction factor	$\alpha_{j,N}$	[-]	1 (full resistance)		
	$\alpha_{j,V,II} = \alpha_{j,V,I}$				
Distance to joints	$C_{j \perp}$	[mm]	<35		
	$C_{j \parallel}$		<58		
Reduction factor	$\alpha_{j,N}$	[-]	Screw must not be used		

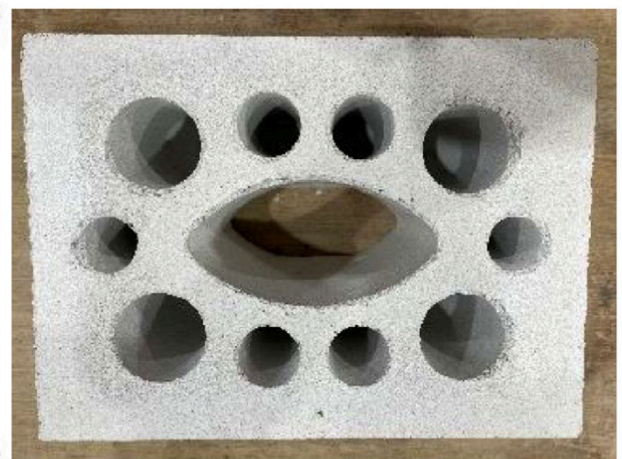
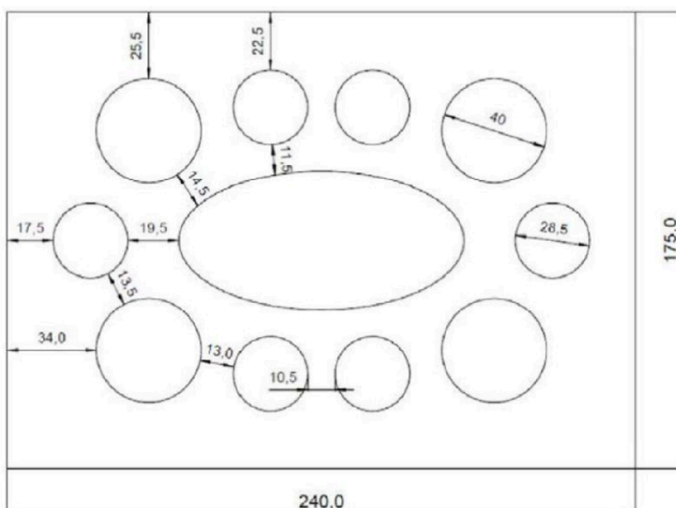

TOX screw anchor Sumo Max 1 A4

Performance

Perforated calcium silicate brick KSL 3DF – min. edge distance and spacing, group factors and installation parameters close to the

Annex C13

Table 26: Characteristic resistance to pull-out failure or brick breakout failure of a single screw anchor under tension loading and to local brick failure and brick edge failure of a single screw anchor under shear loading

Use category (installation)		dry or wet		
TSM screw size		6	8	10
Nominal embedment depth	h_{nom}	h_{nom1}	h_{nom1}	h_{nom1}
	[mm]	45	55	75
Compressive strength f_{mean}	[N/mm ²]	≥ 17,0		
Characteristic resistance to tension load	N_{Rk} [kN]	0,9	1,6	2,2
Characteristic resistance to shear load	$V_{Rk,II}$ [kN]	3,4		
	$V_{Rk,L}$ [kN]	1,6		2,2
Compressive strength f_{mean}	[N/mm ²]	≥ 20,0		
Characteristic resistance to tension load	N_{Rk} [kN]	0,9	1,8	2,5
Characteristic resistance to shear load	$V_{Rk,II}$ [kN]	3,8		
	$V_{Rk,L}$ [kN]	1,8		2,5
Compressive strength f_{mean}	[N/mm ²]	≥ 25,0		
Characteristic resistance to tension load	N_{Rk} [kN]	1,1	2,2	2,9
Characteristic resistance to shear load	$V_{Rk,II}$ [kN]	4,5		4,6
	$V_{Rk,L}$ [kN]	2,1		2,9
Interaction	X [-]	1,0		

TOX screw anchor Sumo Max 1 A4

Performance

Perforated calcium silicate brick KSL 3DF – characteristic resistances

Annex C14

Table 27: Displacements

Use category (Installation)		dry or wet		
TSM screw size		6	8	10
Nominal embedment depth	h_{nom}	h_{nom1}	h_{nom1}	h_{nom1}
	[mm]	45	55	75
Tension load	F_N [kN]	0,3	0,5	0,6
Displacement in tension direction	δ_{N0} [mm]	0,01		
	$\delta_{N\infty}$ [mm]	0,02		
Shear load parallel to the edge	$F_{V,II}$ [kN]	1,0		
Displacement in shear direction parallel to the edge	$\delta_{V0,II}$ [mm]	0,68	0,29	
	$\delta_{V\infty,II}$ [mm]	1,02	0,43	
Shear load perpendicular to the edge	$F_{V,\perp}$ [kN]	0,5	0,6	
Displacement in shear direction perpendicular to the edge	$\delta_{V0,\perp}$ [mm]	0,01		
	$\delta_{V\infty,\perp}$ [mm]	0,01		

Table 28: Performance under fire exposure for anchor groups - resistance to fire

TSM screw size		6	
Nominelle Einschraubtiefe	h_{nom} [mm]	45	
Characteristic resistance to local brick failure of groups under fire exposure			
$N_{Rk,fi} = \text{factor} \times N_{Rk}^e$	[kN]	R30-R90	$0,12 \cdot N_{Rk}^e$
		R120	$0,10 \cdot N_{Rk}^e$
Min. edge distance and spacing	[mm]	$c_{min,fi} = c_{j,fi}$	$2 \times h_{nom}^{1)}$
		$s_{min,fi}$	$4 \times h_{nom}$

¹⁾ At least the distances set out in Table 29 shall be observed

TOX screw anchor Sumo Max 1 A4

Performance

Perforated calcium silicate brick KSL 3DF – displacements and performance under fire exposure for anchor groups

Annex C15

Table 29: Fire exposure – resistance to fire

TSM screw size				6
Nominal embedment depth		h_{nom}		h_{nom1}
		[mm]		45
Steel failure for tension and shear load				
Characteristic resistance	R30	$N_{Rk,s,fi30}$	[kN]	1,0
	R60	$N_{Rk,s,fi60}$	[kN]	0,8
	R90	$N_{Rk,s,fi90}$	[kN]	0,5
	R120	$N_{Rk,s,fi120}$	[kN]	0,4
	R30	$V_{Rk,s,fi30}$	[kN]	1,0
	R60	$V_{Rk,s,fi60}$	[kN]	0,8
	R90	$V_{Rk,s,fi90}$	[kN]	0,5
	R120	$V_{Rk,s,fi120}$	[kN]	0,4
	R30	$M^0_{Rk,s,fi30}$	[Nm]	0,8
	R60	$M^0_{Rk,s,fi60}$	[Nm]	0,6
	R90	$M^0_{Rk,s,fi90}$	[Nm]	0,4
	R120	$M^0_{Rk,s,fi120}$	[Nm]	0,3
Pull-out failure				
Characteristic resistance	R30	$N_{Rk,p,fi30}$	[kN]	0,60
	R60	$N_{Rk,p,fi60}$	[kN]	0,40
	R90	$N_{Rk,p,fi90}$	[kN]	0,30
	R120	$N_{Rk,p,fi120}$	[kN]	0,20
Breakout failure				
Characteristic resistance	R30	$N_{Rk,b,fi30}$	[kN]	0,60
	R60	$N_{Rk,b,fi60}$	[kN]	0,40
	R90	$N_{Rk,b,fi90}$	[kN]	0,30
	R120	$N_{Rk,b,fi120}$	[kN]	0,20
Edge and joint distance				
R30 - R120	$c_{min,fi} = c_{j,fi,II}$	[mm]		101
	$c_{j,fi,I}$	[mm]		56
Spacing				
R30 - R120	$s_{min,fi}$	[mm]		$4 \times h_{nom}$
TOX screw anchor Sumo Max 1 A4				Annex C16
Performance Perforated calcium silicate brick KSL 3DF – resistance to fire				

Table 30: Material characteristic solid clay brick MZ



Solid clay brick MZ acc. to EN 771-1:2011+A1:2015				
Nomenclature	Dimensions [mm]	Mean compressive strength [N/mm ²]	Bulk density [kg/dm ³]	Min. wall thickness h _{min} [mm]
MZ 20 - 2,0 - NF	L: ≥ 240 B: ≥ 115 H: ≥ 71	21,0 ≤ f _{mean} ≤ 31,0	≥ 2,1	240

Table 31: Installation parameters solid clay brick MZ

Use category (installation)			dry or wet		
TSM screw size			6	8	10
Nominal embedment depth	h _{nom}	[mm]	h _{nom1}	h _{nom1}	h _{nom1}
			45	55	75
Nominal drill hole diameter	d ₀	[mm]	6	8	10
Cutting diameter of drill bit	d _{cut} ≤	[mm]	6,40	8,45	10,45
Drill hole depth	h ₀ ≥	[mm]	55	65	85
Clearance hole diameter	d _f ≤	[mm]	8	12	14
Torque for manual installation	max. T _{inst}	[Nm]	0,3	12	26
Torque for rotary screwdriver installation	T _{imp,max}	[Nm]	6	10	No performance assessed
Impact screw driver	T _{imp,max}	[Nm]	Max. torque according to the manufacturer's instructions		
			no performance assessed		155

TOX screw anchor Sumo Max 1 A4

Performance

Solid clay brick MZ – material characteristic, installation parameters

Annex C17

Table 32: Min. edge distance, spacing, group factors

TSM screw size			6	8	10
Nominal embedment depth	h_{nom}	[mm]	h_{nom1}	h_{nom1}	h_{nom1}
			45	55	75
Min. edge distance	c_{min}	[mm]	80		
Min. spacing	$s_{min,II} = s_{min,I}$	[mm]	80		
Group factors	$\alpha_{g,N} (s_{min,I})$	[-]	1,60	1,00	1,70
	$\alpha_{g,N} (s_{min,II})$	[-]	1,75	1,15	1,45
	$\alpha_{g,V,II} (s_{min,I}) / (s_{min,II})$	[-]	1,45		2,00
	$\alpha_{g,V,I} (s_{min,I}) / (s_{min,II})$	[-]	1,70		1,50

Table 33: Reduction factors depending on the distance to joints

TSM screw size			6	8	10
Distance to joints	$c_{j \perp}$	[mm]	≥ 35		
	$c_{j II}$		≥ 80		
Reduction factor	$\alpha_{j,N}$	[-]	1 (full resistance)		
	$\alpha_{j,V,II} = \alpha_{j,V,I}$				
Distance to joints	$c_{j \perp}$	[mm]	< 35		
	$c_{j II}$		< 80		
Reduction factor	$\alpha_{j,N}$	[-]	Screw must not be used		

TOX screw anchor Sumo Max 1 A4

Performance

Solid clay brick MZ – min. edge distance, spacing, group factors and installation parameters close to the joints

Annex C18

Table 34: Characteristic resistance to pull-out failure or brick breakout failure of a single screw anchor under tension loading and to local brick failure and brick edge failure of a single screw anchor under shear loading

Use category (installation)		dry or wet		
TSM screw size		6	8	10
Nominal embedment depth	h_{nom}	h_{nom1}	h_{nom1}	h_{nom1}
	[mm]	45	55	75
Compressive strength f_{mean}		[N/mm ²] $\geq 21,0$		
Characteristic resistance to tension load	N_{Rk} [kN]	1,4	2,2	2,8
Characteristic resistance to shear load	$V_{Rk,II}$ [kN]	2,5		2,6
	$V_{Rk,L}$ [kN]	1,9		2,1
Compressive strength f_{mean}		[N/mm ²] $\geq 25,0$		
Characteristic resistance to tension load	N_{Rk} [kN]	1,6	2,4	3,1
Characteristic resistance to shear load	$V_{Rk,II}$ [kN]	2,7		2,8
	$V_{Rk,L}$ [kN]	2,0		2,3
Compressive strength f_{mean}		[N/mm ²] $\geq 30,0$		
Characteristic resistance to tension load	N_{Rk} [kN]	1,7	2,7	3,4
Characteristic resistance to shear load	$V_{Rk,II}$ [kN]	2,9		3,1
	$V_{Rk,L}$ [kN]	2,2		2,5
Compressive strength f_{mean}		[N/mm ²] $\geq 31,0$		
Characteristic resistance to tension load	N_{Rk} [kN]	1,8	2,7	3,4
Characteristic resistance to shear load	$V_{Rk,II}$ [kN]	3,0		3,2
	$V_{Rk,L}$ [kN]	2,3		2,6

TOX screw anchor Sumo Max 1 A4

Performance
Solid clay brick MZ – characteristic resistances

Annex C19

Table 35: Displacements

Use category (installation)		dry or wet		
TSM screw size		6	8	10
Nominal embedment depth	h_{nom}	h_{nom1}	h_{nom1}	h_{nom1}
	[mm]	45	55	75
Tension load	F_N [kN]	0,4	0,6	0,8
Displacement in tension direction	δ_{N0} [mm]	0,01		
	$\delta_{N\infty}$ [mm]	0,02		
Shear load parallel to the edge	$F_{V,II}$ [kN]	0,7		0,7
Displacement in shear direction parallel to the edge	$\delta_{V0,II}$ [mm]	0,14		0,13
	$\delta_{V\infty,II}$ [mm]	0,22		0,20
Shear load perpendicular to the edge	$F_{V,\perp}$ [kN]	0,5		0,6
Displacement in shear direction perpendicular to the edge	$\delta_{V0,\perp}$ [mm]	0,34		0,33
	$\delta_{V\infty,\perp}$ [mm]	0,5		0,5

Table 36: Performance under fire exposure for anchor groups - resistance to fire

TSM screw size		6	8	10	
Nominal embedment depth	h_{nom} [mm]	45	55	75	
Characteristic resistance local brick failure of groups under fire exposure					
$N_{Rk,fi} = \text{factor} \times N_{Rk}^e$	[kN]	R30-R90	$0,12 \cdot N_{Rk}^e$	$0,14 \cdot N_{Rk}^e$	$0,24 \cdot N_{Rk}^e$
		R120	$0,10 \cdot N_{Rk}^e$	$0,11 \cdot N_{Rk}^e$	$0,19 \cdot N_{Rk}^e$
Min. edge distance and spacing	[mm]	$C_{min,fi} = C_{j,fi}$	$2 \times h_{nom}^{1)}$		
		$S_{min,fi}$	$4 \times h_{nom}$		

¹⁾ At least the distances set out in Table 37 shall be observed

TOX screw anchor Sumo Max 1 A4

Performance

Solid clay brick MZ – displacements and performance under fire exposure for anchor groups

Annex C20

Table 37: Fire exposure – resistance to fire

TSM screw size				6	8	10
Nominal embedment depth		h_{nom}		h_{nom1}	h_{nom1}	h_{nom1}
		[mm]		45	55	75
Steel failure for tension and shear load						
Characteristic resistance	R30	$N_{Rk,s,fi30}$	[kN]	1,30		1,70
	R60	$N_{Rk,s,fi60}$	[kN]	1,00		1,60
	R90	$N_{Rk,s,fi90}$	[kN]	0,60		1,60
	R120	$N_{Rk,s,fi120}$	[kN]	0,50		1,50
	R30	$V_{Rk,s,fi30}$	[kN]	1,30		1,70
	R60	$V_{Rk,s,fi60}$	[kN]	1,00		1,60
	R90	$V_{Rk,s,fi90}$	[kN]	0,60		1,60
	R120	$V_{Rk,s,fi120}$	[kN]	0,50		1,50
	R30	$M^0_{Rk,s,fi30}$	[Nm]	1,10	1,50	2,50
	R60	$M^0_{Rk,s,fi60}$	[Nm]	0,80	1,10	2,40
	R90	$M^0_{Rk,s,fi90}$	[Nm]	0,50	0,80	2,30
	R120	$M^0_{Rk,s,fi120}$	[Nm]	0,40	0,60	2,20
Pull-out failure						
Characteristic resistance	R30	$N_{Rk,p,fi30}$	[kN]	1,30		1,70
	R60	$N_{Rk,p,fi60}$	[kN]	1,00		1,60
	R90	$N_{Rk,p,fi90}$	[kN]	0,60		1,60
	R120	$N_{Rk,p,fi120}$	[kN]	0,50		1,50
Breakout failure						
Characteristic resistance	R30	$N_{Rk,b,fi30}$	[kN]	1,30		1,70
	R60	$N_{Rk,b,fi60}$	[kN]	1,00		1,60
	R90	$N_{Rk,b,fi90}$	[kN]	0,60		1,60
	R120	$N_{Rk,b,fi120}$	[kN]	0,50		1,50
Edge and joint distance						
R30 - R120	$c_{min,fi} = c_{j,fi,II}$	[mm]	120			
	$c_{j,fi,I}$	[mm]	35			
Spacing						
R30 - R120	$s_{min,fi}$	[mm]	$4 \times h_{nom}$			

TOX screw anchor Sumo Max 1 A4

Performance
Solid clay brick MZ – resistance to fire

Annex C21