

European Technical Approval ETA-06/0144

English translation prepared by DIBt - Original version in German language

Handelsbezeichnung
Trade name

Kenngott Hängetreppe
Kenngott Hanging Stair

Zulassungsinhaber
Holder of approval

Longlife - Treppen GmbH
Neulandstraße 31
74889 Sinsheim
DEUTSCHLAND

Zulassungsgegenstand
und Verwendungszweck

*Generic type and use
of construction product*

Fertigteiltreppe mit Trittstufen und tragendem Handlauf aus Massivholz
zur Verwendung als innenliegende Treppe in Gebäuden
*Prefabricated stair with steps and a load-bearing handrail made of solid
wood for use as an indoor stair in buildings*

Geltungsdauer:
Validity:

vom
from
bis
to

13 August 2009

verlängert
extended

vom
from
bis
to

28 June 2011

29 June 2011

29 June 2016

Herstellwerk
Manufacturing plant

Longlife - Treppen GmbH, Werk 1 und 2

Diese Zulassung umfasst
This Approval contains

15 Seiten einschließlich 7 Anhänge
15 pages including 7 annexes

I LEGAL BASES AND GENERAL CONDITIONS

- 1 This European technical approval is issued by Deutsches Institut für Bautechnik in accordance with:
 - Council Directive 89/106/EEC of 21 December 1988 on the approximation of laws, regulations and administrative provisions of Member States relating to construction products¹, modified by Council Directive 93/68/EEC² and Regulation (EC) N° 1882/2003 of the European Parliament and of the Council³;
 - Gesetz über das In-Verkehr-Bringen von und den freien Warenverkehr mit Bauprodukten zur Umsetzung der Richtlinie 89/106/EWG des Rates vom 21. Dezember 1988 zur Angleichung der Rechts- und Verwaltungsvorschriften der Mitgliedstaaten über Bauprodukte und anderer Rechtsakte der Europäischen Gemeinschaften (Bauproduktengesetz - BauPG) vom 28. April 1998⁴, as amended by law of 31 October 2006⁵;
 - Common Procedural Rules for Requesting, Preparing and the Granting of European technical approvals set out in the Annex to Commission Decision 94/23/EC⁶;
 - Guideline for European technical approval of "Prefabricated stair kits - Part 1: Prefabricated stair kits in general (excluding severe climatic conditions)", ETAG 008-01.
- 2 Deutsches Institut für Bautechnik is authorized to check whether the provisions of this European technical approval are met. Checking may take place in the manufacturing plant. Nevertheless, the responsibility for the conformity of the products to the European technical approval and for their fitness for the intended use remains with the holder of the European technical approval.
- 3 This European technical approval is not to be transferred to manufacturers or agents of manufacturers other than those indicated on page 1, or manufacturing plants other than those indicated on page 1 of this European technical approval.
- 4 This European technical approval may be withdrawn by Deutsches Institut für Bautechnik, in particular pursuant to information by the Commission according to Article 5(1) of Council Directive 89/106/EEC.
- 5 Reproduction of this European technical approval including transmission by electronic means shall be in full. However, partial reproduction can be made with the written consent of Deutsches Institut für Bautechnik. In this case partial reproduction has to be designated as such. Texts and drawings of advertising brochures shall not contradict or misuse the European technical approval.
- 6 The European technical approval is issued by the approval body in its official language. This version corresponds fully to the version circulated within EOTA. Translations into other languages have to be designated as such.

¹ Official Journal of the European Communities L 40, 11 February 1989, p. 12
² Official Journal of the European Communities L 220, 30 August 1993, p. 1
³ Official Journal of the European Union L 284, 31 October 2003, p. 25
⁴ *Bundesgesetzblatt Teil I 1998*, p. 812
⁵ *Bundesgesetzblatt Teil I 2006*, p. 2407, 2416
⁶ Official Journal of the European Communities L 17, 20 January 1994, p. 34

II SPECIFIC CONDITIONS OF THE EUROPEAN TECHNICAL APPROVAL

1 Definition of product and intended use

1.1 Definition of the construction product

The Kenngott Hanging Stair is a prefabricated stair (hereinafter referred to as stair), which consists of steps having a minimum thickness of 45 mm, a railing (consisting of handrail, posts and balusters), fasteners, load-bearing bolts and wall ties.

On the wall-free side the steps are connected with each other by a load-bearing bolt and via balusters with the load-bearing handrail. On the wall side each step is equipped with two wall ties which are anchored in the staircase wall. Alternatively, the staircase wall may also be replaced by a stringer or as on the wall-free side by a load-bearing handrail.

The steps, the handrail and the posts are made of solid wood, the balusters are made of steel or solid wood and the fasteners, load-bearing bolts and wall ties are made of steel.

Annex 1 shows the stair with its construction and its types of plan. According to the types of plan it is to be distinguished between stairs with straight flights, stairs with one quarter turn, with twice a quarter turn and with half a turn.

1.2 Intended use

The stair may be used as an indoor stair in buildings with air temperatures between +5 °C and +30 °C and relative air humidity between 30 % and 70 %.

The European technical approval covers a construction system. For the specific case of use the corresponding type of stair is manufactured within the context of the values defined in the European technical approval. The values apply to all types of stairs, the real dimensions follow in accordance with the relevant case of use.

The provisions made in this European technical approval are based on an assumed working life of the stair of 50 years; provided that the conditions laid down in sections 4 and 5 are met. The indications given on the working life cannot be interpreted as a guarantee given by the producer, but are to be regarded only as a means for choosing the right products in relation to the expected economically reasonable working life of the works.

2 Characteristics of the product and methods of verification

2.1 General

The stair corresponds to the drawings and data of the annexes. The material values, dimensions and tolerances of the components of the stair not indicated in the annexes shall correspond to the values laid down in the technical documentation⁷ of this ETA.

⁷ The technical documentation comprises all information of the holder of this ETA necessary for the production, installation and maintenance of the stair; these are in particular the structural analysis, design drawings and the manufacturer's installation instructions. The part to be treated confidentially is deposited with Deutsches Institut für Bautechnik and, as far as this is relevant to the tasks of the approved bodies involved in the procedure of attestation of conformity, shall be handed over to the approved body.

2.2 Mechanical resistance and stability

2.2.1 General

The stair has a sufficient mechanical resistance and stability in order to resist static or quasi-static loads.

The characteristic values of resistance of the stair given in Annex 7, Table 3 were determined from loading tests and by structural analysis. The structural analysis is an integral part of the technical documentation of this European technical approval.

2.2.2 Prevention of progressive collapse

Failure of individual components of the stair does not lead to a progressive collapse of the complete stair.

2.2.3 Residual load-bearing capacity

The stair loaded by service loads stated in Annex 7, Table 5 has a sufficient residual load-bearing capacity. A local material failure does not lead to an abrupt total loss of load-bearing capacity of the stair.

2.2.4 Long-term behaviour

The characteristic values of resistance stated in Annex 7, Table 3 are ensured under an appropriate use and maintenance over the indicated working life.

2.2.5 Resistance to earthquakes

No performance determined (NPD).

2.2.6 Load/displacement behaviour and vibration behaviour

The characteristic values concerning the load/displacement behaviour were determined by calculation and by testing. The values determined are given in Annex 7, Table 4.

The vibration behaviour was determined by calculation and by testing. The stair shows under a single load of $F = 1,0$ kN acting on the most unfavourable point at the wall-free side a deflection of $w \leq 5$ mm. The first natural frequency of the stair (inclusive a single mass of 100 kg) is greater than 5 Hz.

2.2.7 Resistance of the fixings

The characteristic loads which are passed on by the fasteners (wall ties and fixings for the posts at bottom and on the top) to the construction works are given in the technical documentation to European technical approval.

2.3 Safety in case of fire

2.3.1 Reaction to fire

The classification of the reaction to fire of the components of the stair is given in Annex 5, Table 1.

2.3.2 Fire resistance

No performance determined (NPD).

2.4 Hygiene, health and the environment

According to the manufacturer's declaration, taking account of the EU database⁸, the stair does not contain any dangerous substances.

In addition to the specific clauses relating to dangerous substances contained in this European technical approval, there may be other requirements applicable to the products falling within its scope (e.g. transposed European legislation and national laws, regulations and administrative provisions). In order to meet the provisions of the Construction Products Directive, these requirements need also to be complied with, when and where they apply.

⁸ Notes are stated in Guidance Paper H: "A harmonized approach relating to dangerous substances under the Construction Products Directive", Brussels, September 2002.

2.5 Safety in use

2.5.1 Geometry of the stair

The geometry of the stair is stated in Annex 6. The position of the constant pitch line / walking line is exemplified in Annex 1. The position of the walking line may be chosen freely within the walking zone. The walking zone is 20 % of the clear width of the stair and is located in the middle of the stair flight.

2.5.2 Slipperiness

No performance determined (NPD).

2.5.3 Equipment of the stair for a safe use

Barrier and handrail:

Barrier and handrail are components of the stair. The upper end of the barrier serves as handrail. Vertical balusters arranged between step and handrail are used as fill-in elements. Thereby a climb ability for infants will not be supported. An illustration and the dimensions of the barrier and handrail are given in Annex 6.

Tactility and visibility:

No performance determined (NPD).

2.5.4 Safe breakage of components

A brittle failure of individual components of the stair is excluded.

2.5.5 Impact resistance

No performance determined (NPD).

2.6 Durability and serviceability

2.6.1 Resistance to deterioration caused by physical, chemical and biological agents

Under an appropriate use and maintenance and at an indoor climate with air temperatures between +5°C and +30°C and relative air humidity between 30 % and 70 % the stair will have for the intended use an adequate resistance to

- physical agents like effects of temperature, radiation of sun and variations of relative humidity,
- chemical agents like effects of cleaning agents, water, carbon dioxide, oxygen and naturally occurring corrosives and pollution agents and
- biological agents like effects of fungi, bacteria, algae and insects.

2.6.2 Finishes and surface layers

The components made of solid wood (steps, handrail, posts and balusters) are coated with varnish on all sides or are lubricated.

3 Evaluation and attestation of conformity and CE marking

3.1 System of attestation of conformity

According to the Decision 99/89/EC of the European Commission⁹ the System 2+ of attestation of conformity applies.

In addition, according to the Decision 2001/596/EC of the European Commission¹⁰ the System 4 of attestation of conformity applies with regard to reaction to fire.

⁹ Official Journal of the European Communities L .29 of 03.02.1999

¹⁰ Official Journal of the European Communities L 209/33 of 02.08.2001

These systems of attestation of conformity are defined as follows:

System 2+: Declaration of conformity of the product by the manufacturer on the basis of:

(a) Tasks for the manufacturer:

- (1) initial type-testing of the product;
- (2) factory production control;
- (3) testing of samples taken at the factory in accordance with a prescribed control plan.

(b) Tasks for the approved body:

- (4) certification of factory production control on the basis of:
 - initial inspection of factory and of factory production control;
 - continuous surveillance, assessment and approval of factory production control.

System 4: Declaration of conformity of the product by the manufacturer on the basis of:

Tasks for the manufacturer:

- (1) initial type-testing of the product;
- (2) factory production control.

Note: Approved bodies are also referred to as "notified bodies".

3.2 Responsibilities

3.2.1 Tasks of the manufacturer

3.2.1.1 Factory production control

The manufacturer shall exercise permanent internal control of production. All the elements, requirements and provisions adopted by the manufacturer shall be documented in a systematic manner in the form of written policies and procedures, including records of results performed. This production control system shall insure that the product is in conformity with this European technical approval.

The manufacturer may only use initial materials and components stated in the technical documentation of this European technical approval.

The factory production control shall be in accordance with the control plan¹¹ which is part of the technical documentation of this European technical approval. The control plan is laid down in the context of the factory production control system operated by the manufacturer and deposited at Deutsches Institut für Bautechnik.

The results of factory production control shall be recorded and evaluated in accordance with the provisions of the control plan.

3.2.1.2 Other tasks of manufacturer

The manufacturer shall, on the basis of a contract, involve a body which is approved for the tasks referred to in section 3.1 in the field of stairs in order to undertake the actions laid down in section 3.2.2. For this purpose, the control plan referred to in sections 3.2.1.1 and 3.2.2 shall be handed over by the manufacturer to the approved body involved.

The manufacturer shall make a declaration of conformity, stating that the construction product is in conformity with the provisions of this European technical approval.

¹¹

The control plan is a confidential part of the European technical approval and only handed over to the approved body involved in the procedure of attestation of conformity. See section 3.2.2.

3.2.2 Tasks of approved bodies

The approved body shall perform the following tasks in accordance with the provisions laid down in the control plan:

- initial inspection of factory and of factory production control,
- continuous surveillance, assessment and approval of factory production control.

The approved body shall retain the essential points of its actions referred to above and state the results obtained and conclusions drawn in a written report.

The approved certification body involved by the manufacturer shall issue an EC certificate of conformity of the factory production control stating the conformity with the provisions of this European technical approval.

In cases where the provisions of the European technical approval and its control plan are no longer fulfilled the certification body shall withdraw the certificate of conformity and inform Deutsches Institut für Bautechnik without delay.

3.3 CE marking

The CE marking shall be affixed on a label attached to the stair or on the accompanying commercial documents (e.g. the EC declaration of conformity). The letters "CE" shall be followed by the identification number of the approved certification body, where relevant, and be accompanied by the following additional information:

- name or identifying mark and address of the producer of the stair (legal entity responsible for the manufacturer),
- identification of the stair (trade name),
- the last two digits of the year in which the CE marking was affixed,
- number of the EC certificate of conformity for the factory production control,
- number of the European technical approval,
- ETAG 008, Part 1.

If the CE marking is affixed on the accompanying commercial documents, the following minimum information shall be given on a label attached to the stair:

- initials "CE" followed by the identification number of the certification body,
- name or identifying mark of the manufacturer of the stair (legal entity responsible for the manufacturer),
- identification of the stair (trade name),
- the last two digits of the year in which the CE marking was affixed.

4 Assumptions under which the fitness of the product for the intended use was favourably assessed

4.1 Manufacture

The European technical approval is issued for the product on the basis of agreed data/information, deposited with Deutsches Institut für Bautechnik, which identifies the product that has been assessed and judged. Changes to the product or production process, which could result in this deposited data/information being incorrect, should be notified to Deutsches Institut für Bautechnik before the changes are introduced.

Deutsches Institut für Bautechnik will decide whether or not such changes affect the approval and consequently the validity of the CE marking on the basis of the approval and if so whether further assessment or alterations to the approval shall be necessary.

4.2 Design

The fitness for use of the stair is given under the following assumptions:

The stair is designed according to the drawings and data of the annexes and the technical documentation to this European technical approval.

The stair is fixed to the construction works according to the drawings and data of the annexes and the technical documentation to this European technical approval. The proof of the transmission of loads in the construction works are made by the civil engineer responsible for the construction works.

The load-bearing capacity of the stair at ultimate limit state is verified according to Annex 7, Table 3. The load-bearing capacity of the stair at serviceability limit state is verified according to Annex 7, Table 4.

4.3 Installation

The fitness for use of the stair can be assumed only, if the following installation conditions are adhered to:

- installation by personnel appropriately trained and authorized by the holder of the approval by means of the technical documentation of this European technical approval,
- installation only in the way as specified in the technical documentation of this European technical approval,
- installation of the timber components when moisture content of the timber components is $8 \pm 2 \%$,
- sufficient support of the stair when assembling,
- installation of parts of the stair without imposed deformations,
- installation of parts of the stair without significant defects and cracks,
- replacing of parts of the stair, which begin tearing when assembling,
- bolted connections are protected such that they will not be loosened by vibrations.

5 Indications to the manufacturer

5.1 Manufacturer's responsibilities

It is the manufacturer's responsibility to make sure that all persons involved will be appropriately informed about the specific conditions according to sections 1, 2, 4.2 and 4.3 including the annexes to which reference is being made as well as the not confidential parts of the technical documentation deposited to this European technical approval.

5.2 Recommendations regarding packaging, transport and storage

The components of wood and wood based products should be packed such that the wood moisture is $8 \pm 2 \%$ during transport and storage.

5.3 Recommendations regarding use, maintenance and repair

In his instructions for use the manufacturer should provide information as to use, maintenance and repair of the stair. At least the following information should be given:

- retighten the bolting of the load-bearing bolts and connections according to Annex 2 to 4 after the first heating season,
- no moisture penetration of the timber components.

Georg Feistel
Head of Department

beglaubigt.
Wittstock

Types of plan

Walking line exemplified, position may be chosen freely within the walking zone, walking zone is 20 % of the clear width of the stair in the middle of the stair

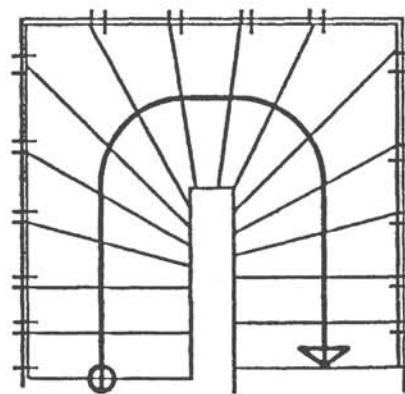
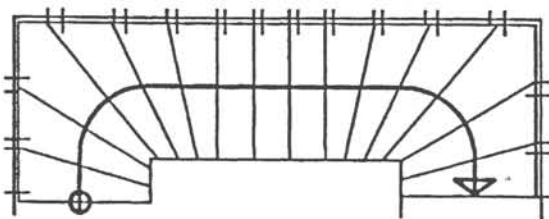
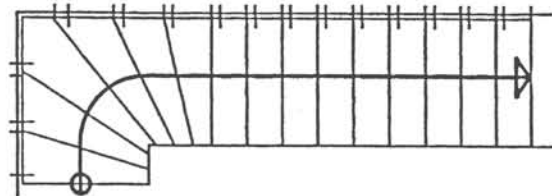
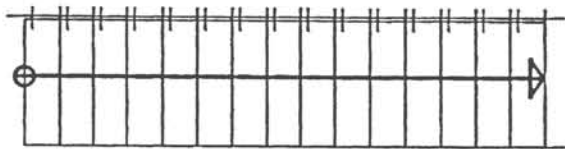

Types of construction

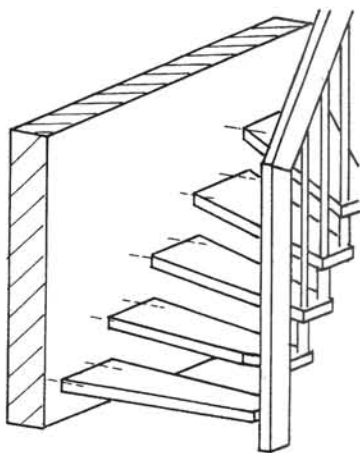

Length according
Annex 6

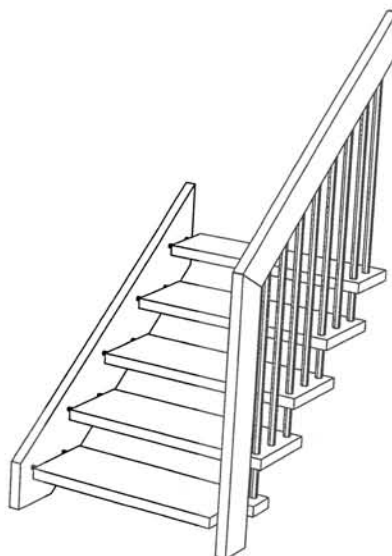

Length according Annex 6,
horizontal wall fastening according
to the technical documentation

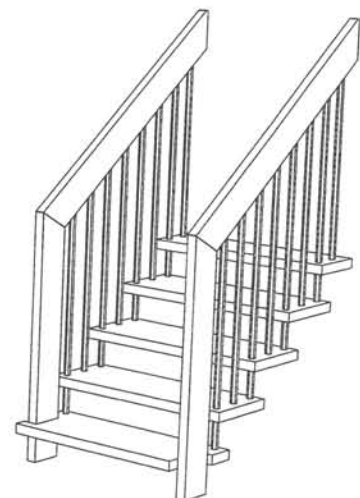

Length and horizontal wall
fastening according to the
technical documentation

Kenngott Hanging Stair

Product and intended use

Annex 1

System baluster

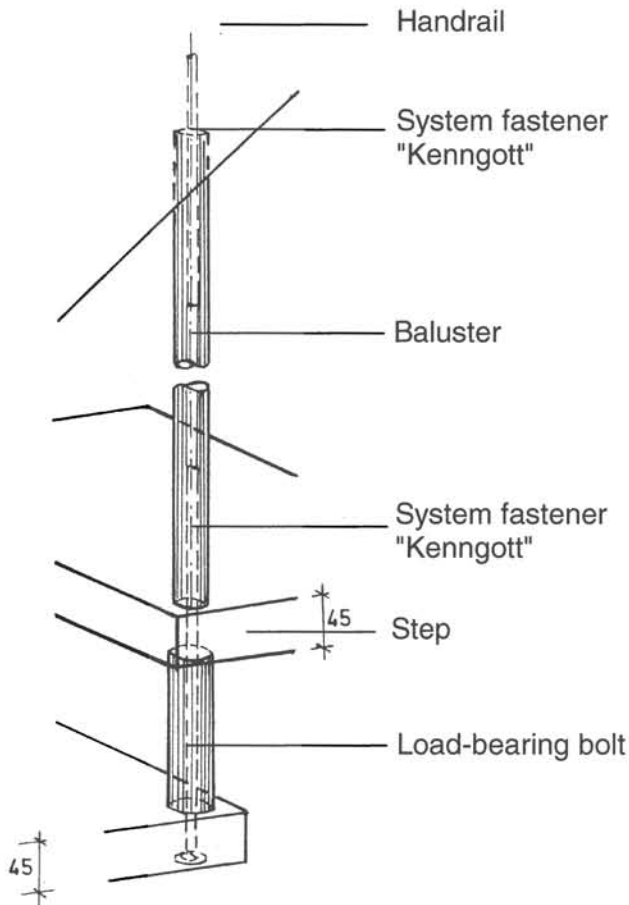

Fastener handrail

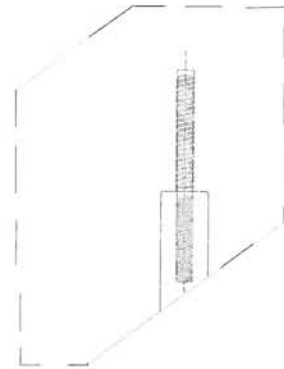

Fastener baluster

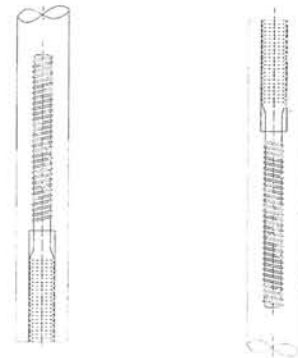

Load-bearing bolt between steps (possible types)

Load-bearing bolt SE V11

Load-bearing bolt steel

Load-bearing bolt wood

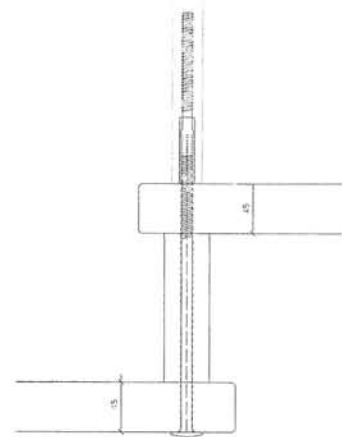
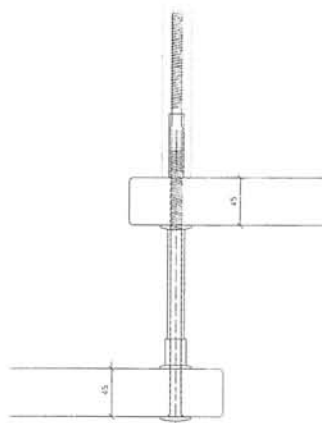
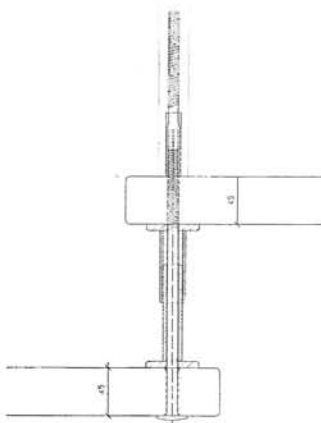

Kenngott Hanging Stair

System baluster, Fastener handrail and baluster,
Load-bearing bolts

Annex 2

Post – handrail joint (possible types)

finger jointed

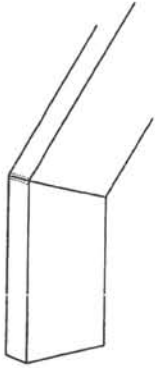

screwed

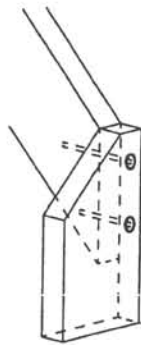

screwed

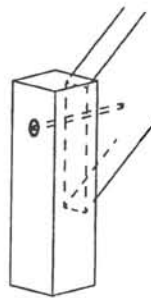

screwed

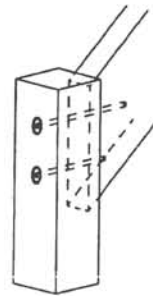

Handrail corner joint (possible types)

screwed

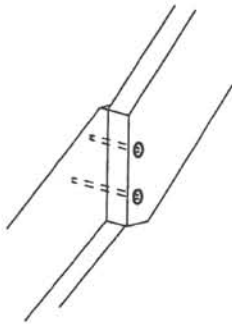

screwed

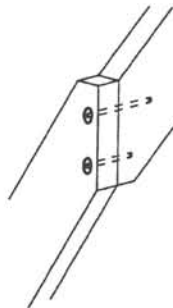

finger jointed

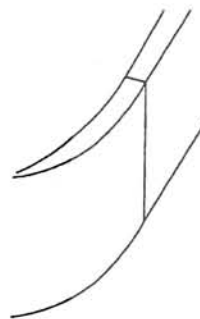

Wall tie (possible types)

Minimum wall thickness and minimum strength of the wall material as well as distances to the wall according to the technical documentation

Masonry

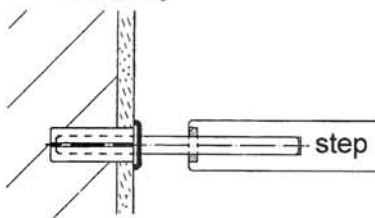

Concrete

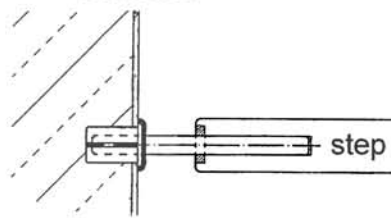

Particle board or OSB plate

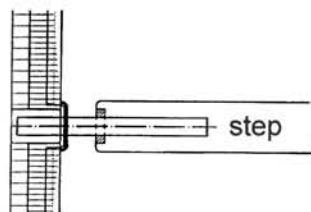

Stringer (solid wood)

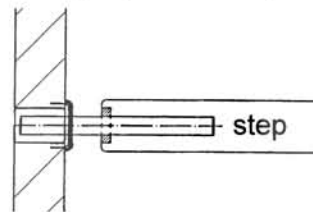

Kenngott Hanging Stair

Post - handrail joints, Handrail corner joints,
Wall ties

Annex 3

Post joint at bottom ¹⁾

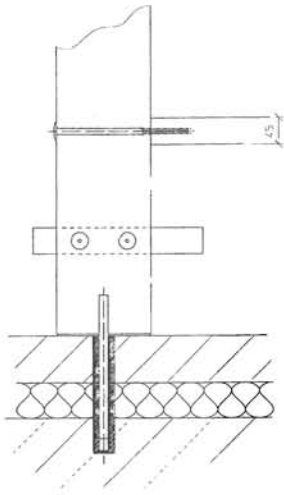

Post joint at the top ¹⁾

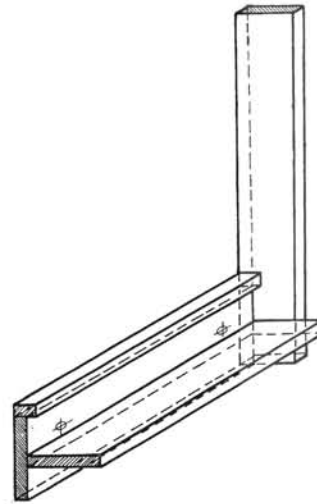

Post – step joint (possible types) ¹⁾

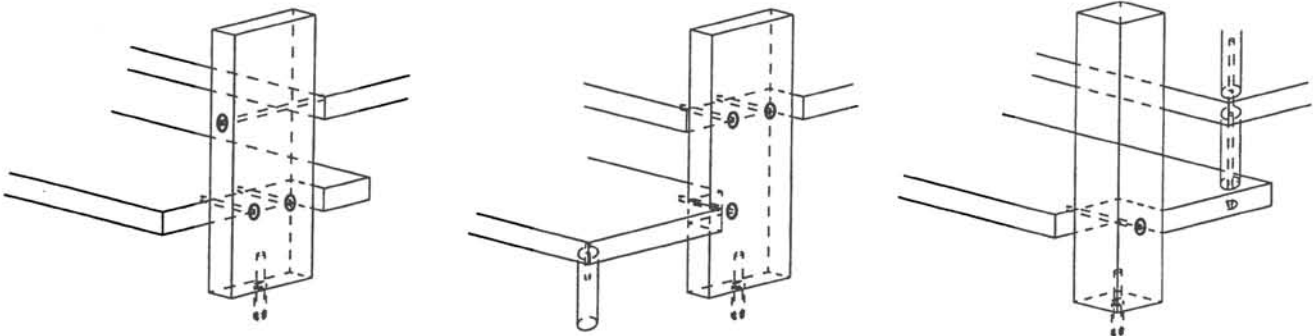

¹⁾ more details according to the technical documentation

Kenngott Hanging Stair

Post joint at bottom, Post joint at the top,
Post – step joint

Annex 4

Table 1: Components of stair: minimum dimensions and materials

Component of stair		Material ⁴⁾	Dimension		Value	Reaction to fire ⁵⁾
steps		solid wood ¹⁾	thickness	[mm]	45	D-s2, d0 (2003/593/EC)
upper flange of the railing / handrail	straight flights only finger jointed	solid wood ¹⁾	height / width	[mm]	160 / 53 (45) ²⁾	D-s2, d0 (2003/593/EC)
	other flights	solid wood ¹⁾	height / width	[mm]	160 / 45	
posts	straight flights only finger jointed	solid wood ¹⁾	cross section a/b	[mm]	160 / 53 (45) ²⁾	D-s2, d0 (2003/593/EC)
	other flights	solid wood ¹⁾	cross section a/b	[mm]	80 / 80 or 160 / 45	
			diameter	[mm]	90	
baluster	solid wood ¹⁾		diameter	[mm]	28	D-s2, d0 (2003/593/EC)
	steel		diameter	[mm]	18	A1 (96/603/EC)
load-bearing bolt / system fastener		steel	- ³⁾		- ³⁾	A1 (96/603/EC)
load-bearing bolt / distance sleeve		solid wood ¹⁾	diameter	[mm]	16 or SE V11	
		steel	diameter	[mm]	42	D-s2, d0 (2003/593/EC)
wall ties	round steel		diameter	[mm]	16	A1 (96/603/EC)
			embedment depth wall	[mm]	60 (40) ⁶⁾	
			embedment depth step	[mm]	100	
bearing sleeve for wall tie		plastic	diameter	[mm]	40	not relevant
stringer		solid wood ¹⁾	thickness / height	[mm]	45 / 300	D-s2, d0 (2003/593/EC)

¹⁾ only hardwood of the following species: beech, oak, common ash, maple

²⁾ value in brackets if handrail is fixed in height of the floor slab

³⁾ characteristic values according to the technical documentation

⁴⁾ characteristic values of materials according to the technical documentation

⁵⁾ according to the provisions of EC decisions

⁶⁾ masonry: embedment depth 60 mm,
concrete, particle board, OSB, stringer: embedment depth 40 mm

Kenngott Hanging Stair

Minimum dimensions of components of the stair
and reaction to fire

Annex 5

Table 2: Geometry

designation			dimension	
			minimum	maximum
going	step on walking line ¹⁾	[mm]	210	370 ²⁾
	tapered step	[mm]	60 ^{2) 3)}	600 ^{2) 4)}
rise of the stairs ¹⁾		[mm]	140 ²⁾	210
pitch of the walking line ¹⁾		[°]	21	45
overlap of the steps		[mm]	40	- ⁵⁾
number of rises		[-]	3	16
openings	between barrier and other parts of the stair	[mm]	0	0
	between stairs and wall	[mm]	- ⁵⁾	50
	between consecutive steps	[mm]	- ⁵⁾	165
	between balusters	[mm]	40	120
clear width of stairs		[mm]	500	1000
minimum headroom		[mm]	- ⁵⁾	
length of the flight		[mm]	- ⁵⁾	4050
thickness of steps		[mm]	45	- ⁵⁾
height of the railing (barrier) / handrail		[mm]	800	1200
thickness of the handrail		[mm]	45	53

¹⁾ values are constant within one flight

²⁾ tolerance between nominal value and actual value = ± 5 mm

³⁾ inside of tapered step

⁴⁾ outside of tapered step

⁵⁾ not relevant

- 1 going
- 2 rise
- 3 overlap
- 4 opening between consecutive steps
- 5 length of the flight
- 6 thickness of steps
- 7 height of the railing / barrier
- 8 opening between balusters

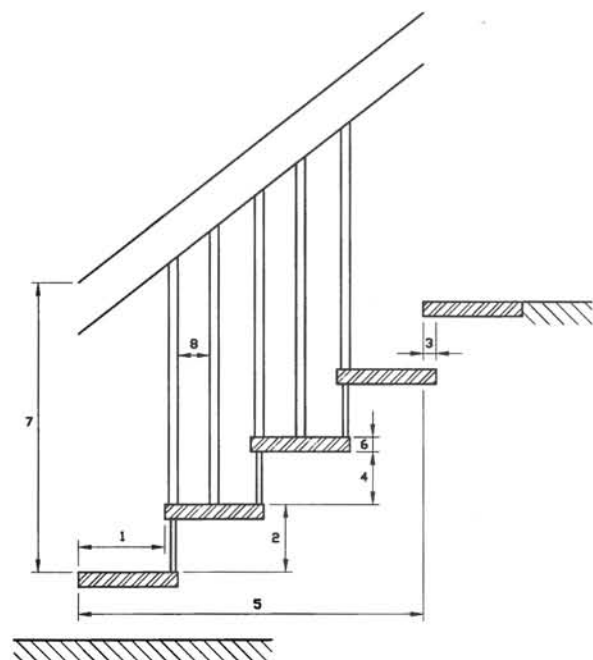

Kenngott Hanging Stair

Geometry of the stair

Annex 6

Table 3: Load-bearing capacity at ultimate limit state ¹⁾ - Characteristic values of resistance R_k

Type of loading	Characteristic values of resistance			γ_M ²⁾
vertical variable uniformly distributed load	q_{Rk}	[kN/m ²]	10.5	1.5
vertical variable single load	Q_{Rk}	[kN]	4.5	
horizontal variable uniformly distributed load	h_{Rk}	[kN/m]	1.5	

¹⁾ Proof of ultimate limit state is only given if the design value of the actions does not exceed the design value of the resistance: $F_d \leq R_d$ with $F_d = F_k \cdot \gamma_F$ and $R_d = R_k / \gamma_M$

R_k and γ_M according to Table 3

F_k = characteristic values of actions (imposed loads according to EN 1991-1-1)

$\gamma_F = 1.5$ (recommended partial safety factor, in absence of other national regulations)

²⁾ Recommended partial safety factor in absence of other national regulations

Table 4: Load-bearing capacity at Serviceability limit state ¹⁾ - Deflections under loading

Deflection of the flight under uniformly distributed load			
load F_S	$q_S =$	3.5	[kN/m ²]
length of the median line of the flight	$l =$	4050	[mm]
deflection under load F_S related to the median line of the flight	$w \leq$	$l/200$	[-]
Deflection of the step under single point load			
load F_S	$Q_S =$	2.0	[kN]
clear width of the stair	$l =$	1000	[mm]
deflection under load F_S related to the clear width of the stair	$w \leq$	$l/200$	[-]

¹⁾ Proof of serviceability limit state is only given if the characteristic value of the actions (imposed loads according to EN 1991-1-1) does not exceed the value F_S according to Table 4: $F_k \leq F_S$

Table 5: Load-bearing capacity - Service loads ¹⁾

Minimum value from proof of ultimate limit state and serviceability limit state			
vertical variable uniformly distributed load	q	[kN/m ²]	3.5
vertical variable single load	Q	[kN]	2.0
horizontal variable uniformly distributed load	h	[kN/m]	0.5

¹⁾ Service load = $\min (R_k / (\gamma_M \cdot \gamma_F); F_S)$ with R_k , γ_M , γ_F according to Table 3 and F_S according to Table 4

Kenngott Hanging Stair

Load-bearing capacity at ultimate limit state,
Load-bearing capacity at serviceability limit state,
Load-bearing capacity – service loads

Annex 7