

Approval body for construction products
and types of construction

Bautechnisches Prüfamt

An institution established by the Federal and
Laender Governments



European Technical Assessment

ETA-06/0154
of 10 August 2017

English translation prepared by DIBt - Original version in German language

General Part

Technical Assessment Body issuing the
European Technical Assessment:

Deutsches Institut für Bautechnik

Trade name of the construction product

"System Krieger" Stair

Product family
to which the construction product belongs

Prefabricated stair with steps and a load-bearing handrail
made of solid wood for use as an indoor stair in buildings

Manufacturer

Treppenbau
"System Krieger" GmbH
Gewerbegebiet Wolf
56841 Traben-Trarbach
DEUTSCHLAND

Manufacturing plant

Krieger Treppen GmbH Werk 1 bis 99

This European Technical Assessment
contains

14 pages including 3 annexes which form an integral part
of this assessment

This European Technical Assessment is
issued in accordance with Regulation (EU)
No 305/2011, on the basis of

European Assessment Document (EAD)
340006-00-0506

This version replaces

ETA-06/0154 issued on 24 November 2016

The European Technical Assessment is issued by the Technical Assessment Body in its official language. Translations of this European Technical Assessment in other languages shall fully correspond to the original issued document and shall be identified as such.

Communication of this European Technical Assessment, including transmission by electronic means, shall be in full. However, partial reproduction may only be made with the written consent of the issuing Technical Assessment Body. Any partial reproduction shall be identified as such.

This European Technical Assessment may be withdrawn by the issuing Technical Assessment Body, in particular pursuant to information by the Commission in accordance with Article 25(3) of Regulation (EU) No 305/2011.

Specific Part

1 Technical description of the product

The "System Krieger" Stair is a prefabricated stair system, which consists of steps, landings, a railing (consisting of handrail, posts and balusters), fasteners, load-bearing bolts and wall ties. The stair can also be formed as a folded plate stair by additional risers.

On the wall-free side the steps are connected with each other by a load-bearing bolt and via balusters with the load-bearing handrail. On the wall side each step is equipped with two wall ties which are anchored in the staircase wall. Alternatively, the staircase wall may also be replaced by a stringer or as on the wall-free side by a load-bearing handrail.

Steps, landings, handrail and posts are made of solid wood, the balusters and the beams of landings are made of steel or solid wood and the fasteners, load-bearing bolts and wall ties are made of steel.

The product description is given in Annex A. The material values, dimensions and tolerances of the components of the stair not indicated in the annexes shall correspond to the values laid down in the technical documentation¹.

2 Specification of the intended use in accordance with the applicable European Assessment Document

The performances given in Section 3 are only valid if the stair is used in compliance with the specifications and conditions given in Annex B.

The verification and assessment methods on which this European Technical Assessment is based lead to the assumption of a working life of the stair of at least 50 years. The indications given on the working life cannot be interpreted as a guarantee given by the producer, but are to be regarded only as a means for choosing the right products in relation to the expected economically reasonable working life of the works.

¹ The technical documentation comprises all information of the holder of this ETA necessary for the production, installation and maintenance of the stair; these are in particular the structural analysis, design drawings and the manufacturer's installation instructions. The part to be treated confidentially is deposited with Deutsches Institut für Bautechnik and, as far as this is relevant to the tasks of the approved bodies involved in the procedure of attestation of conformity, shall be handed over to the approved body.

3 Performance of the product and references to the methods used for its assessment

3.1 Mechanical resistance and stability (BWR 1)

Essential characteristic	Performance
Load-bearing capacity of stair	See Annex C2
Load-bearing capacity of fixings	See technical documentation of this European Technical Assessment
Load/displacement behaviour	See Annex C2
Vibration behaviour	First natural frequency: $f_1 \geq 5$ Hz (inclusive a single mass of 100 kg) Deflection under a single load $F = 1$ kN: $w \leq 5$ mm
Prevention of progressive collapse	Failure of individual components of the stair does not lead to a progressive collapse of the complete stair
Residual load-bearing capacity	Local material failure does not lead to an abrupt total loss of load-bearing capacity of the steps.
Long-term behaviour	Load-bearing capacity are ensured under an appropriate use and maintenance over the indicated working life
Resistance to earthquakes	No performance assessed
Durability against physical, chemical and biological agents	Adequate durability for the intended use under an appropriate use and maintenance

3.2 Safety in case of fire (BWR 2)

Essential characteristic	Performance
Reaction to fire	See Annex A5
Fire resistance	No performance assessed

3.3 Hygiene, health and the environment (BWR 3)

Essential characteristic	Performance
Release of formaldehyde	Wood adhesive does not contain formaldehyde
Release of pentachlorophenol	No pentachlorophenol treated materials are used
Radioactive emission	Not relevant

3.4 Safety in use (BWR 4)

Essential characteristic	Performance
Geometry	See Annex C1
Slipperiness	No performance assessed
Equipment of the stair for a safe use	Barrier and handrail are components of the stair (see Annexes A2 to A3 and C1) If vertical balusters, arranged between step and handrail, used as fill-in elements, a climb ability for infants will not be supported Tactility and visibility: No performance assessed
Safe breakage of components	No brittle failure of individual components
Impact resistance	No performance assessed

4 Assessment and verification of constancy of performance (AVCP) system applied, with reference to its legal base

In accordance with the European Assessment Document EAD No. 340006-00-0506 the applicable European legal act is: 1999/89/EC

The System to be applied is: 2+

In addition, with regard to reaction to fire for products covered by the European Assessment Document EAD No. 340006-00-0506 the applicable European legal act is: 2001/596/EC

The System to be applied is: 4

5 Technical details necessary for the implementation of the AVCP system, as provided for in the applicable European Assessment Document

Technical details necessary for the implementation of the AVCP system are laid down in the control plan deposited at Deutsches Institut für Bautechnik.

Issued in Berlin on 10 August 2017 by Deutsches Institut für Bautechnik

BD Dipl.-Ing. Andreas Kummerow
Head of Department

beglaubigt:
Stiller

Types of plan

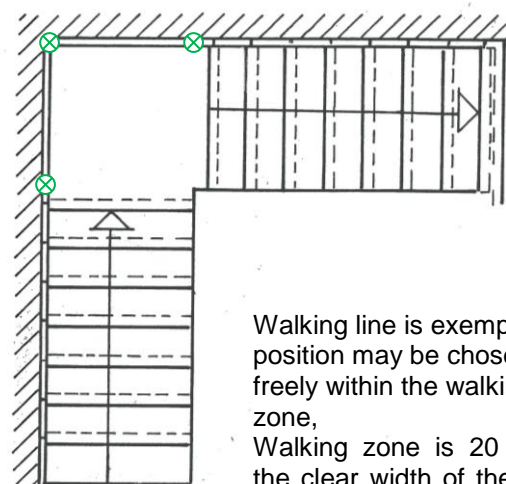
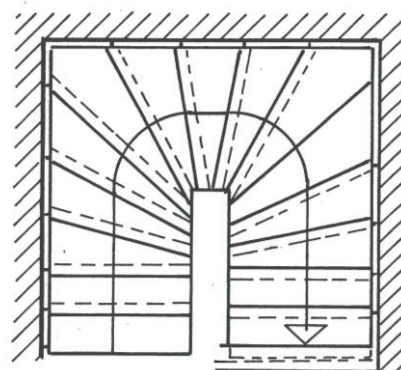
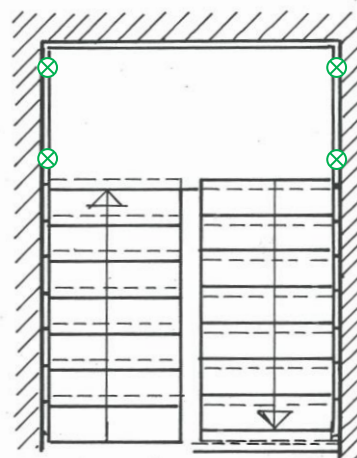
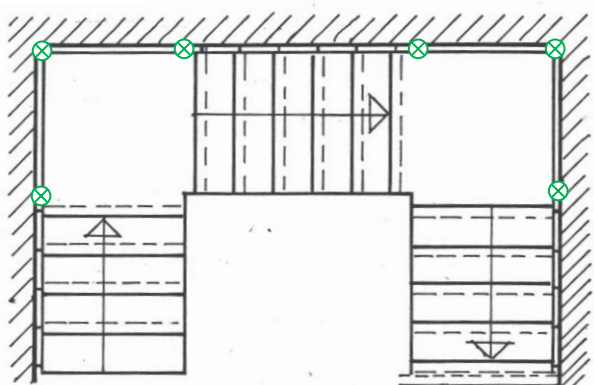
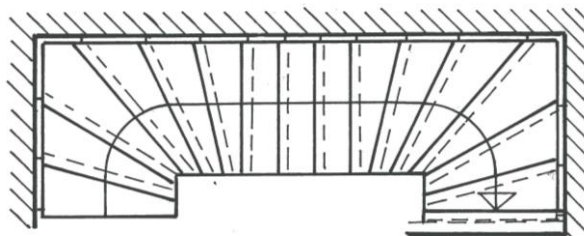
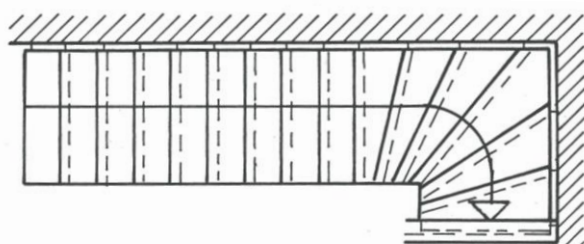
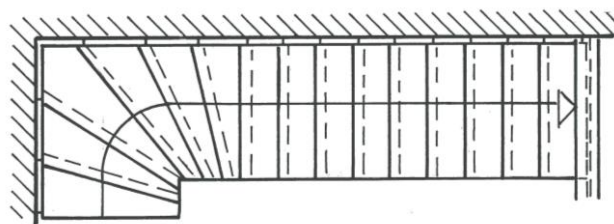
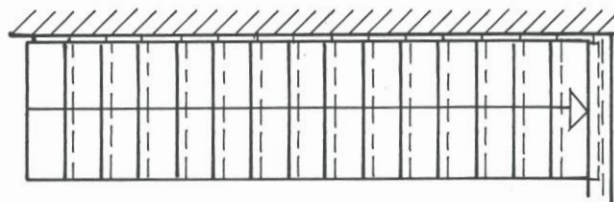

Walking line is exemplified,
position may be chosen
freely within the walking
zone,
Walking zone is 20 % of
the clear width of the stair
in the middle of the stair

⊗ Additional supports for vertical loads

"System Krieger" Stair

Product and intended use

Annex A1

Types of construction

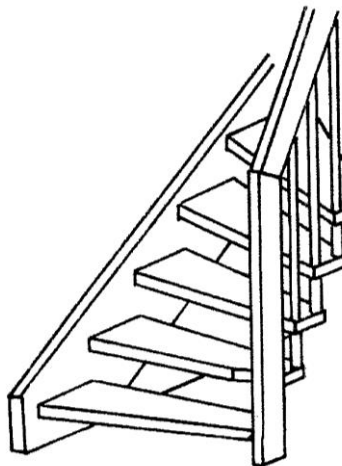
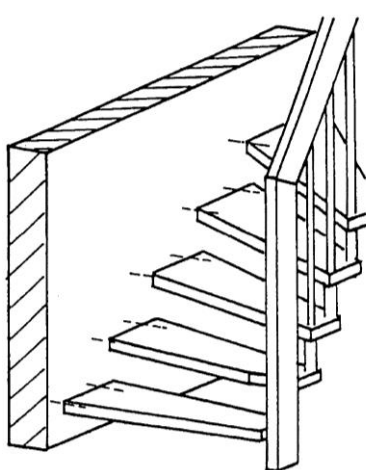

Horizontal wall fastening according to the technical documentation

System baluster

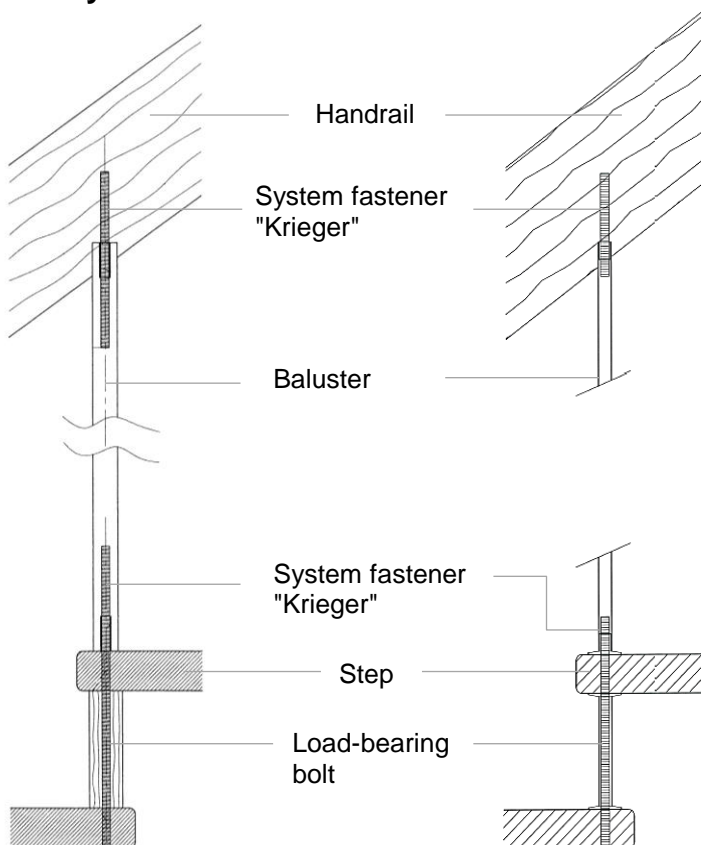

Wall ties

- Permanent elastic bearing sleeve
- Round steel \varnothing 16 mm
- Ferrule (for steps with a thickness of 42 mm and Steps made of merbau edge strengthening according to technical documentation)

Concrete or masonry

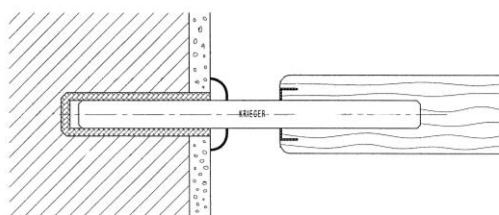

OSB

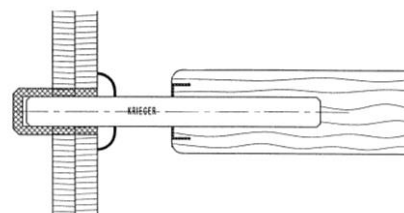

Minimum wall thickness and minimum strength of wall materials according to the technical documentation

"System Krieger" Stair

Types of construction, system baluster, wall ties

Annex A2

Post – handrail joint

screwed
Special screw
Wood species 1 and 2

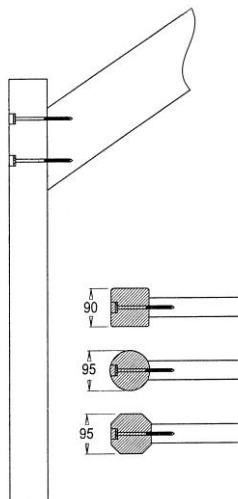

screwed
Stair screw
Wood species 1

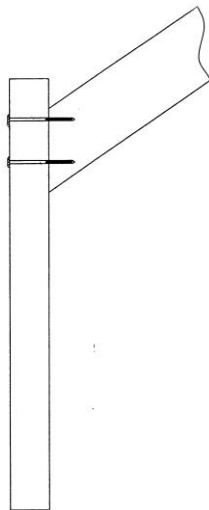

finger jointed

Wood species 1 and 2

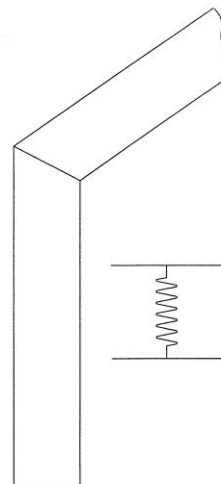

Handrail corner joint

Special screw (wood species 1 and 2)

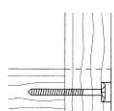
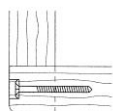
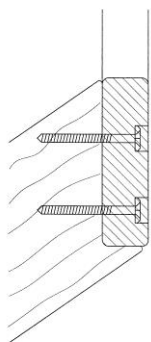
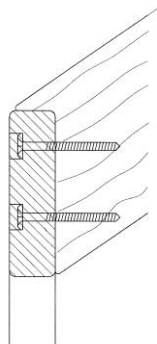

Stair screw (wood species 1)

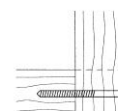
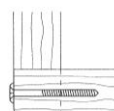
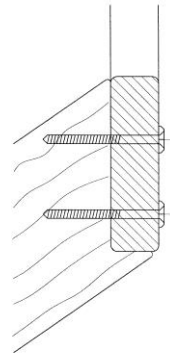
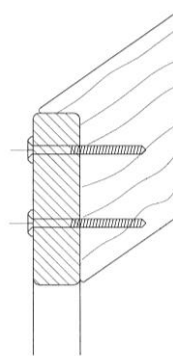

Handrail corner joint also possible as finger jointed string wreath

more details according to the technical documentation

"System Krieger" Stair

Post – handrail joint, handrail corner joint

Annex A3

Post joint at bottom

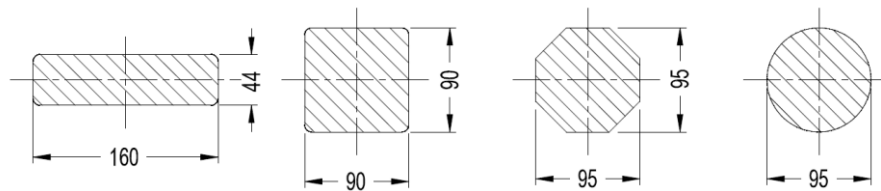
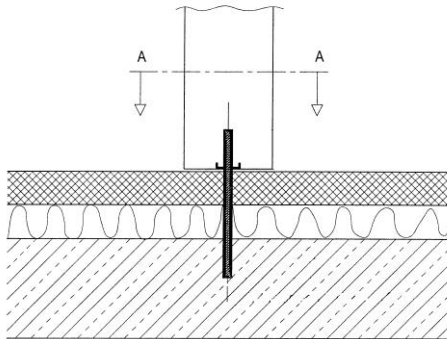

Post joint at the top

Post 160 / 55 (44) mm

Post 90 / 90 mm

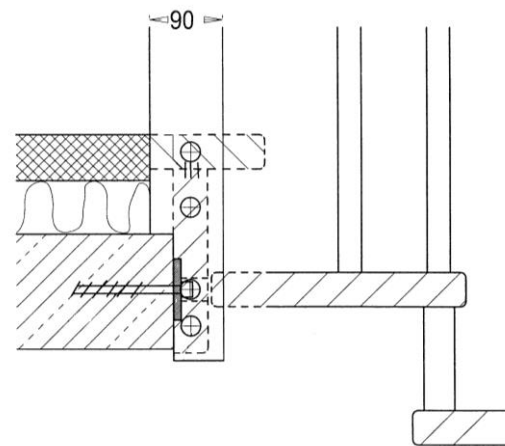
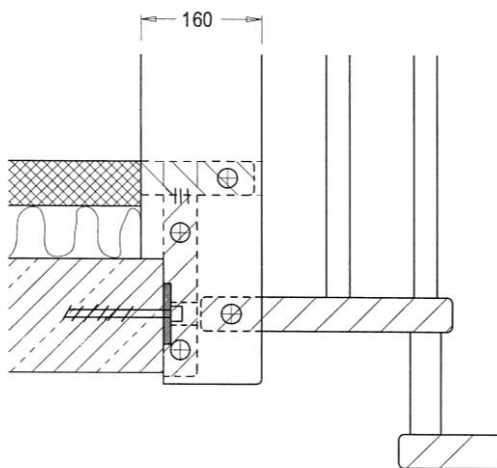

more details according to the technical documentation

"System Krieger" Stair

Post joint at bottom and at the top

Annex A4

Table 1: Components of stair: minimum dimension and material

Component of stair		Material ¹⁾	Dimension		Value	Reaction to fire	
Steps, landing slab	Wall tie: ferrule	Solid wood ³⁾	Thickness	[mm]	44 (45) ⁷⁾	D-s2, d0	
	Wall tie: ferrule + stiffening	Solid wood ²⁾	Thickness	[mm]	42 (44) ¹⁰⁾		
Step	Morticed in stringer	Solid wood ²⁾	Thickness	[mm]	42		
Landing beam		Steel	- ⁹⁾		- ⁹⁾	A1	
		Solid wood ¹⁾	- ⁹⁾		- ⁹⁾	D-s2, d0	
Upper flange of the railing, handrail	Straight flight with more than 10 rises only finger jointed	Solid wood ²⁾	Height / width	[mm]	160 / 55 (44) ⁸⁾	D-s2, d0	
	Other flights	Solid wood ²⁾	Height / width	[mm]	160 / 44	D-s2, d0	
Post	Straight flight with more than 10 rises only finger jointed	Solid wood ²⁾	Cross section a/b	[mm]	160 / 55 (44) ⁸⁾	D-s2, d0	
			Other flights	Solid wood ²⁾	Cross section a/b		[mm]
	Other flights		Solid wood ²⁾	Octagon inside circle	[mm]	95	D-s2, d0
				Diameter	[mm]	95	
Baluster		Solid wood ⁴⁾	Diameter	[mm]	30	D-s2, d0	
		Steel	Diameter	[mm]	16 (30) ⁵⁾	A1	
Load-bearing bolt – threaded rod		Steel	Diameter	[mm]	10	A1	
Load-bearing bolt – distance sleeve		Solid wood ⁴⁾	Diameter	[mm]	40	D-s2, d0	
		Steel	Pipe	[mm]	16 x 2	A1	
Load-bearing bolt - washer		Steel	Diameter / thickness	[mm]	40 / 4	A1	
System fastener		Steel	- ⁹⁾		- ⁹⁾	A1	
Wall ties		Round steel	Diameter	[mm]	16	A1	
			Embedment depth wall	[mm]	80 / 40 / 30 ⁶⁾		
			Embedment depth step	[mm]	80 (110) ⁷⁾		
Bearing sleeve (wall tie)		Plastic	Diameter	[mm]	25	Not relevant	
Stringer		Solid wood ¹⁾	Height / width	[mm]	320 / 45	D-s2, d0	

- 1) Characteristic values of materials according to the technical documentation
2) Only hardwood of the following species: wood species 1: beech, oak, maple, ash and wood species 2: nut tree, acacia, merbau
3) Only hardwood of the following species: wood species 1: beech, oak, maple, ash and wood species 2: nut tree, acacia
4) Only hardwood of the following species: wood species 1: beech, oak, maple, ash and wood species 2: nut tree, merbau
5) Value in brackets valid for railing banister
6) Embedment depth masonry: 80 mm, concrete: 40 mm, OSB: 30 mm
7) Value in brackets valid for wood species oak and ash
8) Value in brackets if handrail is fixed in height of the floor slab
9) Characteristic values according to the technical documentation
10) Value in brackets valid for wood species merbau

"System Krieger" Stair

Components of stair, minimum dimensions and reaction to fire

Annex A5

Specification of intended use (Part 1)

Intended use:

- European Technical Assessment applies for a construction system.
- For the specific case of use the corresponding type of stair is manufactured within the context of the values defined in this European Technical Assessment.
- Values of this ETA applies to all types of stairs, the real dimensions follow in accordance with the relevant case of use.

Stair subject to:

- Static and quasi static loads

Use conditions:

- Indoor stair
- Air temperatures between +5 °C and +30 °C
- Relative air humidity between 30% and 70%

Design:

- Design of the stair according to the annexes and the technical documentation of this European Technical Assessment.
- Fastening of the stair to the construction works according to the annexes and the technical documentation of this Technical European Assessment.
- Verification of the transmission of loads to the construction works by the civil engineer responsible for the construction works.
- Load bearing capacity at ultimate limit state:

$$q_k \cdot \gamma_Q \leq q_{RK} / \gamma_M$$

$$Q_k \cdot \gamma_Q \leq Q_{RK} / \gamma_M$$

$$h_k \cdot \gamma_Q \cdot \psi_0 \leq h_{RK} / \gamma_M$$

with

q_{RK}, Q_{RK}, h_{RK} : characteristic values of resistance; see Table 3

γ_M : recommended material partial safety factor; see Table 3

q_k, Q_k, h_k : characteristic values of imposed loads according to EN 1991-1-1:2002 + AC:2009

$\gamma_Q = 1.5$: recommended partial safety factor, in absence of other national regulations

$\psi_0 = 0.7$: recommended combination factor, in absence of other national regulations

- Maximum characteristic values of imposed loads under consideration of the partial factors mentioned above; see Table 5

"System Krieger" Stair

Specification of intended use (Part 1)

Annex B1

Specification of intended use (Part 2)

Installation:

- Installation by personal appropriately trained and authorized by the manufacturer by means of the technical documentation of this European Technical Assessment
- Installation only in the way as specified in the technical documentation of this European Technical Assessment
- Installation of timber components when moisture content of timber components is $8 \pm 2 \%$
- Sufficient support of the stair when assembling
- Installation of stair components without imposed deformations
- Installation of stair components without significant defects and cracks
- Replacing of stair components, which begin tearing when assembling
- Bolted connection are protected such that they will not be loosened by vibrations

Indication of the manufacturer:

- Ensure that all persons involved will be appropriately informed about the specific conditions according to sections 1 and 2 (including the annexes to which reference is being made as well as the not confidential parts of the technical documentation deposited to this European Technical Assessment)
- Packaging of timber components such that the wood moisture is $8 \pm 2 \%$ during transport and storage
- Instructions for use should provide information as to use, maintenance and repair of the stair. Including the information of avoidance of moisture penetration of the timber components and of retightens the bolting of the load-bearing bolts and connections according to Annexes A2 to A4 after the first heating season and the information on the relationship between moisture content of timber components, air temperature and relative air humidity

"System Krieger" Stair

Specification of intended use (Part 2)

Annex B2

Table 2: Geometry

Designation			Dimension	
			Minimum	Maximum
Going	step on walking line ¹⁾	[mm]	210	370 ²⁾
	tapered step	[mm]	60 ^{2) 3)}	600 ^{2) 4)}
Rise of the stairs ¹⁾		[mm]	140 ²⁾	210
Pitch of the walking line ¹⁾		[°]	21	45
Overlap of the steps		[mm]	40	- ⁵⁾
Number of risers		[-]	3	16
Openings	between barrier and other parts of the stair	[mm]	0	0
	between stairs and wall	[mm]	- ⁵⁾	50 (40) ⁷⁾
	between consecutive steps	[mm]	- ⁵⁾	168
	between balusters	[mm]	40	140 (520) ⁶⁾
clear width of stairs		[mm]	500	1000
Minimum headroom		[mm]	- ⁵⁾	
Length of the flight		[mm]	- ⁵⁾	4050
Thickness of steps		[mm]	42	- ⁵⁾
Height of the railing (barrier) / handrail		[mm]	850	1000
Handrail	width	[mm]	44	55
	height	[mm]	160	- ⁵⁾
	clear distance to adjacent components	[mm]	50	- ⁵⁾

- 1) values are constant within one flight
- 2) tolerance between nominal value and actual value = ± 5 mm
- 3) inside of tapered step
- 4) outside of tapered step
- 5) not relevant
- 6) value in bracket for railing banister
- 7) value in bracket for wood species merbau

- 1 going**
- 2 rise**
- 3 overlap**
- 4 opening between consecutive steps**
- 5 length of the flight**
- 6 thickness of steps**
- 7 height of the railing / barrier**
- 8 opening between balusters**

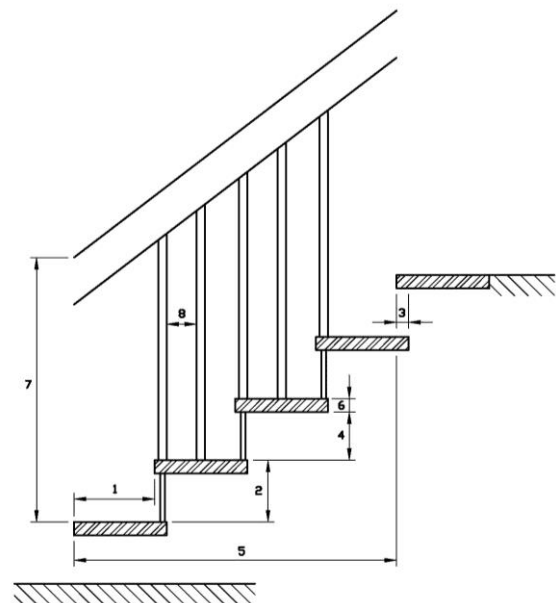

"System Krieger" Stair

Geometry of the stair

Annex C1

Table 3: Load-bearing capacity – Characteristic values of resistance

Component	Type of loading	Characteristic values of resistance			γ_M
Flight	vertical variable uniformly distributed load	$q_{R,k}$	[kN/m ²]	6.8	1.5 ¹⁾
	vertical variable single load	$Q_{R,k}$	[kN]	4.5	
	horizontal variable uniformly distributed load on barrier	$h_{R,k}$	[kN/m]	0.8	
Landing beam	vertical variable uniformly distributed load	$q_{R,k}$	[kN/m ²]	5.0	1.1 ²⁾
	vertical variable single load	$Q_{R,k}$	[kN]	3.3	

¹⁾ Recommended partial safety factor (wood decisive), in absence of other national regulations

²⁾ Recommended partial safety factor (steel decisive), in absence of other national regulations

Table 4: Deflections under loading

Deflection of the flight under uniformly distributed load			
uniformly distributed load	q_k	[kN/m ²]	3.0
length of the median line of the flight	L	[mm]	4050
deflection under load F_s related to the median line of the flight	w	[-]	≤ L/200
Deflection of the step under single point load			
single load	Q_k	[kN]	2.0
clear width of the stair	L	[mm]	1000
deflection under load F_s related to the clear width of the stair	w	[-]	≤ L/200

Table 5: Imposed loads

Type of loading	Imposed		
vertical variable uniformly distributed load	q_k	[kN/m ²]	3.0
vertical variable single load	Q_k	[kN]	2.0
horizontal variable uniformly distributed load on barrier	h_k	[kN/m]	0.5

"System Krieger" Stair

Load-bearing capacity – Characteristic values of resistance,
Deflections under loading,
Imposed loads

Annex C2